



# OWNER'S MANUAL

United States and Canada  
(Adjust-Pro Swim System)

SWIM PRO SPAS

2020



© 2020 LMS



[www.calspas.com](http://www.calspas.com)



# Table of Contents

Pre-Delivery Checklist . . . . .	2	<b>Cleaning and Maintenance</b>	
Planning the Best Location . . . . .	2	Removing and Reseating the Pillows . . . . .	63
Clearance for Service Access . . . . .	3	Jet Remove/Replace . . . . .	63
Preparing a Good Foundation . . . . .	3	Cleaning the Hydrostreamers . . . . .	63
240 Volt Electrical Installation . . . . .	3	Spa Cover and Locking System Installation . . . . .	64
Bleeding Air from the Pump . . . . .	12	Draining Your Portable Spa . . . . .	66
<b>Operating Your Spa</b>		Winterizing (Cold Climate Draining) . . . . .	67
Spa Operation for Pro-trainer - Variable Speed System Only . . . . .	13	Cleaning and Replacing the Filter . . . . .	67
Settings Screens . . . . .	15	Vacation Care . . . . .	67
Error Screens . . . . .	16	Cleaning Your Spa . . . . .	68
Swim Spa Workout Instructions . . . . .	16	Using the Freedom Sound System . . . . .	68
Swim Workout Programming . . . . .	17	<b>Keeping Fit With Your Swim Spa</b>	
NEO Settings for Cold Climates . . . . .	18	Air Injection System . . . . .	69
spaTouch Icon Driven Control Panel . . . . .	19	Swim Tether . . . . .	69
Changing Languages for the Display . . . . .	19	Exercise Equipment . . . . .	69
spaTouch3 and spaTouch4 Icon Driven Control Panel . . . . .	29	<b>Appendix</b>	
Cal Connect™ System . . . . .	44	Replacement Parts . . . . .	71
ATS Plus Therapy System . . . . .	54	Basic Troubleshooting . . . . .	75
Electrical Power Efficiency . . . . .	55	“Thermal Creep” . . . . .	76
Jets . . . . .	55	Limited Warranty . . . . .	77
LED Lighting . . . . .	55		
Diverter Knobs . . . . .	56		
Waterfalls . . . . .	56		
Air Venturis . . . . .	56		
Hydro Streamer Waterfall . . . . .	56		
<b>Water Clarity</b>			
The Key to Clear Water . . . . .	57		
Testing and Adjusting Spa Water . . . . .	58		
Sanitation . . . . .	59		
Bather Load . . . . .	60		
Filter Cleaning . . . . .	60		
Water Sanitation . . . . .	60		
Ozonator . . . . .	61		
Maintenance Schedule . . . . .	61		
Troubleshooting Water Clarity Problems . . . . .	62		

Copyright 2020 LMS. All rights reserved. Duplication without written consent is strictly prohibited.

Cal Spas®, Adjustable Therapy System™, ATS™, Cal Premium™, Cal Select™, Cal Stone™, Pure Cure™, XL™ Heater, and Ultimate Fitness Spa Series™ are registered trademarks.

Due to continuous improvement programs, all models, operation, and/or specifications are subject to change without prior notice.

LTR20201146, Rev. N  
4/7/21

## CONTACT INFORMATION

For customer service, please contact your authorized dealer immediately. If you need additional information and/or assistance, contact:

**LMS Customer Service Department**  
**1462 East Ninth Street**  
**Pomona, CA 91766.**

Toll Free: 1-800-CAL-SPAS  
Fax: 1-909-629-3890

# Important Safety Instructions

## READ AND FOLLOW ALL INSTRUCTIONS.

### DANGER -- Risk of accidental drowning:

Do not allow children to be in or around a spa unless a responsible adult supervises them. Keep the spa cover on and locked when not in use. See instructions enclosed with your cover for locking procedures.

### DANGER -- Risk of injury:

The suction fittings in this spa are sized to match the specific water flow created by the pump. Should the need arise to replace the suction fittings, or the pump, be sure the flow rates are compatible.

Never operate the spa if the suction fitting or filter baskets are broken or missing. Never replace a suction fitting with one that is rated less than the flow rate marked on the original suction fitting.

### DANGER -- Risk of electric shock:

Install the spa at least 5 feet (1.5 meters) from all metal surfaces. As an alternative, a spa may be installed within 5 feet of metal surfaces if each metal surface is permanently bonded by a minimum #8 AWG solid copper conductor to the outside of the spa's control box.

Do not permit any external electrical appliances, such as lights, telephones, radios, televisions, and etc., within five feet (1.5 meters) of the spa. Never attempt to operate any electrical device from inside the spa.

Replace a damaged power cord immediately.

Do not bury the power cord.

Connect to a grounded, grounding-type receptacle only.

### WARNING -- To reduce the risk of injury:

The spa water should never exceed 104°F (40°C). Water temperatures between 100°F (38°C) and 104°F (40°C) are considered safe for a healthy adult. Lower water temperatures are recommended for young children and when spa use exceeds 10 minutes.

High water temperatures have a high potential for causing fetal damage during pregnancy. Women who are pregnant, or who think they are pregnant, should always check with their physician prior to spa usage.

The use of alcohol, drugs or medication before or during

spa use may lead to unconsciousness, with the possibility of drowning.

Persons suffering from obesity, a medical history of heart disease, low or high blood pressure, circulatory system problems or diabetes should consult a physician before using the spa.

Persons using medications should consult a physician before using the spa since some medications may induce drowsiness while others may affect heart rate, blood pressure and circulation.

### HYPERTHERMIA DANGER:

Prolonged exposure to hot air or water can induce hyperthermia. Hyperthermia occurs when the internal temperature of the body reaches a level 3°F to 6°F above the normal body temperature of 98.6°F (or 2°C to 4°C above 37°C). While hyperthermia has many health benefits, it is important not to allow your body's core temperature to rise above 103°F (39.5°C).

Symptoms of excessive hyperthermia include dizziness, lethargy, drowsiness and fainting. The effects of excessive

hyperthermia may include:

- Failure to perceive heat
- Failure to recognize the need to exit spa or hot tub
- Unawareness of impending hazard
- Fetal damage in pregnant women
- Physical inability to exit the spa
- Unconsciousness

**WARNING:** The use of alcohol, drugs, or medication can greatly increase the risk of fatal hyperthermia.

**WARNING:** People with infectious diseases should not use a spa or hot tub.

**WARNING:** To avoid injury, exercise care when entering or exiting the spa or hot tub.

**WARNING:** Do not use drugs or alcohol before or during

the use of a spa or hot tub to avoid unconsciousness and possible drowning.

**WARNING:** Do not use a spa or hot tub immediately following strenuous exercise.

**WARNING:** Prolonged immersion in a spa or hot tub may be injurious to your health.

**CAUTION:** Maintain water chemistry in accordance with manufacturer's instructions.

## SAVE THESE INSTRUCTIONS.



# Preparing for Your New Spa

## Pre-Delivery Checklist

Most cities and counties require permits for exterior construction and electrical circuits. In addition, some communities have codes requiring residential barriers such as fencing and/or self-closing gates on property to prevent unsupervised access to the property by children. Your dealer can provide information on which permits may be required and how to obtain them prior to the delivery of your spa.

Before Delivery	
	Plan your delivery route
	Choose a suitable location for the spa
	Lay a 5 - 8 cm concrete slab
	Install dedicated electrical supply
After Delivery	
	Place spa on slab
	Connect electrical components

## Planning the Best Location

### Safety First

Do not place your spa within 10 feet (3 m) of overhead power lines.

### Consider How You Will Use Your Spa

How you intend to use your spa will help you determine where you should position it. For example, will you use your spa for recreational or therapeutic purposes? If your spa is mainly used for family recreation, be sure to leave plenty of room around it for activity. If you will use it for relaxation and therapy, you will probably want to create a specific mood around it.

### Plan for Your Environment

If you live in a region where it snows in the winter or rains frequently, place the spa near a house entry. By doing this, you will have a place to change clothes and not be uncomfortable.

### Consider Your Privacy

In a cold-weather climate, bare trees won't provide much privacy. Think of your spa's surroundings during all seasons to determine your best privacy options. Consider the view of your neighbors as well when you plan the location of your spa.

### Provide a View with Your Spa

Think about the direction you will be facing when sitting in your spa. Do you have a special landscaped area in your yard that you find enjoyable? Perhaps there is an area that catches a soothing breeze during the day or a lovely sunset in the evening.

### Keep Your Spa Clean

In planning your spa's location, consider a location where the path to and from the house can be kept clean and free of debris.

Prevent dirt and contaminants from being tracked into your spa by placing a foot mat at the spa's entrance where the bathers can clean their feet before entering your spa.

### Allow for Service Access

Make sure the spa is positioned so that access to the equipment compartment and all side panels will not be blocked.

Many people choose to install a decorative structure around their spa. If you are installing your spa with any type of structure on the outside, such as a gazebo, remember to allow access for service. It is always best to design special installations so that the spa can still be moved, or lifted off the ground.

## Clearance for Service Access

While you are planning where to locate your spa, you need to determine how much access you will need for service.

All spa models require a minimum of three feet / one meter access to all sides of the spa for potential service. For this reason, the spa should never be placed in a manner where any side is permanently blocked. Examples include placing the spa against a building, structural posts or columns, or a fence. Spa models require access to all sides in case they need service or repair. See the figure to the right. If you are planning to enclose or surround your spa with a deck, make sure there is easy access for service or repair. **Spas require clearance on all sides of the spa.**

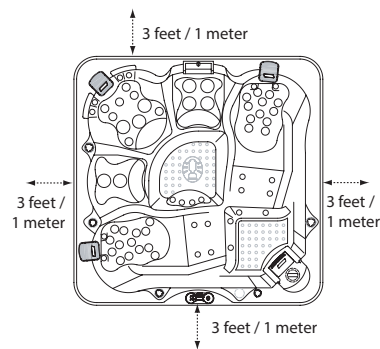

## Preparing a Good Foundation

Your spa needs a solid and level foundation. The area that it sits on must be able to support the weight of the spa, with water and the occupants who use it. If the foundation is inadequate, it may shift or settle after the spa is in place, causing stress that could **DAMAGE YOUR SPA SHELL AND FINISH.**

**Damage caused by inadequate or improper foundation support is not covered by the warranty. It is the responsibility of the spa owner to provide a proper foundation for the spa.**

Place the spa on an elevated 3 to 4" / 30 cm concrete slab. Pavers, gravel, brick, sand, timbers or dirt foundations are **not** adequate to support the spa.

We strongly recommend that a qualified, licensed contractor prepare the foundation for your spa.

If you are installing the spa indoors, pay close attention to the flooring beneath it. Choose flooring that will not be damaged or stained.

If you are installing your spa on an elevated wood deck or other structure, it is highly recommended that you consult a structural engineer or contractor to ensure the structure will support the weight of 150 pounds per square foot (732 kg / m<sup>2</sup>).

To properly identify the weight of your new spa when full, remember water weighs 8.33 lbs. per gallon, or 1 kg per liter. For example, an average 8' spa holds approximately 500 gallons, or 1892 liters, of water. Using this formula, you will find that the weight of the water alone is 4,165 lbs, or 1892 kg. Combined with the dry weight of the spa you will note that this spa will weigh approximately 5,000 lbs, or 2267 kg, when full of water.

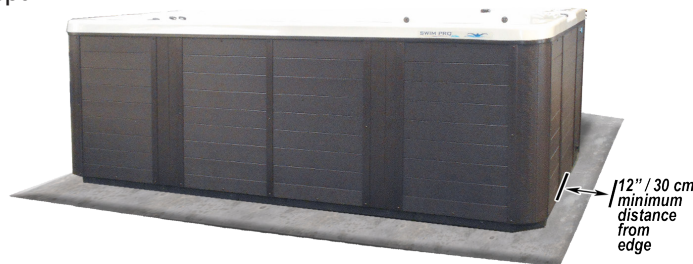

## 240 Volt Electrical Installation

All 240V spas must be permanently connected (hard wired) to the power supply. See the GFCI and wiring requirements starting on page 4.

**These instructions describe the only acceptable electrical wiring procedure. Spas wired in any other way will void your warranty and may result in serious injury.**

When installed in the United States, the electrical wiring of this spa must meet the requirements of NEC 70 and any applicable local, state, and federal codes.

**The electrical circuit must be installed by an electrical contractor and approved by a local building or electrical inspector.**

**Failure to comply with state and local codes may**

**result in fire or personal injury and will be the sole responsibility of the spa owner.**

The power supplied to the spa must be on a dedicated GFCI protected circuit as required by NEC 70 with no other appliances or lights sharing the power.

Use copper wire with THHN insulation. Do not use aluminum wire.

Use the table below and on the next page to determine your GFCI and wiring requirements.

Wires that run over 100 feet must increase wire gauge to the next lower number. For example: A normal 50 amp GFCI with four #6 AWG copper wires that run over 100 feet would require you to use four #4 AWG copper wires.

## GFCI and Wiring Requirements

**Applies to all fitness spas except F-1781**

**Standard configuration with one 5.5 kW heater**

Spa Model	Control System	GFCI Required	Wires Required	Wiring Diagram
F-1222	BP501G1	One 50 amp GFCI	Four #6 AWG copper wires	Use wiring diagram (see page 8)
F-1325	BP501G1	One 50 amp GFCI		
F-1421	BP501	One 50 amp GFCI		
F-1437	BP501X	One 50 amp GFCI		
F-1537	BP20X	One 60 amp GFCI		
F-1641	BP20X	One 60 amp GFCI		
F-1681	BP20X	One 60 amp GFCI		

**Configuration (auxiliary 5.5 kW heater)**

Spa Model	Control System	GFCI Required	Wires Required	Wiring Diagram
F-1325, F-1421	BP501X	One 50 amp GFCI & one 40 amp GFCI	Four #6 AWG copper wires	Use wiring diagram (see page 8)
F-1641, F-1681, F-1896	BP20X	One 60 amp GFCI & one 40 amp GFCI	Four #6 AWG copper wires	Use wiring diagram (see page 8)

**Configuration (Includes F-1781)**

Spa Model	Pro-Trainer System	Control System	GFCI Required	Wires Required	Wiring Diagram
F-1325PT	SP2	NEO 2100	SIEMENS 60 amp breaker	Four #6 AWG copper wires	Use wiring diagram (see page 6)
F-1681	SP3	NEO 2100	SIEMENS 60 amp breaker		
F-1421	SP2	NEO 2100	SIEMENS 60 amp breaker		
F-1641	SP3	NEO 2100	SIEMENS 60 amp breaker		
F-1781	SP3	NEO 2100	SIEMENS 60 amp breaker		

**Applies to model F-1781 only**

**Standard configuration with one 5.5 kW heater**

Control System	Spa Side	GFCI Required	Wires Required	Wiring Diagram
BP501G1	Service (spa side)	One 40 amp GFCI	Four #8 AWG copper wires	Use wiring diagram (see page 8)

**Configuration for Option OPT20-200 (auxiliary 5.5 kW heater)**

Control System	Spa Side	GFCI Required	Wires Required	Wiring Diagram
BP20X	Service 1 (swim side)	One 60 amp GFCI	Four #6 AWG copper wires	Use wiring diagram (see page 8)
	Service 2 (swim side)	One 40 amp GFCI	Three #8 AWG copper wires	

# Circuit Board Connection (60 Hz) - NEO US & Canada

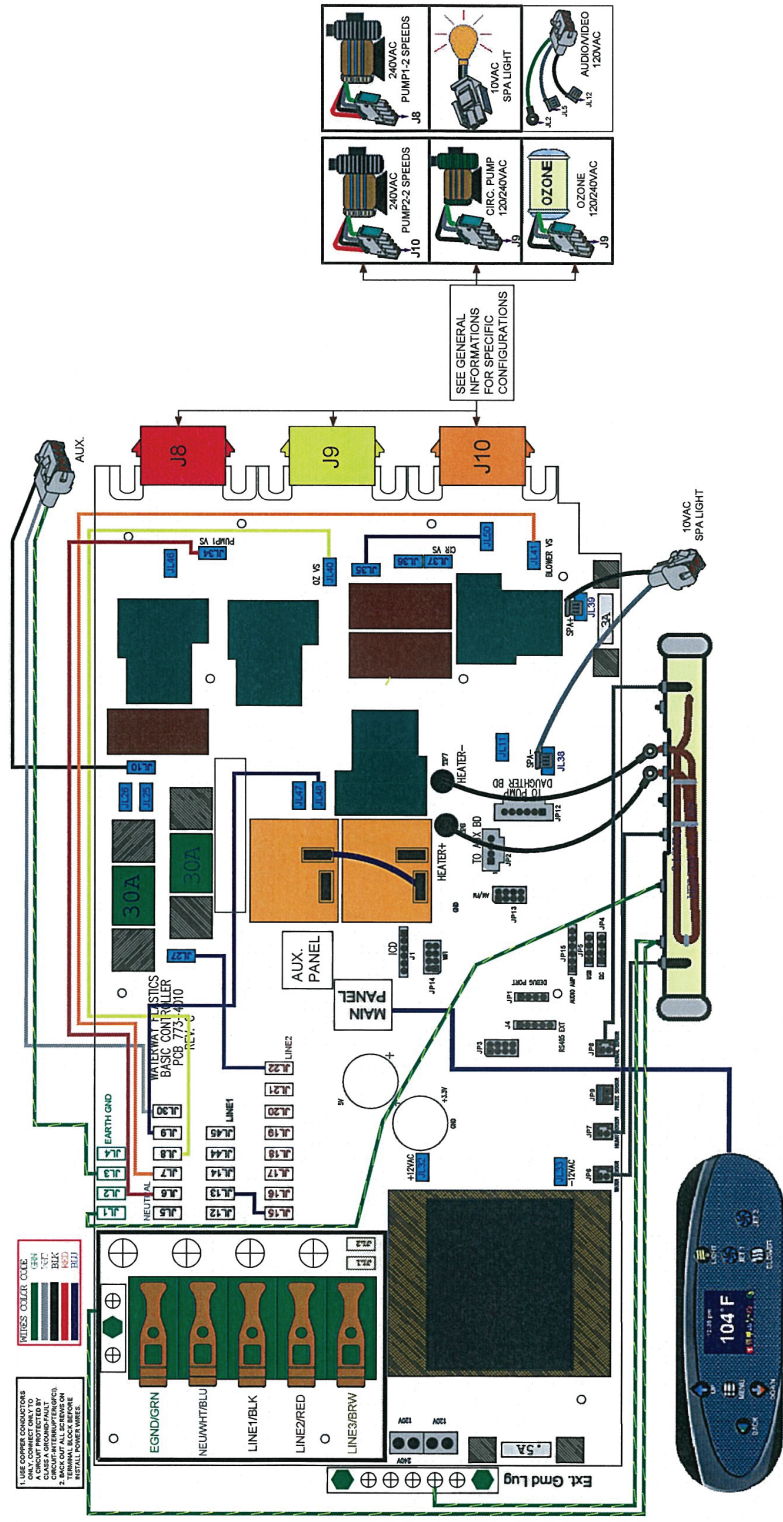

# Circuit Board Connection (50 Hz) - NEO US & Canada

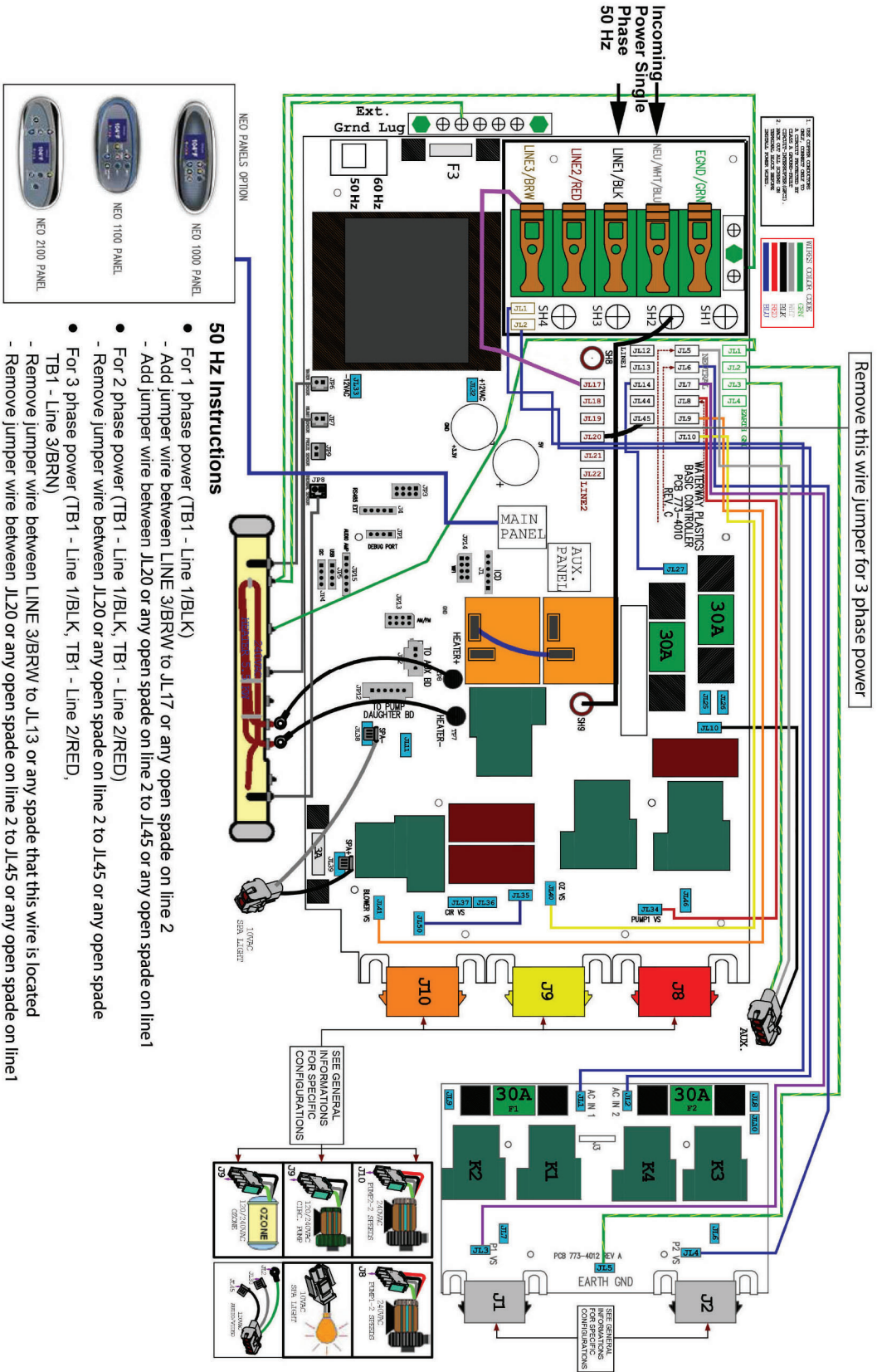



# European Wiring Configuration (NEO)

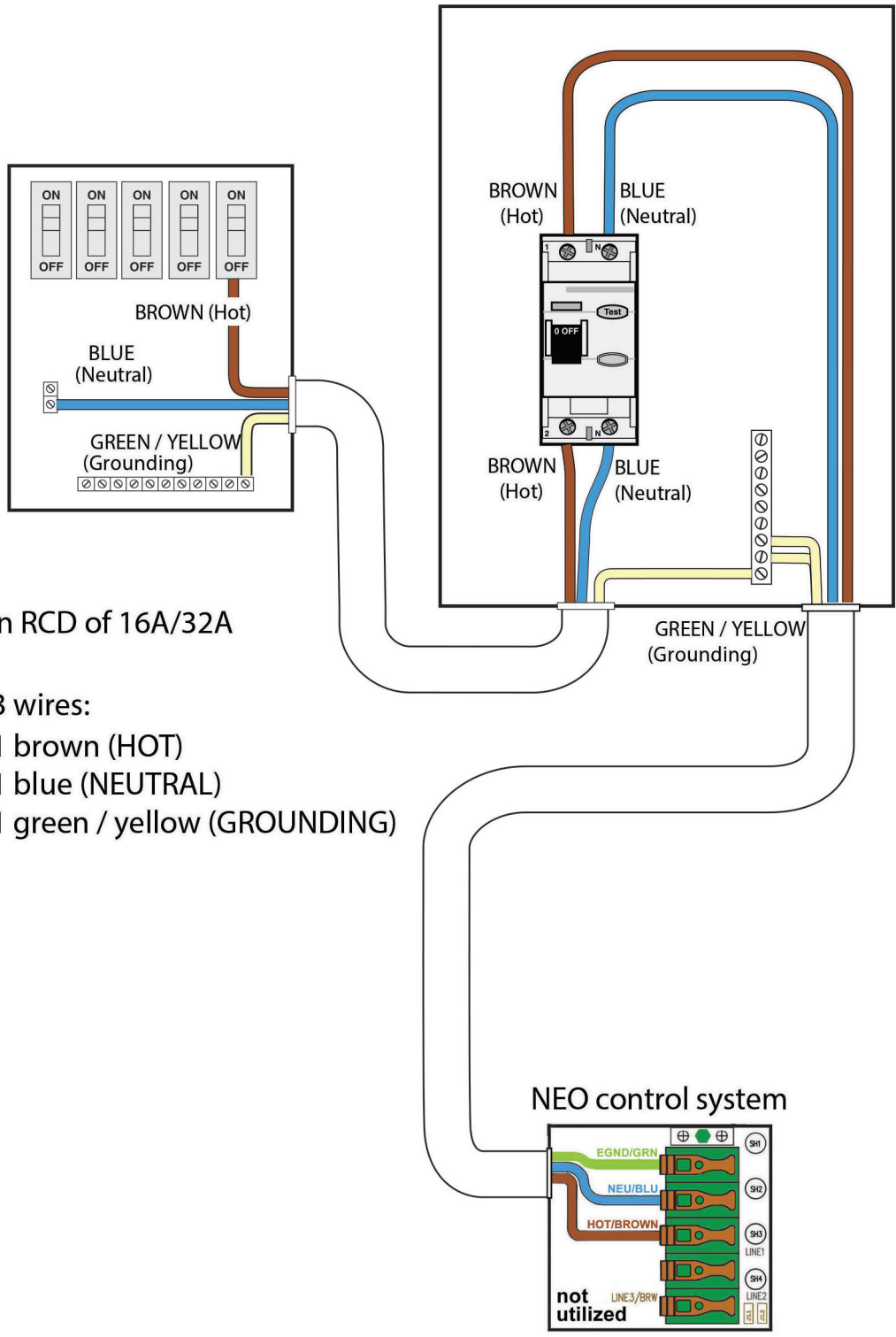

An RCD of 16A/32A

- 3 wires:  
 1 brown (HOT)  
 1 blue (NEUTRAL)  
 1 green / yellow (GROUNDING)

# Wiring Diagram for US & Canada (Balboa)

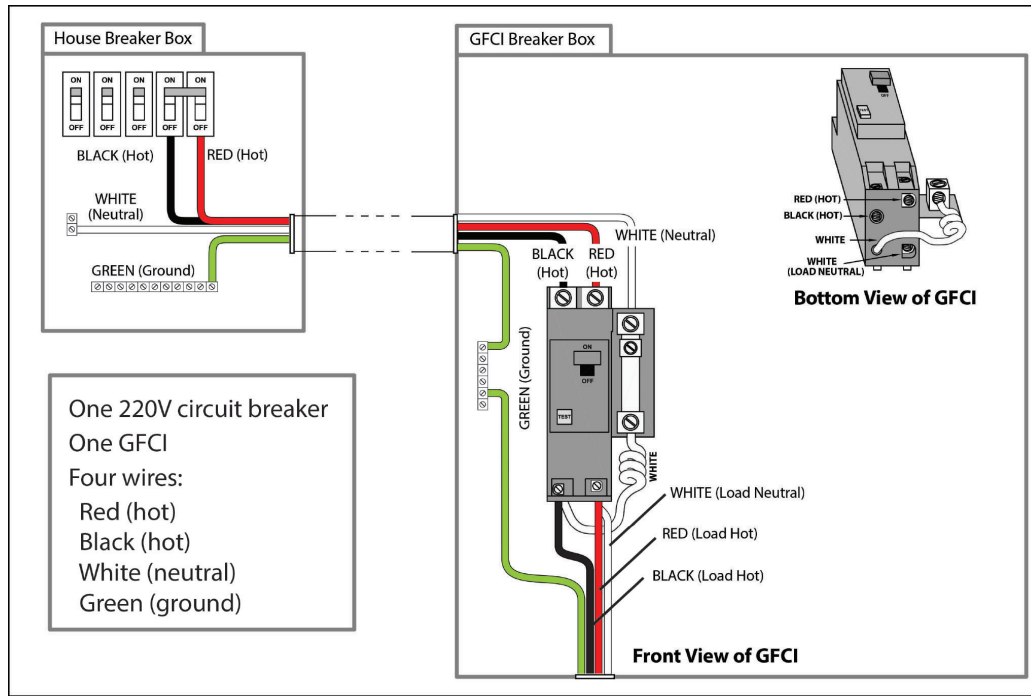

# Wiring Diagram for Europe (Balboa)

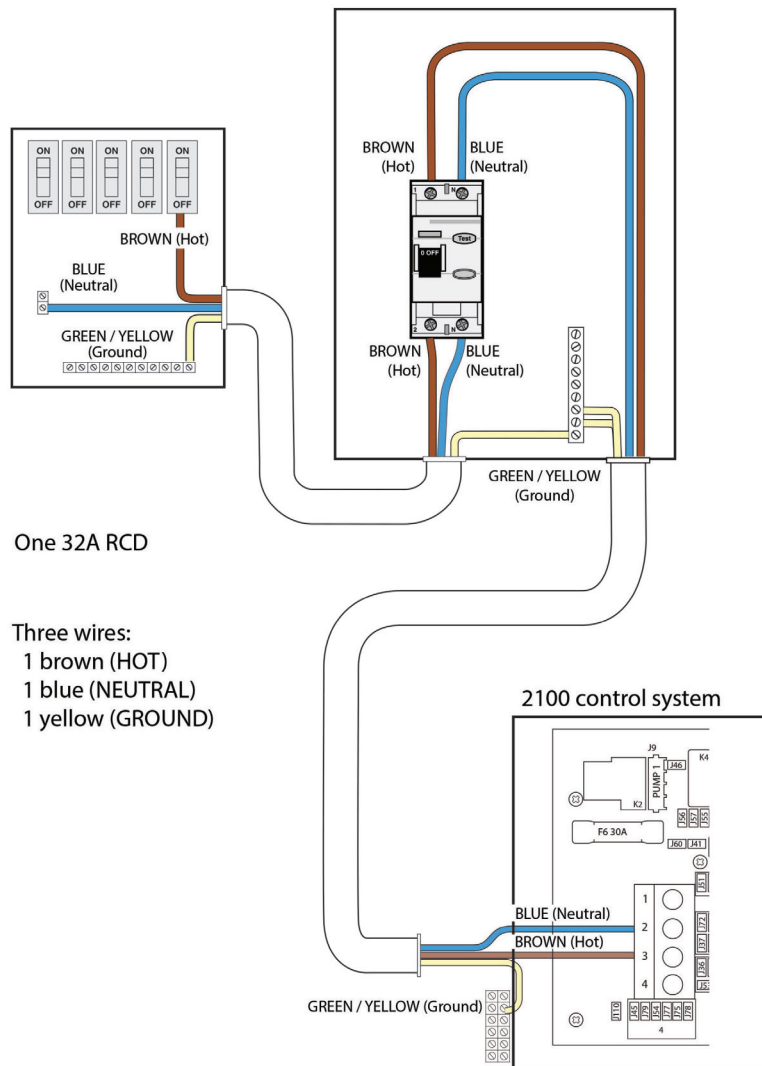



# Filling and Powering Up Your Portable Spa

## 1. Inspect the spa equipment.

Inspect all plumbing connections in the equipment area of your spa.

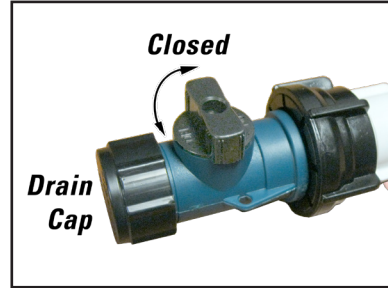
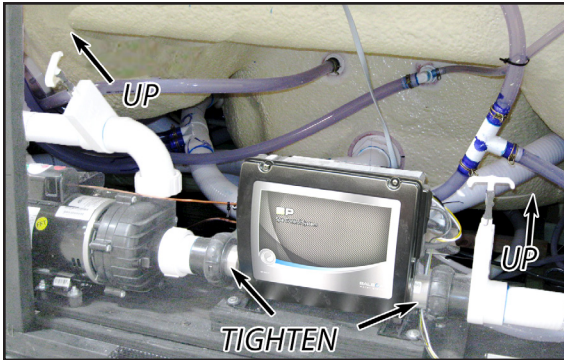
- Make sure unions in the equipment pack are tight. (Be careful not to over-tighten the plumbing fittings.)
- If your spa has gate valves, make sure they are all in the UP or OPEN position.
- Make sure the drain valve is closed and capped. (See page 66 for a description of drain valves.)



 Never run the spa with the gate valves closed or without water circulating for long periods of time.

## 2. Remove the cartridge from filter canister.

### If you have a skimmer like this:

Grip the filter by the handle and unscrew it from the canister. Never try to pull the filter cartridge while the spa is running in low or high speed (i.e., any speed).



### If you have a skimmer like this:

Remove the black skimmer cap and barrel, grip the filter by the handle and unscrew it from the canister.



- Teleweir Mega filter skimmer**
- 75 square feet filtration
  - Smooth cap

### If you have a skimmer like this:

Rotate and remove the black locking ring. Remove the black skimmer cap and barrel, grip the filter by the handle and unscrew it from the canister. Replace and lock the locking ring and slide the skimmer cap and barrel back in the canister.

Note: The skimmer cap and barrel were locked in place at the factory to prevent damage during shipment. It must be unlocked and replaced in the filter canister so that it can float when the spa is filled. If you do not remove the cap and barrel, your spa's filtration system will not perform as it was designed to.



### Teleweir filter skimmer

- 50 square feet filtration
- Spoked cap

 After you remove the filter, remove the plastic wrapper and soak it in water for 30 minutes before you replace it. A dry filter can allow air into the filtration system which can cause the pump to fail to prime.

### 3. Fill the spa.

Place a garden hose in the filter canister and fill your spa.

**Always fill the spa through the filter canister.** Failure to do so may cause air to be trapped in the filtration system and prevent the pumps from operating properly.



Fill the spa until water level is about six inches from the top.

If the water level is too low or too high, your spa will not operate properly.

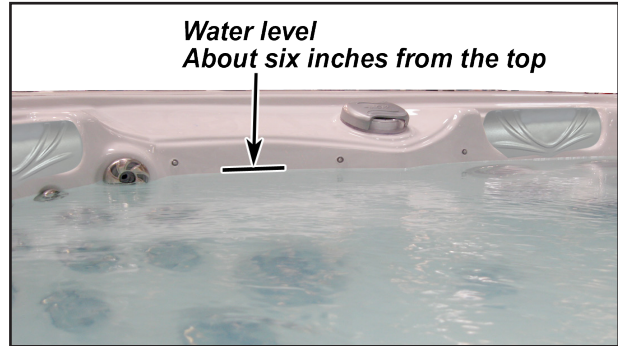

#### **Never fill your spa with soft water.**

Soft water makes it impossible to maintain the proper water chemistry and may cause the water to foam, which will ultimately harm the finish of the spa and void your warranty.

You may fill your spa with **well water provided the following conditions are met:** 1) Purchase and use a pre-filter to run the well water through on the fill-up. The pre-filter will be placed before the spa filter in the fill-up flow of water. 2) Have a Total Dissolved Solids (TDS) and metals test performed by a qualified person after the fill-up process but before any spa use.

### 4. Turn on power to the spa.



When the spa is filled to the correct level, turn on the power at the GFCI breaker. (Ensure that the 120V spas are connected to the proper electrical outlet.)

### 5. Prime the pump.

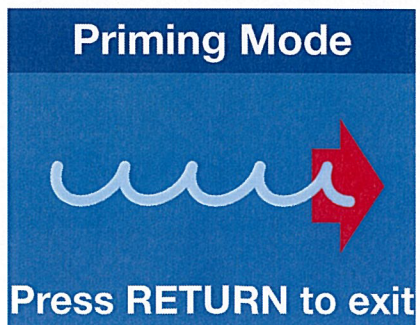

**For Waterway Systems.** The system will enter the priming mode. **Priming Mode** will display on the control panel. In Priming Mode, all devices such as jets and lights are operable. Jets can be turned on and off to help prime the pump. The system will exit Priming Mode and go to the Main display when the RETURN button is pressed, or after four minutes of activity.

### Priming for Balboa Systems.

#### Priming Mode – M019

After the initial start-up sequence, the control will enter Priming Mode and display a Priming Mode screen. Only pump icons appear on the priming mode screen. During the priming mode, the heater is disabled to allow the priming process to be completed without the possibility of energizing the heater under low-flow or no-flow conditions. Nothing comes on automatically, but the pump(s) can be energized by selecting the “Jet” buttons. If the spa has a Circ Pump, it can be turned on and off by pressing the “Circ” button during Priming Mode.

#### 6. Install the filter into the filter canister.

 Make sure the filter has soaked at least 30 minutes before you install it. Insert the filter all the way and screw it in. Do not over-torque the cartridge during installation, just hand tighten gently.



#### 7. Adjust water chemistry.

Test and adjust the water chemistry. See the section on page 57 for instructions on keeping your water clear.

#### 8. Let the spa heat up.

When the spa has finished priming, the heater will activate. Put the cover on and let the spa heat to the set temperature.

### Priming the Pump

New spa owners often have difficulty the first time they start their spa and the pump fails to prime. This can be frustrating, but these simple instructions can help you.

Sometimes air can become trapped in the pump while filling the spa. You will know this has happened when after you have filled and started the spa, the pump does not seem to function. You will hear the pump operating, but no water will be moving.

 The pump will not work properly while air is trapped in it. Continuing to operate the pump in this way will cause damage.

#### Starting Up: Priming Mode for Waterway Systems

**For Waterway Systems.** The system will enter the priming mode. **Priming Mode** will display on the control panel. In Priming Mode, all devices such as jets and lights are operable. Jets can be turned on and off to help prime the pump. The system will exit Priming Mode and go to the Main display when the RETURN button is pressed, or after four minutes of activity.

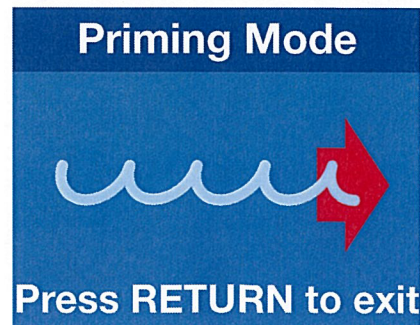

## Exiting Priming Mode for Waterway Systems

You can manually exit Priming Mode by pressing the RETURN button. Note that if you do not manually exit the priming mode, the priming mode will be automatically terminated after 4 to 5 minutes. Be sure that the pumps have been primed by this time.

## Starting Up: Priming Mode for Balboa Systems

### Priming Mode – M019

After the initial start-up sequence, the control will enter Priming Mode and display a Priming Mode screen. Only pump icons appear on the priming mode screen. During the priming mode, the heater is disabled to allow the priming process to be completed without the possibility of energizing the heater under low-flow or no-flow conditions. Nothing comes on automatically, but the pump(s) can be energized by selecting the “Jet” buttons. If the spa has a Circ Pump, it can be turned on and off by pressing the “Circ” button during Priming Mode.

## Automatic Exiting of Priming Mode for Balboa Systems

The system will automatically enter the normal heating and filtering at the end of the priming mode, which lasts 4-5 minutes.

— — — — °F      — — — — °C

## Bleeding Air from the Pump

If you have tried priming the pump several times unsuccessfully using the control panel, you can bleed the air from the pump manually.

1. Shut off the power to the spa.
2. Using a Phillips screwdriver, remove the front panel from the spa and locate the pump.
3. Close the gate valve on the discharge side of the pump (if your spa is installed with one.)
4. Turn the bleeder valve counter clockwise with a small pair of pliers until the air has been released from the pump.
5. If this is unsuccessful, loosen the union nut on side of the pump with channel locks. When air is bled out, tighten the nut.
6. Turn on power to the spa and press the JETS button. If there is still air trapped in the pump, repeat steps 2 through 5 until the pump primes.

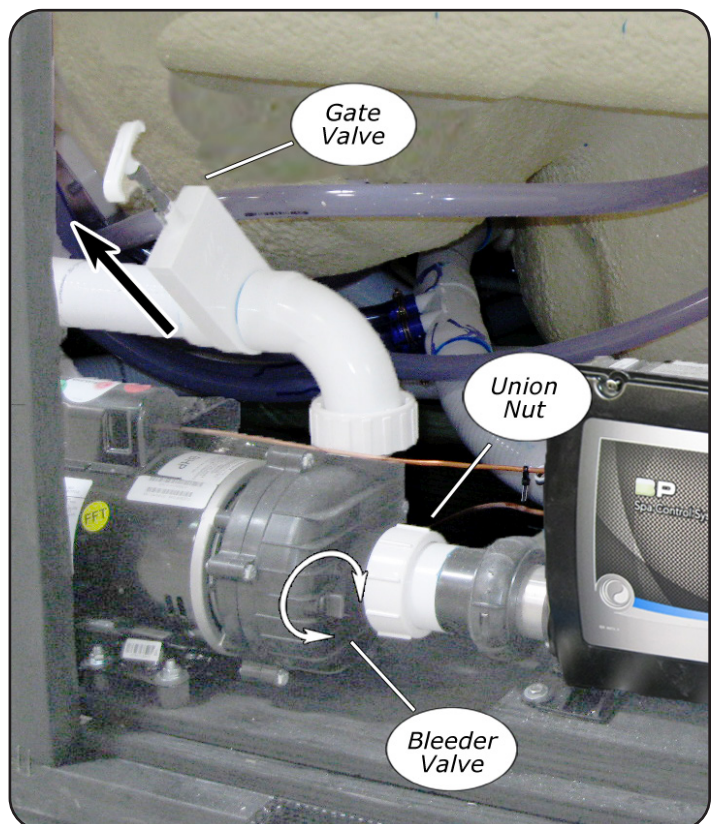

## Spa Operation for Pro-trainer - Variable Speed System Only

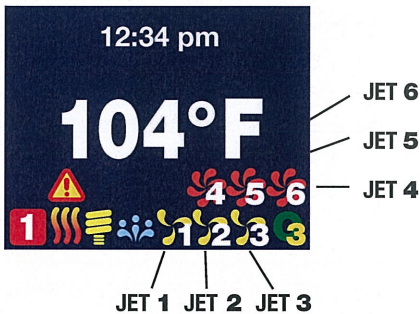

### MAIN SCREEN:

The main screen displays current time, water temperature, and status of the system accessories. The screen below from bottom, left to right indicates LIGHT ON, BLOWER ON, JET 1 at low speed, and JET 2 at high speed.



### PRIMING MODE:

When power is ON, the system will enter a priming mode with priming screen display on the panel. In this mode, all devices such as JETS, BLOWERS or LIGHT are operable. JETS can be turned on and off to prime the pump. System will exit priming mode and go to MAIN display when RETURN button is pushed, or after 4 minutes of inactivity.

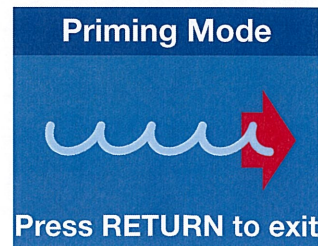

### SPA OPERATION:

Turn system accessories ON and OFF by pushing appropriate button on the right side of panel (LIGHT, JET 1, BLOWER, JET 2...) These accessories have timeout defaults from the manufacturer and will turn OFF automatically after the time has expired. Timeout time for LIGHT default is 60 minutes; BLOWER default is 15 minutes; JET at low speed default is 60 minutes; and JET at high speed is 15 minutes. User can change these default times in "DEVICE TIMEOUT" setting menu.









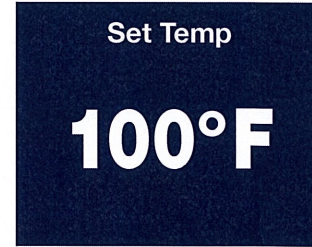









**MENU NAVIGATING:**

- MENU button: use to enter setting menu and sub-menu screens. For screens with several settable fields (example: DATE-TIME screen), use MENU button to navigate between different fields within the screen.
- UP and DOWN button: use to navigate between different options or changing values of a field.
- RETURN button: use to confirm the setting and goes back to previous screen.

**SETTING TEMPERATURE:**

To change water set temperature, use UP and DOWN buttons to set the desired temperature. The screen will display "SET TEMP" with the current set temperature. After 5 seconds without any change to the set temperature, the screen will reverse back to MAIN screen with current water temperature display. Changing set temperature will make heat pump turn on to get accurate water temperature to determine if water needs to be heated up.

**SELECTION ICONS:**

 FILTER CYCLE 1	 ENERGY SAVING HEAT MODE	 OZONE ON
 FILTER CYCLE 2	 VACATION HEAT MODE	 JET ON LOW SPEED
 FILTER CYCLE 3	 CLEANER CYCLE	 JET ON HIGH SPEED
 FILTER CYCLE 4	 POLLING CYCLE	 BLOWER ON
 LIGHT ON	 TEMPERATURE LOCK	 SPECIAL TEMP SELECT
 HEATER ON	 PANEL LOCK	 OPTION
 HEATER START-UP		

**PANEL TIMEOUT:**

If user is in Setting Menus and no button is pushed within 15 seconds, the screen will timeout, current screen setting will be lost and panel reverts back to MAIN screen.

In MAIN screen, if no buttons is pushed within 60 minutes, all LED and LCD lights will turn off and panel goes to sleep. Any button pushed in this time will wake the panel up, LED and LCD lights will turn back on and panel will poll for water temperature.

**ENTER SETTING SCREENS:**

Press MENU button to display a list of set up screens.

Use UP and DOWN to navigate between various set up screens.

Press MENU again to enter a particular set up screen or press RETURN to goes back to MAIN screen.

Rotate View  
Special Temp  
Heat Mode  
Filter Cycles  
Date-Time

Rotate View  
Special Temp  
Heat Mode  
Filter Cycles  
Date-Time



## Settings Screens

- **ROTATE VIEW:** rotate the view 180 degrees, the UP and DOWN buttons also swap when rotated. With ROTATE VIEW highlighted, press MENU to enter ROTATE VIEW setting. Use UP/DOWN to select desired setting and RETURN to exit and confirm the setting.
- **SPECIAL TEMP:** to temporarily heat spa to 105°F or 106°F once, and return to previous temperature setting. With SPECIAL TEMP highlighted, press MENU to enter SPECIAL TEMP setting. Use UP/DOWN to select the desired setting and RETURN to exit and confirm the setting.
- **HEAT MODE:** select STANDARD heating mode for most users or ENERGY SAVING mode (reduces polling for water temperature) or VACATION mode (set temp set to 60°F). With HEAT mode highlighted, press MENU to enter HEAT mode setting. Use UP/DOWN to select the desired setting and RETURN to exit and confirm the setting.
- **FILTER CYCLES:** set up filter cycle START TIME, DURATION and DATE for filtering the spa. For FILTER CYCLE 1 and 2, if DURATION is set to ZERO the system will do a purge cycle at the start time setting. With FILTER CYCLE highlighted, press MENU to enter FILTER CYCLE 1, 2, 3, or 4 setting. Select a FILTER CYCLE and press MENU again to enter TIME/DURATION setting screen. In this screen, press MENU to move between HOURS, MINUTES and DAYS setting; use UP/DOWN to change the values and RETURN to exit and confirm the setting. FILTER CYCLES 3 & 4 default OFF. To select it, enter START TIME, DURATION and enable ALL DAY or specific day for both FILTER CYCLES 3 & 4.
- **DATE-TIME:** set up date and time for the spa. With DATE-TIME highlighted, press MENU to enter DATE-TIME setting. In this screen, pressing MENU will move and highlight various fields that can change the setting; UP/DOWN to change the values and RETURN to exit and confirm the setting.
- **DEGREE F/C:** displays spa temperature in Celsius or Fahrenheit. This option is only available for 60 Hz countries. Unit automatically displays Celsius for 50 Hz. With DEGREE F/C highlighted, press MENU to enter DEGREE F/C setting. Use UP/ DOWN to select the desired setting and RETURN to exit and confirm the setting.
- **TIME DISPLAY:** displays spa time in AM/PM or 24 hours time. With TIME DISPLAY highlighted, press MENU to enter TIME DISPLAY setting. Use UP/DOWN to select the desired setting and RETURN to exit and confirm the setting.
- **DEVICES TIMEOUT:** allows changes to timeout setting for various devices. LIGHT can be set to a maximum of 4 hours; PUMP in high speed and BLOWER can be set to a maximum of 1 hour; and PUMP in low speed can be set to a maximum of 2 hours. With DEVICES TIMEOUT highlighted, press MENU to enter and select various devices setting. Use UP/DOWN to select the desired time setting and RETURN to exit and confirm the setting.
- **PANEL LOCK:** provides a choice to lock out panel buttons.
  - 1) Press MENU
  - 2) Use COOL (also known as Down button) to get to the PANEL LOCK option
  - 3) Press MENU button to select, then scroll down to the MENU option
  - 4) Press RETURN button to confirm this selection
  - 5) Press RETURN button again – to resume to the Temperature screen.

**At this point, the spa user is locked out of changing menu options.**











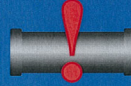

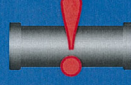
**To cancel MENU LOCK and resume all spa control functions, perform the following procedure:**

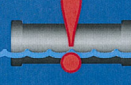
- 1) Turn off the circuit breaker supplying mains power to the SpaPak and wait 10 seconds
- 2) Turn back on the circuit breaker supplying mains power to the SpaPak.
- 3) Wait for the topside to start up.
- 4) When the screen displays, "Priming Mode .... Press Return to exit", **do not press Return; press the Menu button instead.**
- 5) Step through the menu to the Panel Lock entry. (The screen should now show Panel Lock at the top, and Menu Lock highlighted below).
- 6) Press the WARM (also known as Up button) until **Off** is highlighted.
- 7) Press the RETURN button.

**MENU LOCK is now cancelled.**

- **NO HEAT TIME:** set the time frame for not allowing heater to turn on. With NO HEAT TIME highlighted, press MENU to enter NO HEAT TIME setting. In this screen, pressing MENU will move and highlight various fields that can change the setting; use UP/DOWN to change the values and RETURN to exit and confirm the setting.
- **SERVICE MODE:** *only available for Authorized Dealers and Spa Manufacturer.*
- **DEMO MODE:** to demonstrate all device capabilities of the spa. With DEMO MODE highlighted, press MENU to enter MODE setting. Use UP/DOWN to select the desired setting and RETURN to exit and confirm the setting.
- **GENERAL INFORMATION:** displays general information for the spa. With GENERAL INFORMATION highlighted, press MENU to enter GENERAL INFORMATION menu. Use UP/DOWN to view different pages and information and RETURN to exit the page. Screen will indicate which plug should be inserted to correct side connector.
- **LANGUAGES:** to select various languages for the spa display. With LANGUAGES highlighted, press MENU to enter and select a specific language. Use UP/DOWN to select the desired setting and RETURN to exit and confirm the setting.
- **SERENITY MODE:** set to turn off all outputs and provide quiet while in spa. With SERENITY MODE highlighted, press MENU to enter and select a specific time. Use UP/DOWN to select the desired time setting. Press MENU again to navigate to EXIT/START. Select the desired option and RETURN to exit and confirm the setting.
- **ENERGY INTERVAL:** *only available for Non-Circ systems.* With ENERGY INTERVAL highlighted, press MENU to enter ENERGY INTERVAL setting. Use UP/DOWN to select the desired minutes setting and RETURN to exit and confirm the setting.
- **CLEANER CYCLE:** *only available for Non-Circ systems.* To turn on filtration after using the spa for short cleaning period. With CLEANER CYCLE highlighted, press MENU to enter and select a specific duration. Use UP/DOWN to select the desired time setting. Press Menu again to navigate to Exit/Start. Select the desired option and RETURN to exit and confirm the setting.
- **Reset Wi-Fi:** *only available with Wi-Fi module in the system.* To reset Wi-Fi network setting in Wi-Fi module. With RESET Wi-Fi highlighted, press MENU to enter. Use UP/DOWN to select the desired setting and RETURN to exit and confirm the setting.

# Error Screens

<div style="background-color: #0056b3; color: white; padding: 5px; text-align: center;"><b>Plumbing Error</b></div>  <div style="background-color: #0056b3; color: white; padding: 5px; text-align: center;">Press RETURN to clear</div>	<p>◀ Error caused when SENSOR 1 and SENSOR 3 have been plugged in incorrectly. Swap the SENSOR 1 and SENSOR 3 plug in controller to correct this problem.</p>	<div style="background-color: #0056b3; color: white; padding: 5px; text-align: center;"><b>Sensor 1 open</b></div>  <div style="background-color: #0056b3; color: white; padding: 5px; text-align: center;">Press RETURN to clear</div>
<div style="background-color: #0056b3; color: white; padding: 5px; text-align: center;"><b>Insufficient Flow</b></div>  <div style="background-color: #0056b3; color: white; padding: 5px; text-align: center;">Press RETURN to clear</div>	<p>◀ Error caused by no water flow through heater or no water in heater. Check to be sure there is enough water flow through heater.</p>	<div style="background-color: #0056b3; color: white; padding: 5px; text-align: center;"><b>Sensor 1 short</b></div>  <div style="background-color: #0056b3; color: white; padding: 5px; text-align: center;">Press RETURN to clear</div>
<div style="background-color: #0056b3; color: white; padding: 5px; text-align: center;"><b>Low Flow</b></div>  <div style="background-color: #0056b3; color: white; padding: 5px; text-align: center;">Press RETURN to clear</div>	<p>◀ Check to be sure there is enough water flow through heater.</p>	<div style="background-color: #0056b3; color: white; padding: 5px; text-align: center;"><b>Sensor 2 open</b></div>  <div style="background-color: #0056b3; color: white; padding: 5px; text-align: center;">Press RETURN to clear</div>
<div style="background-color: #0056b3; color: white; padding: 5px; text-align: center;"><b>Water Overheat</b></div>  <div style="background-color: #0056b3; color: white; padding: 5px; text-align: center;">Press RETURN to clear</div>	<p>◀ Wait for water temperature to cool down.</p>	<div style="background-color: #0056b3; color: white; padding: 5px; text-align: center;"><b>Sensor 2 short</b></div>  <div style="background-color: #0056b3; color: white; padding: 5px; text-align: center;">Press RETURN to clear</div>
<div style="background-color: #0056b3; color: white; padding: 5px; text-align: center;"><b>Heater Overheat</b></div>  <div style="background-color: #0056b3; color: white; padding: 5px; text-align: center;">Press RETURN to clear</div>	<p>◀ Wait for water temperature to cool down. Check to be sure there is enough water flow through heater.</p>	<div style="background-color: #0056b3; color: white; padding: 5px; text-align: center;"><b>Sensor 3 open</b></div>  <div style="background-color: #0056b3; color: white; padding: 5px; text-align: center;">Press RETURN to clear</div>
<div style="background-color: #0056b3; color: white; padding: 5px; text-align: center;"><b>Potential Freeze</b></div>  <div style="background-color: #0056b3; color: white; padding: 5px; text-align: center;">Press RETURN to clear</div>	<p>◀ Error caused when SENSOR 1, 2, or 3 detects low temperature. All JETS and BLOWERS will turn on automatically to protect plumbing from freezing. JETS and BLOWERS will shut down when all 3 SENSORS reach a desired temperature.</p>	<div style="background-color: #0056b3; color: white; padding: 5px; text-align: center;"><b>Sensor 3 short</b></div>  <div style="background-color: #0056b3; color: white; padding: 5px; text-align: center;">Press RETURN to clear</div>

# Swim Spa Workout Instructions

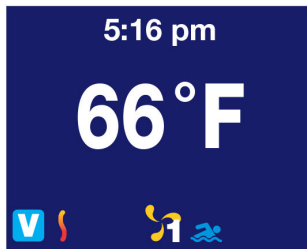

**1.** Press the **SWIM** button to turn the pump **ON** – the blue **SWIM** icon on the LCD screen turns **ON**.

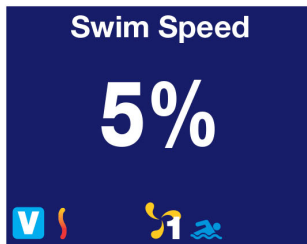

**2.** Then press **UP** or **DOWN** button to select your desired **SPEED %**.

**3.** Press the **SWIM** button again to turn **OFF** the pump – the blue **SWIM** icon on the LCD screen turns **OFF**.



# Swim Workout Programming

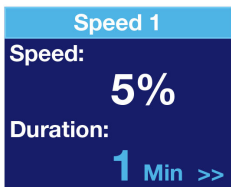
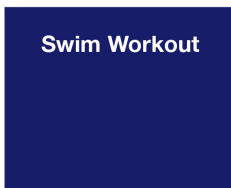
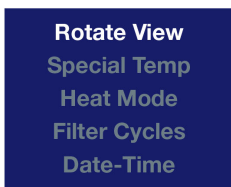

**1.** To program the **SWIM WORKOUT**; press the **MENU** button; then **UP** button and select **SWIM WORKOUT** by pressing the **MENU** button to get to the **SPEED 1** setting.

**2.** Press the **UP** or **DOWN** button to select the **SPEED %** for **SPEED 1**; then press the **MENU** button to select **DURATION** in minutes; then press the **MENU** button twice to get to **SPEED 2**.

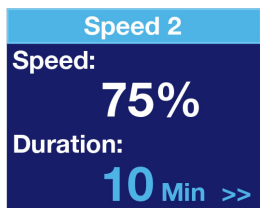
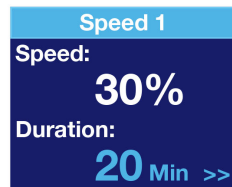
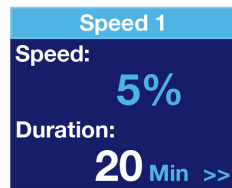
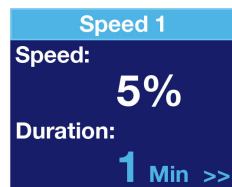

**3.** Press the **UP** or **DOWN** button to select the **SPEED %** for **SPEED 2**; then press the **MENU** button to select **DURATION** in minutes; then press the **MENU** button twice to get to **SPEED 3**.

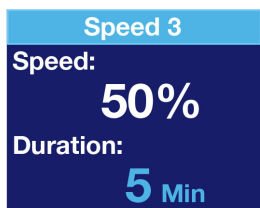

**4.** Press the **UP** or **DOWN** button to select the **SPEED %** for **SPEED 3**; then press the **MENU** button to select **DURATION** in minutes; then press the **MENU** button twice to get out of **SPEED 4**. Repeat this step for up to 10 speed settings.



**5.** Press the **UP** or **DOWN** button to select the **SPEED %** for **SPEED 4**; then press the **MENU** button to select **DURATION** in minutes; then press the **RETURN** button twice to get out of **SWIM WORKOUT** screen.

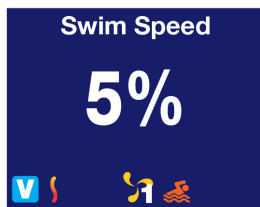

**6.** Press the **SWIM WORKOUT** button to turn **ON** the pump – the red **SWIM** icon on the LCD screen turns **ON**. The **WORKOUT** feature will activate to cycle each of the **SPEED** setting and specific **DURATION** setting for **WORKOUT**. If you need to increase or decrease the pump speed manually; then press the **UP** or **DOWN** button to your desired **SPEED %** in each cycle.

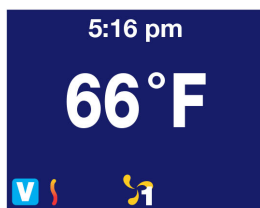

**7.** Press the **SWIM WORKOUT** button again to turn **OFF** the pump – the red **SWIM** icon on the LCD screen turns **OFF**.

## NEO Settings for Cold Climates

It may be necessary to adjust some settings of the NEO Spa controller in cold climates. The guidance below will help to make certain you will continue to enjoy your spa despite the change in season.

### Make certain:

**The cover of the spa is securely fastened to the spa when the spa is not in use.**

- Keeping the cover on the spa will conserve heat and energy.

### The 'ENERGY INTERVAL' is set to 15 minutes:

- Press MENU
- Select 'ENERGY INTERVAL'
- Use WARM/COOL to adjust the interval to 15 minutes.
- Press RETURN to save the setting.

This will make certain the spa checks the temperature of the water every 15 minutes to maintain the Set Temperature.



A video guide can be found here:

<https://www.youtube.com/watch?v=K3I9iOITL-k>

### The system is in 'STANDARD' heat mode:

- Press MENU
- Press WARM/COOL to select 'HEAT MODE'.
- Press MENU to enter 'HEAT MODE'.
- Press WARM/COOL to select 'STANDARD'.
- Press RETURN to save the setting.



**A temperature higher than 104 degrees (F) may be desired on occasion.**

### 'SPECIAL TEMP' can be used for these instances:

- Press MENU
- Press WARM/COOL to select 'SPECIAL TEMP'.
- Press MENU to enter 'SPECIAL TEMP'.
- Press MENU to enter or RETURN to exit.
- Press WARM/COOL to select '105' or '106'.
- Press RETURN to save the setting.

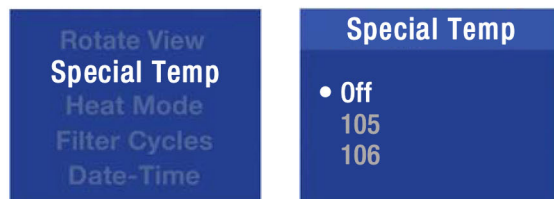

'Special Temp' will heat the spa one time to the selected temperature. The spa will then maintain the previous 'Set Temperature'.

## spaTouch Icon Driven Control Panel



## Changing Languages for the Display

1. Touch the Settings Icon at the lower right portion of the screen.

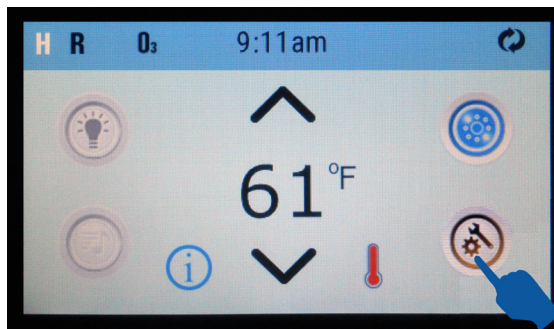

2. Touch the Right Arrow Icon at the lower right portion of the screen. It takes you to the next page.

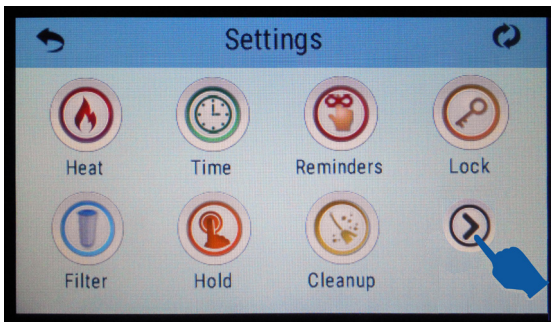

3. Touch the Language Icon.

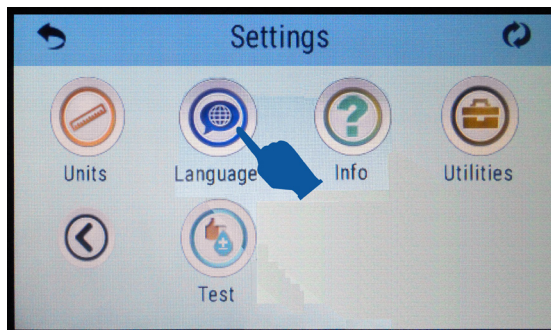

## Language

The Language Icon  on the Settings Screen takes you to the Language screen. Change the language displayed on the panel.

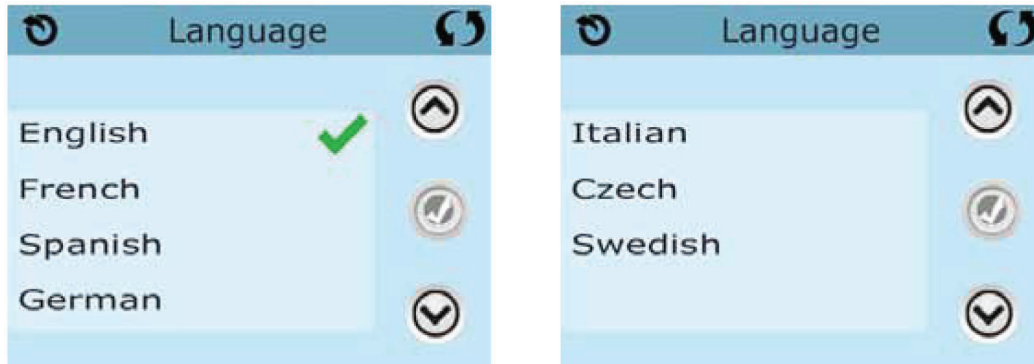

4. As an example, touch the Spanish option as shown below.

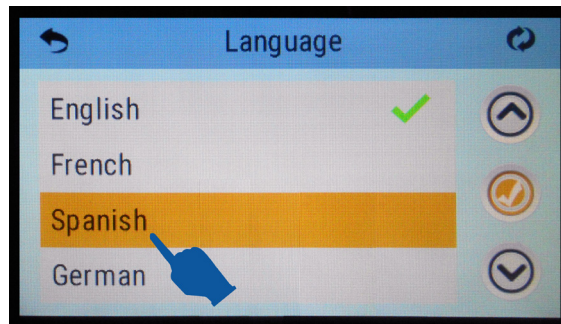

5. Next, touch the Save Icon on the right to confirm this selection.

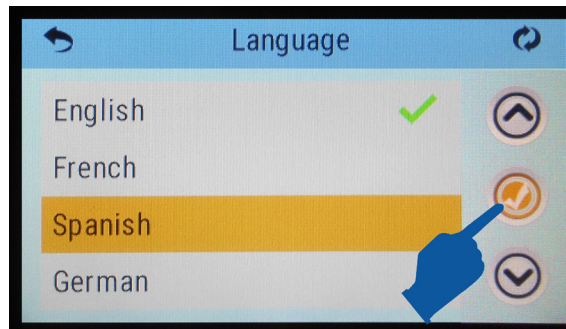

6. ...and now (as an example), the spaTouch screen will be reset to Spanish.

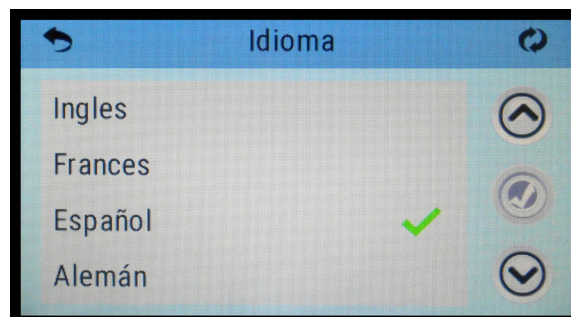

# The Main Screen (Home)

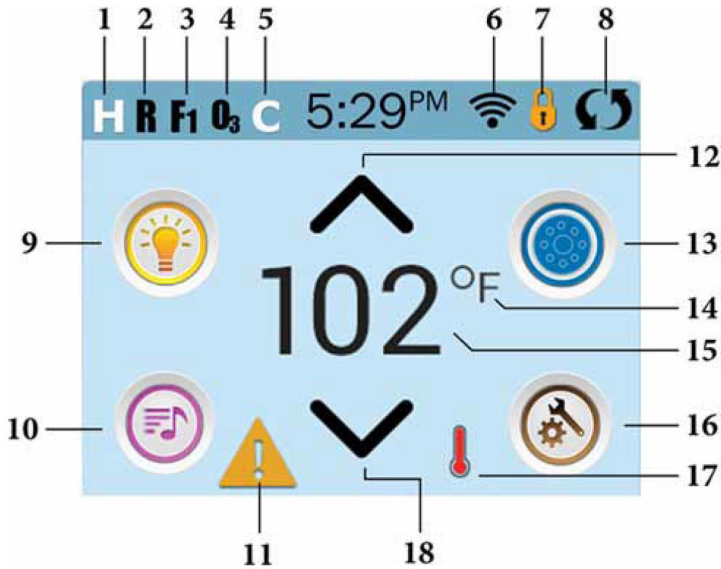

**Note:** After 30 minutes\* the display will automatically go into sleep mode, which turns the display off. This is normal operation. Touch anywhere on the screen to wake the panel up.

### ICON Specifications

- 1. H = High Temperature Range
- 2. R = Ready Mode
- 3. F1 = Filter Cycle 1 Running
- 4. O3 = Ozone Running
- 5. C = Cleanup Cycle
- 6. Wi-Fi Signal Indicator
- 7. Lock Indicator Icon
- 8. Invert Screen
- 9. Light Icon = Turns On/Off
- 10. Music Icon = Press To Enter Music Screen
- 11. Message Waiting Indicator
- 12. Set Temperature Up
- 13. Spa Equipment Control Icon
- 14. Temperature Scale (F/C)
- 15. Current Water Temperature
- 16. Settings Icon
- 17. Heat Indicator
- 18. Set Temperature Down

### Navigation

Navigating the entire menu structure is done by touching the screen.

The three screen selections indicated below can be selected. Touch one of these to enter a different screen with additional controls.

Most menu screens time out and revert to the main screen after 30 seconds of no activity.

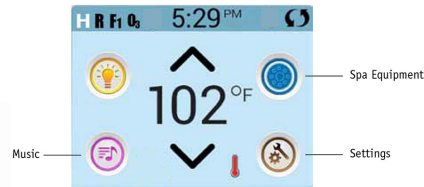

### Messages

At the bottom of the screen, at certain times an indicator may appear showing that a message is waiting. Touch this indicator to go to the Message Display Screen. On that Screen some of the messages can be dismissed.

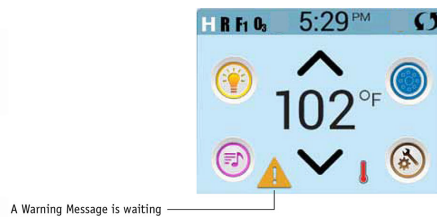

## Set Temperature

Press Up or Down once to display the Set Temperature (indicated by a flashing °F or °C, plus a change in color of the temperature). Press Up or Down again to modify the Set Temperature. The Set Temperature changes immediately.

If you need to switch between High Temperature Range and Low Temperature Range you need to go to the Settings Screen.

### Press-and-Hold

If Up or Down is pressed and held, the temperature will continue to change until you stop pressing, or until the Temperature Range limits are reached.

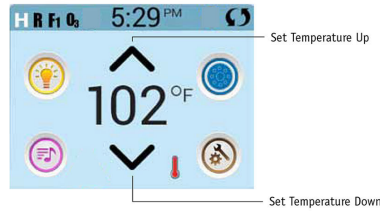

## All Equipment Access

The Spa Screen shows all available equipment\* to control. The display shows icons that are related to the equipment installed on a particular spa model, so this screen may change depending on the installation.

The icon buttons are used to select and control individual devices.

Some devices, like pumps, may have more than one ON state, so the icon will change to reflect the state of the equipment. Below are some examples of 2-speed Pump indicators.



If the Spa has a Circ Pump, a Circ Pump Icon will appear to indicate its activity, but outside of Priming Mode, the Circ Pump cannot be controlled directly.

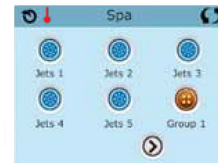

## Values Increment/Decrement

If an Up or Down button is shown and pressed when on an editing page, and a value has been selected (highlighted), the value can be incremented by pressing the up arrow or decremented by pressing the down arrow.

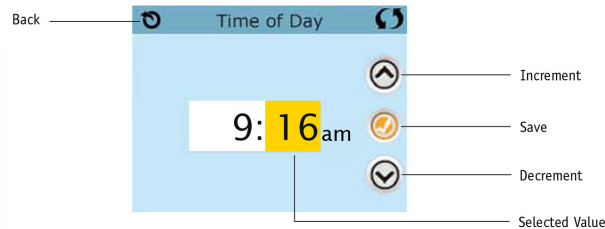

## Invert

Will appear on upper right on all screens.



## Exiting Screens

The Back button is on every screen except the Main Screen, the Priming Mode Screen are a Message Display Screen.

When you see only this button, or this button plus an Inactive Save Button, it means Back or Exit. It appears on editing screens before you have changed any value, as well as on all other screens.

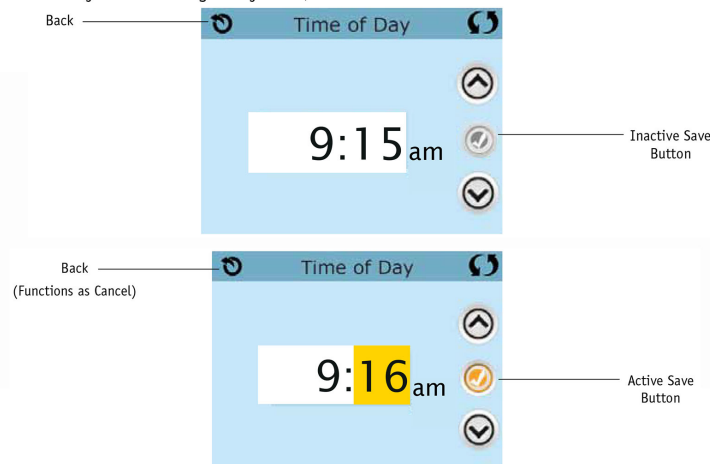

When you see both the Back button and an Active Save button, the Save button will Save, while the Back button will Cancel. If the screen times out due to no activity it will act like Cancel.



**Page Right/Left**

If there is a right arrow at the bottom of the screen, it takes you to the next page.  
If there is a left arrow at the bottom of the screen, it takes you to the previous page.



**Page Up/Down**

If an Up or Down button is shown and pressed when on a page with a text list, the list can be scrolled a page at a time.



**Programming, Etc.**

The Settings Screen is where all programming and other spa behaviors are controlled.  
Each icon on the Settings screen takes you to a different screen, where one or more setting may be viewed and/or edited.



The Heat Icon  takes you to a screen where you control the Heat Mode and the Temperature Range.

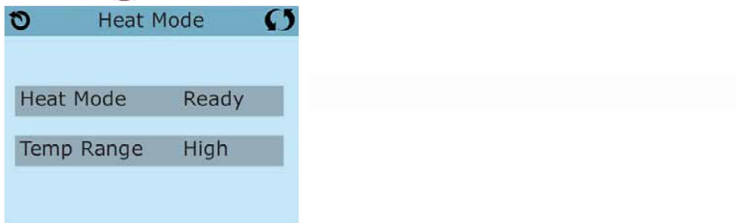

**Dual Temperature Ranges (High vs. Low)**

This system incorporates two temperature range settings with independent set temperatures. The specific range can be selected on the Settings screen and is visible on the Main Screen in the upper left corner of the display.  
These ranges can be used for various reasons, with a common use being a “ready to use” setting vs. a “vacation” setting. Each range maintains its own set temperature as programmed by the user. This way, when a range is chosen, the spa will heat to the set temperature associated with that range.  
*High Range can be set between 80°F and 104°F. More specific Temp Ranges may be determined by the Manufacturer.*  
*Low Range can be set between 50°F and 99°F. Freeze Protection is active in either range.*

**Heat Mode – Ready vs. Rest**

In order for the spa to heat, a pump needs to circulate water through the heater. The pump that performs this function is known as the “heater pump.”

The heater pump can be either a 2-speed pump (Pump 1) or a circulation pump.  
If the heater pump is a 2-Speed Pump 1, Ready Mode will circulate water every 1/2 hour, using Pump 1 Low, in order to maintain a constant water temperature, heat as needed, and refresh the temperature display. This is known as “polling.”  
Rest Mode will only allow heating during programmed filter cycles. Since polling does not occur, the temperature display may not show a current temperature until the heater pump has been running for a minute or two.  
When the heater pump has come on automatically (for example for heating) you can switch between low speed and high speed but you cannot turn the heater pump off.

**Circulation Mode (See Page 13, under Pumps, for other circulation modes)**

If the spa is configured for 24HR circulation, the heater pump generally runs continuously. Since the heater pump is always running, the spa will maintain set temperature and heat as needed in Ready Mode, without polling.  
In Rest Mode, the spa will only heat to set temperature during programmed filter times, even though the water is being filtered constantly when in 24HR circulation mode.

**Ready-in-Rest Mode**

Ready in Rest Mode appears in the display if the spa is in Rest Mode and the Jets 1 Button is pressed. When the heater pump has come on automatically (for example for heating) you can switch between low speed and high speed but you cannot turn the heater pump off. After 1 hour, the System will revert to Rest Mode. This mode can also be reset by selecting the Heat Mode line on the Screen shown here.

## Priming Mode – M019

After the initial start-up sequence, the control will enter Priming Mode and display a Priming Mode screen. Only pump icons appear on the priming mode screen. During the priming mode, the heater is disabled to allow the priming process to be completed without the possibility of energizing the heater under low-flow or no-flow conditions. Nothing comes on automatically, but the pump(s) can be energized by selecting the “Jet” buttons. If the spa has a Circ Pump, it can be turned on and off by pressing the “Circ” button during Priming Mode.

## Exiting Priming Mode

The system will automatically enter the normal heating and filtering at the end of the priming mode, which lasts 4-5 minutes.

— — — — °F      — — — — °C

## Filtration and Ozone

On non-circ systems, Pump 1 low and the ozone generator will run during filtration. On circ systems, the ozone will generally run with the circ pump, but can be limited to filtration cycles. (On some circs systems, Pump 1 low will run along with the circ Pump during filtration.)

The system is factory-programmed with one filter cycle that will run in the evening (assuming the time-of-day is properly set) when energy rates are often lower. The filter time and duration are programmable. A second filter cycle can be enabled as needed.

At the start of each filter cycle, the water devices like blower, mister device (if these exist) and other pumps will run briefly to purge the plumbing to maintain good water quality.

## Freeze Protection

If the temperature sensors within the heater detect a low enough temperature, then the water devices automatically activate to provide freeze protection. The water devices will run either continuously or periodically depending on conditions.

In colder climates, an optional freeze sensor may be added to protect against freeze conditions that may not be sensed by the standard sensors. Auxiliary freeze sensor protection acts similarly except with the temperature thresholds determined by the switch. See your dealer for details.

## Clean-up Cycle (optional)

When a pump or blower is turned on by a button press, a clean-up cycle begins 30 minutes after the pump or blower is turned off or times out. The pump and the ozone generator will run for 30 minutes or more, depending on the system. On some systems, you can change this setting.

## Be sure to set the Time-of-Day

Setting the time-of-day is important for determining filtration times and other background features.

The Heat Icon  on the Settings Screen takes you to a screen where you control the Time-of-Day.

On the Time-of-Day screen, simply select the Hours and Minutes. Use the Up and Down Buttons to make changes, then Save.

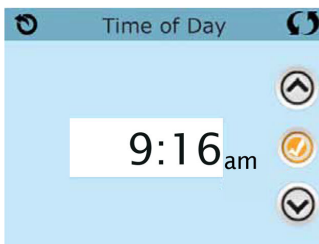

If no time-of-day is set in the memory an Information Screen will appear. If you exit it and Information Icon will appear at the bottom of the Main Screen, until the time-of-day has been set.

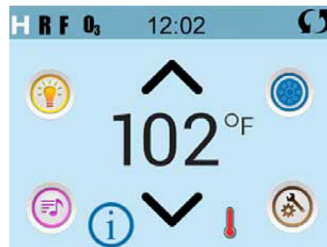

### Note:

This only applies to some systems:  
If power is interrupted to the system,  
Time-of-Day will be maintained for several days.

### Main Filtration

Using the same adjustment as Setting the Time, Filter Cycles are set using a start time and a duration. Each setting can be adjusted in 15-minute increments. The panel calculates the end time and displays it automatically.

The Filter Icon  on the Settings Screen takes you to a screen where you control the Filter Cycles.

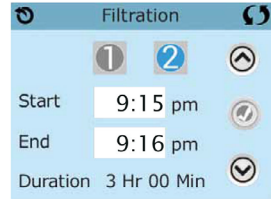

### Filter Cycle 2 - Optional Filtration

Filter Cycle 2 is OFF by default.

Viewing Filter 1 while Filter 2 is OFF:



Viewing Filter 1 while Filter 2 is ON:



Press "1" to view Filter 1. Press "2" once to view Filter 2. Press "2" again to turn Filter 2 ON or OFF.

When Filter Cycle 2 is ON, it can be adjusted in the same manner as Filter Cycle 1.

It is possible to overlap Filter Cycle 1 and Filter Cycle 2, which will shorten overall filtration by the overlap amount.

### Light Cycle Option

If Light Cycle does not appear on the Settings Screen, the Light Timer feature is not enabled by the manufacturer.

The Light Cycle Icon  on the Settings Screen takes you to a screen where you control the Light Cycle.

When available, the Light Timer is ("Disabled") by default. Press "Disabled" to change it to "Enabled" (ON).

The settings can be edited the same way that Filter Cycles are edited.



### Restricting Operation



The control can be restricted to prevent unwanted use or temperature adjustments.

Locking the Panel prevents the controller from being used, but all automatic functions are still active.

Locking the Settings allows Jets and other features to be used, but the Set Temperature and other programmed settings cannot be adjusted.

Settings Lock allows access to a reduced selection of menu items. These include Filter Cycles, Invert, Information and Fault Log. They can be seen, but not changed or edited.

### Locking and Unlocking

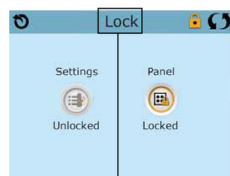

Press here for 5 seconds to lock or unlock.

The same steps are used to Lock and Unlock.

To lock either Settings or Panel first select Settings (if it says "Unlocked") or Panel (if it says "Unlocked"), then press the word "Lock" for at least 5 seconds.

To unlock either Settings or Panel first select Settings (if it says "Locked") or Panel (if it says "Locked"), then press the word "Lock" for at least 5 seconds.

## Hold - M037

Hold Mode is used to disable the pumps during service functions like cleaning or replacing the filter. Hold Mode will last for 1 hour unless the mode is exited manually. If spa service will require more than an hour, it may be best to simply shut down power to the spa.

The Hold Icon  on the Settings Screen places the spa in Hold Mode and displays the System Hold screen. Touch Back to exit Hold Mode.

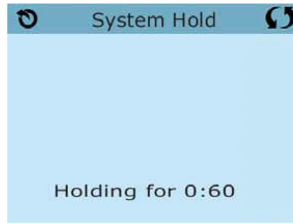

## Drain Mode

Some spas have a special feature that allows Pump 1 to be employed when draining the water. When available, this feature is a component of Hold Mode.

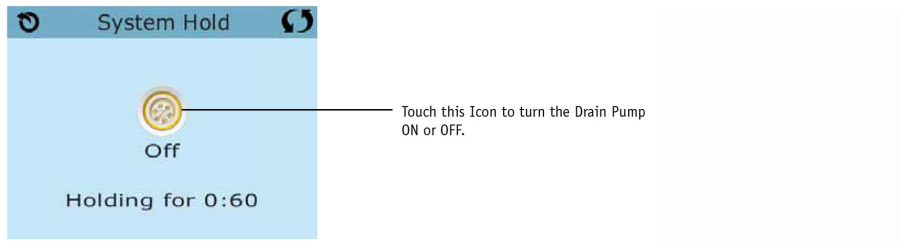

## Utilities

The Utilities Icon  on the Settings Screen takes you to the Utilities Screen.

The Utilities Screen contains the following:

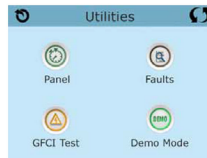

## Panel

Touching the Panel Icon  on the Utilities Screen takes you to the Panel Screen, where you can set how long it takes the panel to go to sleep after the last activity. The Sleep Timer can be set from 1 minute to 60 minutes. The default is 30 minutes.

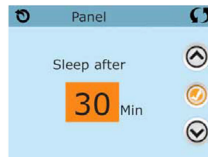

## Demo Mode

Demo Mode is not always enabled, so it may not appear. This is designed to operate several devices in a sequence in order to demonstrate the various features of a particular hot tub.

## Fault Log

The Fault Log is a record of the last 24 faults that can be reviewed by a service tech.

Use the Up and Down buttons to view each of the Faults.

When Priming Mode shows in the Fault Log, it is not a fault. Rather, it is used to keep track of spa restarts.

## Units Screen

The Units Icon  on the Settings Screen takes you to the Units Screen.

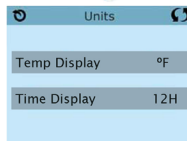

Press "Temp Display" to change the temperature between Fahrenheit and Celsius.  
Press "Time Display" to change the clock between 12 hr and 24 hr display.

## Reminders

The Reminder Icon  on the Settings Screen takes you to the Reminders screen.

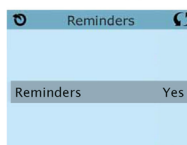

Press "Reminders" to turn the reminder messages (like "Clean Filter") ON (Yes) or OFF (No).

## Cleanup Cycle

Cleanup Cycle Duration is not always enabled, so it may not appear. When it is available, set the length of time Pump 1 will run after each use. 0-4 hours are available. Settings it to 0.0 Hr keeps the Cleanup Cycles from running.

The Cleanup Icon  on the Settings Screen takes you to the Cleanup Cycle screen.

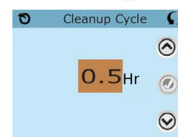

## Language

The Language Icon  on the Settings Screen takes you to the Language screen.

Change the language displayed on the panel.

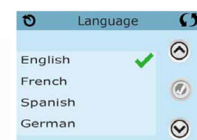

Most messages and alerts will appear at the bottom of the normally used screens. Several alerts and messages may be displayed in a sequence.

---°F ---°C  
**Water Temperature is Unknown**

After the pump has been running for 1 minute, the temperature will be displayed.



**Possible freezing condition**

A potential freeze condition has been detected, or the Aux Freeze Switch has closed. All water devices are activated. In some cases, pumps may turn on and off and the heater may operate during Freeze Protection. This is an operational message, not an error indication.

**The water is too hot – M029**

The system has detected a spa water temp of 110°F (43.3°C) or more, and spa functions are disabled. System will auto reset when the spa water temp is below 108°F (42.2°C). Check for extended pump operation or high ambient temp.

**Heater-Related Messages**

**The water flow is low – M016**

There may not be enough water flow through the heater to carry the heat away from the heating element. Heater start up will begin again after about 1 min. See “Flow Related Checks” below.

**The water flow has failed\* – M017**

There is not enough water flow through the heater to carry the heat away from the heating element and the heater has been disabled. See “Flow Related Checks” below. After the problem has been resolved, reset the message\*.

**The heater may be dry\* – M028**

Possible dry heater, or not enough water in the heater to start it. The spa is shut down for 15 min. Reset this message\* to reset the heater start-up. See “Flow Related Checks” below.

**The heater is dry\* – M027**

There is not enough water in the heater to start it. The spa is shut down. After the problem has been resolved, you must reset the message\* to restart heater start up. See “Flow Related Checks” below.

**The heater is too hot\* – M030**

One of the water temp sensors has detected 118°F (47.8°C) in the heater and the spa is shut down. You must reset the message\* when water is below 108°F (42.2°C). See “Flow Related Checks” below.

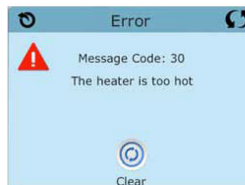

**Flow-Related Checks**

Check for low water level, suction flow restrictions, closed valves, trapped air, too many closed jets and pump prime. On some systems, even when spa is shut down by an error condition, some equipment may occasionally turn on to continue monitoring temperature or if freeze protection is needed.

\* *Some messages can be reset from the panel.* Messages that can be reset will appear with a Clear Icon at the bottom of the Message Screen. Press the Clear Icon text to reset the message.

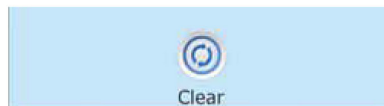

## Sensor-Related Messages

### Sensors are out of sync – M015\*\*

The temperature sensors MAY be out of sync by 3°F. Call for Service if this message does not disappear within a few minutes.

### Sensors are out of sync -- Call for service\* – M026\*\*

The temperature sensors ARE out of sync. The fault above has been established for at least 1 hour. Call for Service.



### Sensor A Fault, Sensor B Fault – Sensor A: M031\*\*, Sensor B: M032\*\*

A temperature sensor or sensor circuit has failed. Call for Service.

## Miscellaneous Messages

### Communications error

The control panel is not receiving communication from the System. Call for Service.

### Test software installed

The Control System is operating with test software. Call for Service.

\* *Some messages can be reset from the panel.* Messages that can be reset will appear with a Clear Icon at the bottom of the Message Screen. Press the Clear Icon text to reset the message.



\*\*MOXX is a Message Code. Codes like this will be seen in the Fault Log

## System-Related Messages

### Program memory failure\* – M022\*\*

At Power-Up, the system has failed the Program Checksum Test. This indicates a problem with the firmware (operation program) and requires a service call.

### The settings have been reset (Persistent Memory Error)\* – M021\*\*

Contact your dealer or service organization if this message appears on more than one power-up.

### The clock has failed\* – M020\*\*

Contact your dealer or service organization.

### Configuration error (Spa will not Start Up)

Contact your dealer or service organization.

### The GFCI test failed (System Could Not Test the GFCI) – M036\*\*

(North America Only) May indicate an unsafe installation. Contact your dealer or service organization.

### A pump may be stuck on – M034\*\*

Water may be overheated. POWER DOWN THE SPA. DO NOT ENTER THE WATER. Contact your dealer or service organization.

### Hot fault – M035\*\*

A Pump Appears to have been Stuck ON when spa was last powered. POWER DOWN THE SPA. DO NOT ENTER THE WATER. Contact your dealer or service organization.

\* *Some messages can be reset from the panel.* Messages that can be reset will appear with a Clear Icon at the bottom of the Message Screen. Press the Clear Icon text to reset the message.



\*\*MOXX is a Message Code. Codes like this will be seen in the Fault Log

## spaTouch™ 3 User Guide



42344\_Rev C

spaTouch™ 3 User Guide 3

# TABLE OF CONTENTS

THE MAIN SCREEN	04
WAKE UP THE PANEL, NAVIGATION & COMMON BUTTONS	06
SET TIME-OF-DAY	09
SET THE TEMPERATURE	10
RUN SPA DEVICES	12
SET FILTER CYCLE TIME	13
RESTRICT OPERATIONS	15
SPA BEHAVIOR	17
DIAGNOSTICS SCREEN	19
HEAT SETTINGS	22
SETTINGS SCREEN	24
FILL IT UP!	26
MESSAGES	27
APPENDIX	30
WARNING	31

# THE MAIN SCREEN

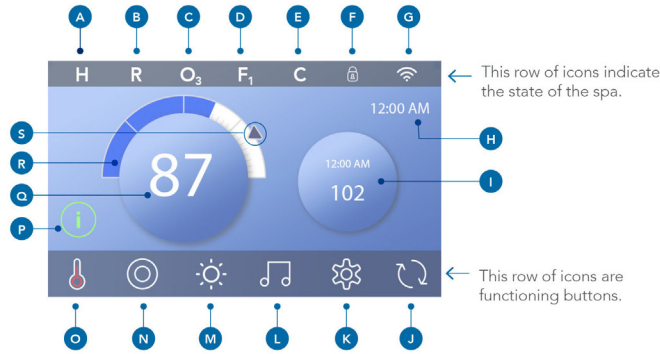

## Main Screen Icons

- A** - Temperature Range  
High: **H**  
Low: **L**
- B** - Heat Mode  
Ready: **R**  
Rest: **☒**  
Ready-in-Rest: **RR**
- C** - Ozone Running: **O<sub>3</sub>**
- D** - Filter Cycles  
Filter Cycle 1: **F<sub>1</sub>**  
Filter Cycle 2: **F<sub>2</sub>** (Optional Feature)  
Filter Cycles 1 & 2: **F+**
- E** - Cleanup Cycle (Optional Feature)
- F** - Panel Locked and/or Settings Locked
- G** - WiFi (Local or Cloud Connection)
- H** - Time-of-Day
- I** - Secondary Button/Display
- J** - Invert Display
- K** - Settings
- L** - bba™ versions 2 and 3 (Balboa Bluetooth Audio)
- M** - Light (or CHROMAZONE™ if installed)  
Both icons change from white to color when these devices are powered On.
- N** - Spa
- O** - Heater Status
- P** - Message Button (May Appear)  
Information: ⓘ  
Reminder: Ⓜ  
Error - Normal Error or Warning: ⚠  
Error - Spa will not function until fixed: ⚠
- Q** - Water Temperature
- R** - Water Temperature Bar
- S** - Set Temperature Arrow

The system configuration determines the number of icons that appear on the Main Screen. Your Main Screen may have fewer or different icons.

## Spa Status

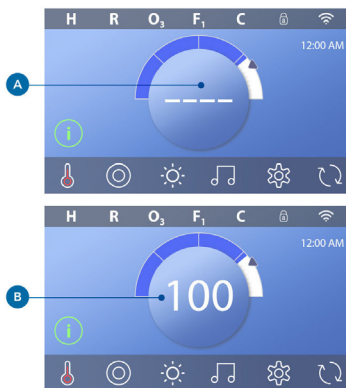

Important information about spa operations can be seen on the Main Screen. Most features, including Set Temperature adjustment, can be accessed from this screen. The actual water temperature can be seen, and the Set Temperature can be adjusted (see page 10). Time-of-Day, Ozone and Filter status are available, along with other messages and alerts. The selected Temperature Range is indicated in the upper left corner. A Lock icon is visible if the Panel and/or Settings are locked. Near the bottom of the screen, at certain times an indicator may appear showing that a message is waiting. Touch this indicator to go to the Message Display Screen. On that Screen some of the messages can be dismissed. For more on the Message Display Screen, see page 27.

When the spa is powered On, four dashes appear (A) in the Water Temperature display for one minute. The dashes indicate that the spa is checking the water temperature. After the pump runs for 1 minute, the dashes disappear and the water temperature is displayed (B). The dashes may reappear after the pump has not run for one hour.



## WAKE UP THE PANEL, NAVIGATION & COMMON BUTTONS

Controlling your spa is easy with the intuitive graphical user interface (GUI). This section describes how to navigate and use the GUI.

### Wake Up the Panel

The screen is blank when it is in sleep mode. When you touch the blank screen, this screen appears (A). Wake up the panel by pressing the hand icon (A) and then swiping in the direction of the arrows.

The panel automatically goes into sleep mode when it is not used for 1 minute. The 1 minute duration can be adjusted (view Panel [☰](#) on page 25).

### Buttons

A variety of button styles provide quick access to functions and settings. The large temperature display is a button (B) that controls the Set Temperature. The whole bottom row of the Main screen contains buttons (C).

### Mini Player Button (Set Temperature/Time)

The Mini Player button gives fast access to the Set Temperature and time (D). Show or hide the Mini Player button by pressing the Heater Status button once (E).

### Mini Player Button (Music)

The Mini Player displays music controls (F), if your spa is equipped with bba™ (Balboa Bluetooth Audio) and it is activated. Hide the Mini Player button by pressing the Heater Status button twice (G). The first press displays the Set Temperature/Time Mini Player button. The second press hides the Mini Player button.



### bba™ button (H)

If bba™ is activated, pressing the bba™ button (H) once displays the Mini Player (F) with music controls. Pressing the bba™ button (H) a second time opens the Music screen (I). If bba™ is activated, a white ring appears around the button, as shown here (I).

If bba™ is not activated, pressing the bba™ button (H) once opens the Music screen (I).

If your spa is equipped with bba™, refer to the bba™ user guide that came with the spa. If a user guide was not included, please contact the spa dealer or spa manufacturer.

### Screen Names

Screen names appear in the top row of the screen. For example, this is the Settings screen (J). Screen names are referenced throughout this user guide.

### Navigation

Navigate screens and/or lists with the following buttons:

- ▲ Up
- ▼ Down
- ◀ Left (K)
- ▶ Right (K)
- ↶ Back (L).

### Swiping & Selecting Items in Lists

Swipe a list (N) to find the setting you want. The list will have an arrow (M) that indicates the current setting. If your desired setting appears but is not aligned with the arrow, tap the desired setting to make it align with the arrow. The temperature list will disappear when you tap anywhere outside of it.

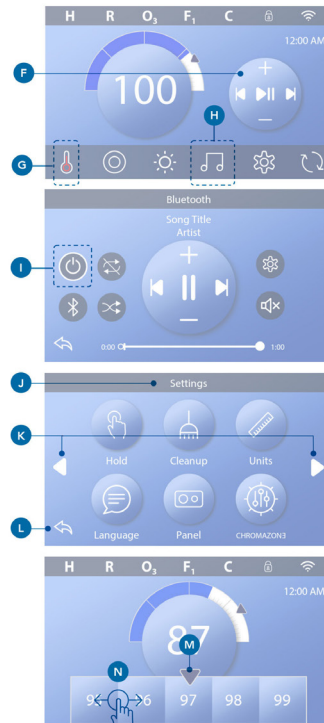

42344\_Rev C

**Saving & Canceling**







After you input a new setting, press the Save button (B). After you press Save, the change is complete. If you don't want to apply a new setting, press the Cancel button (A).

**Message Buttons**

Message buttons provide reminders to help you keep your spa running smoothly. Message buttons also provide warning information that helps spa technicians with troubleshooting.

When a message button appears (C), press it to view the corresponding message (D) or (G). Press the Exit button (E) to go back to the Main screen, or press the Clear button (F) to dismiss the message.

Buttons vary depending on the type of message. View the list below.

-  Information Message
-  Reminder Message
-  Error - Normal Error or Warning
-  Error - Spa will not function until fixed
-  Clear Button
-  Exit Button

spaTouch™ 3 User Guide 8

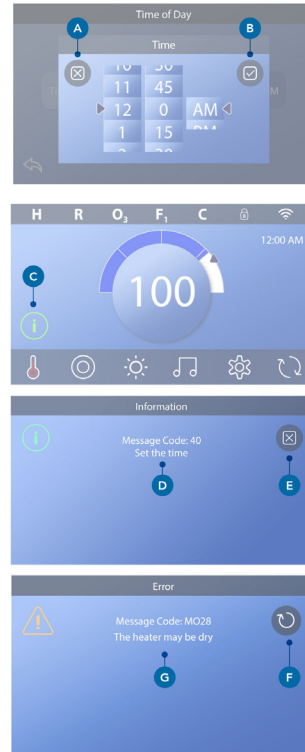

42344\_Rev C

spaTouch™ 3 User Guide 9

## SET THE TIME-OF-DAY

### Be sure to set the Time-of-Day

Follow this sequence to set the time-of-day.

- In the Main screen, press the Settings button (B).
- In the Settings screen, press the Time button (C).
- In the Time of Day screen, press the Time button (D).
- Setting dials appear. Swipe these dials (F) to set the time. If your desired time value appears but is not aligned with the arrow, tap the desired time value to make it align with the arrow.
- Press the Save button (G) to save your settings. Or, press the Cancel button (E) to cancel your settings.

Setting the time-of-day is important for determining filtration times and other background features. If Time-of-Day needs to be set, the Information Message button (A) appears on the Main screen; view the previous page for more information on the different types of Message buttons.

*NOTE: If power is interrupted to the system, Time-of-Day will be maintained for several days (this only applies to some systems).*

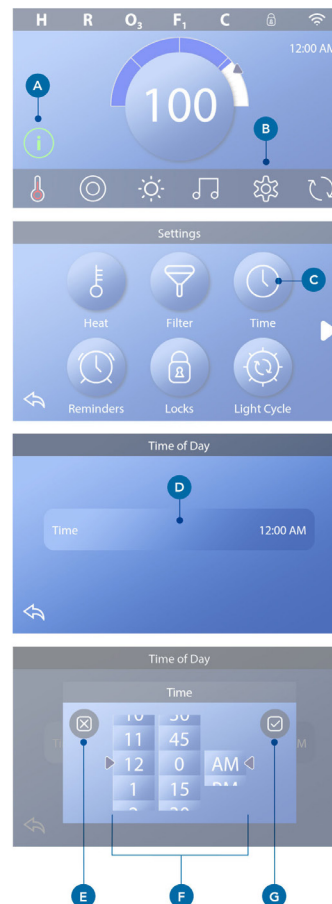

## SET THE TEMPERATURE

In this example we will set the Set Temperature to 102.

- Press the water temperature display button (A) to make the temperature menu appear (B). The center box with the arrow (C) indicates the current Set Temperature.
- If 102 is already showing, but just not centered (D), touch it to center it (E).
- If 102 is not showing (B), swipe the temperature menu until 102 appears (D).
- If 102 appears after swiping but does not stop in the center box (D), press 102. Pressing 102 makes it shift to the center box (E).
- Press the water temperature display button (A) to make the temperature menu disappear. The Set Temperature is now 102.

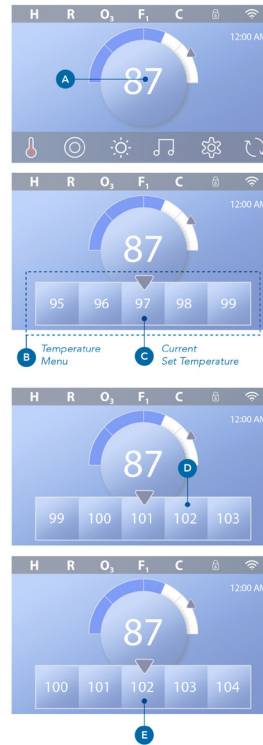

### How do I view the Set Temperature?

Press the Heater Status button (A), and the Set Temperature appears in the Mini Player button (B). Press the Heater Status button again to make the Mini Player button disappear.

Set Temperature is represented numerically and by a blue arrow (D). Water temperature is represented numerically and by a blue status bar (C). The difference between water temperature and Set Temperature is represented by the gap between the blue status bar and the blue arrow (E). If there is no gap, the water temperature and Set Temperature are equal.

### Can I change the Set Temperature with the mini player button?

Yes you can. The mini player button and temperature display button function the same way in this regard. Press the mini player button to view the temperature menu. Select the desired temperature, and press the mini player button again to make the temperature menu disappear. You have now programmed a new Set Temperature.

### How do I know when the heater is On?

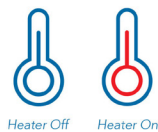

The center of the Heater Status icon (A) turns red (A) when the heater is On. The Heater Status icon appears in the top left corner of the Spa screen (F) when the heater is On.



Note: the Heater Status button icon flashes during heater start-up; this is normal.



## RUN SPA DEVICES

Press the Spa button  (A) to view the Spa screen. Press these buttons (B) to run spa devices. Some devices may only turn On and Off, while other devices may have multiple speeds/states. Your spa configuration determines the number of buttons and the function of the buttons in the Spa screen. One Spa screen displays six buttons, maximum. If more than six buttons exists, a navigation button appears (D). Press the navigation button (D), or swipe, to view the next Spa screen. Press the Back button  (C) to navigate to the Main screen.

If the Jets are left running, they will turn off after a time-out period.

If the Spa has a circulation pump, a circulation pump icon will appear in the Spa screen to indicate its activity only (the icon is not a functioning button). The circulation pump can be controlled with a button during Priming mode (view page 26).

If the spa does not have a circulation pump, then Jets 1 may turn On automatically at times. In these cases, pressing the Jets 1 button will just change speeds, but will not turn Off Jets 1.



### Spa Button





## SET FILTER CYCLE TIME

### Keep your water clean and ready to enjoy

- Follow these steps to set the time for Filter Cycle 1.
- Press the Settings button (A) on the Main screen.
  - Press the Filter button (B) on the Settings screen.
  - Press the Start button (E) on the Filter Cycles screen.
  - Set the Start Time with these dials (J) on the F1 End screen.
  - Press the Save button (K) to save your settings, or press the Cancel button (I) to cancel your settings.
  - Press the End button (F) on the Filter Cycles screen, and follow the same steps to set the End Time.
  - Once the Start and End Times are set, press the Save button (G) on the Filter Cycles screen.
  - Once Start and End Times are set, the Duration appears here (H). You have now set the time for Filter Cycle 1. The white ring (C) indicates that Filter Cycle 1 is enabled (it is always enabled).

Follow the same steps noted above to set the time for Filter Cycle 2.

#### How can you tell if Filter Cycle 2 is enabled?

Filter Cycle 2 is enabled when a white ring appears around the  button. For example, Filter Cycle 1 is enabled (C) in this screen, and Filter Cycle 2 is disabled (D). Press the  button to enable/disable Filter Cycle 2. A Filter Cycle 2 will only run if it is enabled.

*Note: It is possible to overlap Filter Cycle 1 and Filter Cycle 2, which will shorten overall filtration by the overlap amount.*

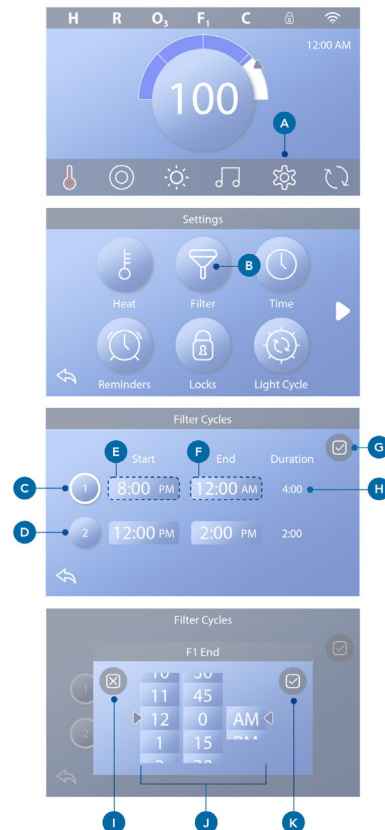

## Adjusting Filtration

### Circulation Pump Modes

Some spas may be manufactured with Circ Pump settings that allow programming filtration cycle duration. Some Circ Modes are pre-programmed to operate 24 hours a day and are not programmable. Refer to the spa manufacturer's documentation for any Circulation Pump Mode details.

### Purge Cycles

In order to maintain sanitary conditions, as well as protect against freezing, secondary water devices will purge water from their respective plumbing by running briefly at the beginning of each filter cycle. (Some systems will run a certain number of purge cycles per day, independent of the number of filter cycles per day. In this case, the purge cycles may not coincide with the start of the filter cycle). If the Filter Cycle 1 duration is set for 24 hours, enabling Filter Cycle 2 will initiate a purge when Filter Cycle 2 is programmed to begin.

### The Meaning of Filter Cycles

1. The heating pump always runs during the filter cycle\*
2. In Rest Mode, heating only occurs during the filter cycle
3. Purges happen at the start of each filter cycle (on most systems).

\* For example, if your spa is set up for 24/hour circulation except for shutting off when the water temperature is 3°F/1.3°C above the set temperature, that shutoff does not occur during filter cycles.

## Additional Settings

### Auxiliary Panel(s)

#### Specific Buttons for Specific Devices

If the spa has an Auxiliary Panel(s) installed, pressing buttons on that panel will activate the device indicated for that button. These dedicated buttons will operate just like the Spa Screen buttons (see page 12) and the equipment will behave in the same manner with each button press.



## RESTRICT OPERATIONS

The following examples show how to lock and unlock the Panel.

### LOCK PANEL

- Press the Settings button (A) on the Main screen.
- Press the Locks button (B) on the Settings screen.
- Press the Panel button (C) on the Locks screen. "Lock Panel" will appear at the top of the screen (D).
- Press-&-hold "Lock Panel" (D) for five seconds. After five seconds a Lock icon (E) will appear in the top row of the Main screen. The lock icon also appears in the top row of the Locks screen. The panel is now locked.

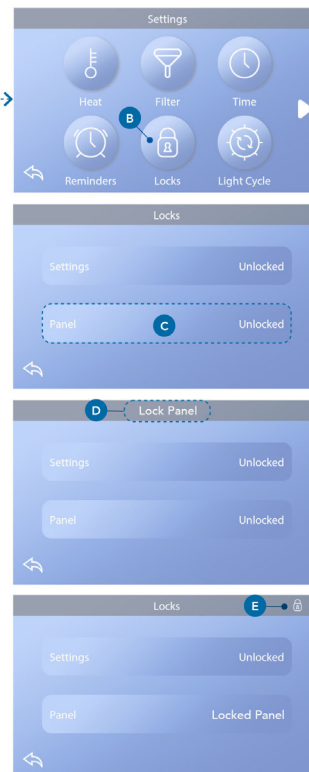
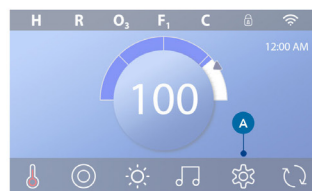

(Continued on next page.)

42344\_Rev C

**UNLOCK PANEL**

- Press the Panel button (F) in the Locks screen, and "Unlock Panel" will appear at the top of the screen (G).
- Press-&-hold "Unlock Panel" (G) for five seconds. After five seconds the Lock icon (I) will disappear from the top row (I) of the Locks screen. The panel is now Unlocked.

The control can be restricted to prevent unwanted use or temperature adjustments. Locking the Panel prevents the controller from being used, but all automatic functions are still active.

**LOCK & UNLOCK SETTINGS**

Follow the same steps noted above to lock and unlock Settings.

Locking the Settings allows Jets and other features to be used, but the Set Temperature and other programmed settings cannot be adjusted. Settings Lock allows access to a reduced selection of menu items. These include Filter Cycles (view only), Invert, Information and Fault Log. They can be seen, but not changed or edited.

**Can Settings and Panel be locked simultaneously?**

Yes. The lock icon (K) appears if Settings or Panel or both are locked. The current lock states are noted on the right side of the buttons (H).

spaTouch™ 3 User Guide 16

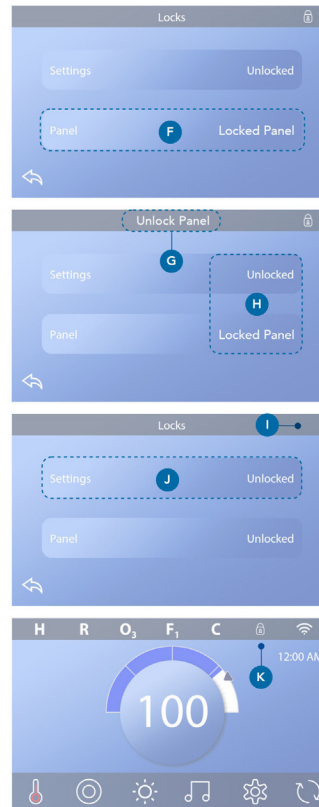

42344\_Rev C

spaTouch™ 3 User Guide 17

# SPA BEHAVIOR

**Pumps**

Pumps drive water and air through the jets. A pump typically has one or two speeds. If left running, a pump will turn off after a time-out period.

**Circulation Pump**

A circulation pump is usually smaller, quieter, and requires less energy than a pump used for jets. A circulation pump typically has one speed and circulates water through the spa's filtration system to keep the water clean. The circulation pump also runs when the blower or any other pump is on.

**Non-Circulation Pump Systems  
(or "non-circ systems")**

If a spa does not have a circulation pump, another pump will function in its place. The low-speed of pump 1 runs when the blower or any other pump is on. If the spa is in Ready Mode (See page 22), Pump 1 low may also activate for at least 1 minute at various intervals to detect the spa temperature (polling) and then to heat to the set temperature if needed. When the low-speed turns on automatically, it cannot be deactivated from the panel, however the high speed may be started.

### Circulation Pump Modes

If the system is equipped with a circulation pump, it will be configured to work in one of three different ways:

1. The circulation pump operates continuously (24 hours) with the exception of turning off for 30 minutes at a time when the water temperature reaches 3°F (1.5°C) above the set temperature (most likely to happen in very hot climates).
2. The circulation pump stays on continuously, regardless of water temperature.
3. A programmable circulation pump will come on when the system is checking temperature (polling), during filter cycles, during freeze conditions, or when another pump is on.

The specific Circulation Mode that is used has been determined by the Manufacturer and cannot be changed in the field.

### Filtration and Ozone

If a spa does not have a circulation pump, Pump 1 low and the ozone generator will run during filtration. On circ systems, the ozone will generally run with the circulation pump, but can be limited to filtration cycles. (On some circ systems, Pump 1 low will run along with the circulation pump during filtration.)

Most systems are factory-programmed with one filter cycle that will run in the evening (assuming the time-of-day is properly set) when energy rates are often lower. The filter time and duration are programmable. A second filter cycle can be enabled as needed. At the start of each filter cycle, the water devices like blower, mister device (if these exist) and other pumps will run briefly to purge the plumbing to maintain good water quality.

### Freeze Protection

If the temperature sensors within the heater detect a low enough temperature, then the water devices automatically activate to provide freeze protection.

The water devices will run either continuously or periodically depending on conditions. In colder climates, an optional freeze sensor may be added to protect against freeze conditions that may not be sensed by the standard sensors. Auxiliary freeze sensor protection acts similarly except with the temperature thresholds determined by the switch. See your dealer for details.



### Clean-up Cycle (optional)

When a pump or blower is turned on by a button press, a clean-up cycle begins 30 minutes after the pump or blower is turned off or times out. The pump and the ozone generator will run for 30 minutes or more, depending on the system. On some systems, you can change this setting.

Clean-up cycles allow the spa to filter less when the spa is used less often, and to filter more when the spa is used more often.

## DIAGNOSTICS SCREEN

The Diagnostics screen is helpful for spa technicians.

Here is how to navigate to the Diagnostics screen starting from the Main screen. Pressing the Settings button  and then the Diagnostics button .

### Info

Info (A) displays various settings and identifications of this system.

### System Model

Displays the Model Number of the System.

### Panel Version

Displays a number of the software in the topside control panel(D).

### Software ID (SSID)

Displays the software ID number for the System.

### Configuration Signature

Displays the checksum for the system configuration file.

### Current Setup

Displays the currently selected Configuration Setup Number.

### Dip Switch Settings

Displays a number that represents the DIP switch positions of S1 on the main circuit board.

### Heater Type

Displays a heater type ID number, or "Standard".

### Heater Voltage (North American system / UL)

North American/UL control systems display operating voltage configured for the heater.

### Heater Wattage (International System / CE)

International/CE control systems display the heater wattage range that is configured for the control system.

### Faults

Faults (B) is a record of the last 24 faults that can be reviewed by a service tech. Use the arrow buttons to view each entry in the Fault Log. When Priming Mode shows in the Fault Log, it is not a fault. Rather, it is used to keep track of spa restarts.



## GFCI Test

(North America Only. Feature not available on CE rated systems.)

Your systems may have GFCI configured in one of three ways:

1. GFCI test is not enabled
2. Manual GFCI test is enabled but automatic GFCI test is not enabled
3. Both manual and automatic GFCI tests are enabled.

The automatic test will happen within 7 days of the spa being installed and if successful will not repeat. (If the automatic test fails it will repeat after the spa is restarted.)

The GFCI Test button (C) will appear on the Diagnostics screen only if the GFCI is enabled.

The GFCI Test screen (view next page) allows the GFCI to be tested manually from the panel and can be used to reset the automatic test feature.

The Ground Fault Circuit Interrupter (GFCI) or Residual Current Detector (RCD) is an important safety device and is required equipment on a hot tub installation. (The GFCI Test Feature is not available on CE rated systems).

### Used for verifying a proper installation

Your spa may be equipped with a GFCI Test feature. If your spa has this feature enabled by the manufacturer, the GFCI Trip Test must occur to allow proper spa function. On some systems:

Within 1 to 7 days after startup, the spa will trip the GFCI to test it. (The number of days is factory programmed.) The GFCI must be reset once it has tripped. After passing the GFCI Trip Test, any subsequent GFCI trips will indicate a ground fault or other unsafe condition and the power to the spa must

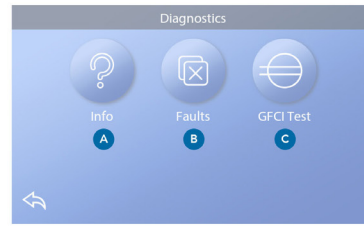

be shut off until a service person can correct the problem.

On systems that do not have the automatic GFCI test, the manual GFCI test must be done.

### Forcing a manual GFCI Trip Test

The installer can cause the GFCI Trip Test to occur at any time by pressing Test on the GFCI Test screen. The GFCI should trip within several seconds and the spa should shut down. If it does not, shut down the power and manually verify that a GFCI breaker is installed and that the circuit and spa are wired correctly. Verify the function of the GFCI with its own test button. Restore power to the spa and repeat the GFCI Trip Test. Once the GFCI is tripped by the test, reset the GFCI and the spa will operate normally from that point. You can verify a successful test by navigating to the above screen. "Passed" should appear on the GFCI screen.

## Warning:

On those systems that automatically test the GFCI within 1 to 7 days after startup:

The end-user must be trained to expect this one-time test to occur. The end-user must be trained how to properly reset the GFCI. If freezing conditions exist, the GFCI or RCD should be reset immediately or spa damage could result.

## GFCI Test (Continued)

### Perform a GFCI Test

Start at the Main screen and follow these steps to manually test the GFCI.

- Press the Settings button  on the Main screen.
- Press the Diagnostics button  on the Settings screen.
- Press the GFCI Test button (C) on the Diagnostics screen. The GFCI Test screen will appear.

If the GFCI Test status is "Passed" (F), you may not need to perform this test.

If the GFCI Test status is "Armed" (D), proceed to the next step.

- Press the Test button (E).

Within approximately 12 seconds, one of the following two things will happen:

- 1 - The spa powers down. After the spa powers down, go to the GFCI and power up the spa. The spa goes into Priming Mode when it is powered up. When Priming Mode is complete, navigate to the GFCI Test screen and confirm that it says "GFCI Status - Passed" (F).
- 2 - A "GFCI Test Failed" message appears. In this case, contact a qualified service technician. While you wait for the spa technician to arrive, the spa can be run normally for a time by cycling the power.

### Reset Button:

Only use the Reset Button prior to moving the spa to a new location. Pressing the Reset button forces a new Test to be performed at the new location.





### CE Product

CE registered systems do not have an RCD Test Feature due to the nature of the electrical service. The end-user must be trained how to properly test and reset the RCD.



# HEAT SETTINGS

## Ready to enjoy!

Make sure your spa is heated and ready to enjoy with Heat Settings. Navigate to the Heat Settings screen from the Main screen by pressing the Settings button . Press the Heat button , and the Heat Settings screen appears (A). The Heat Setting screen does not have Save or Cancel buttons, so changes you make take effect immediately.

## Heat Mode (B)

### Ready **R**

Ready Mode (B) keeps the water temperature within 1° F (0.5° C) of the Set temperature. For example, if the set temperature is 102° F (39.0° C), the water temperature will be within +/- 1° F (0.5° C) of 102° (39.0° C). Press the Heat Mode button (B) to switch between Ready and Rest Mode. The **R** icon appears on the Main screen when the spa is in Ready Mode.

### Rest **R**

Rest Mode functions the same as Ready Mode, except Rest Mode only heats the water during filter cycles (view page 13). Press the Heat Mode button (B) to switch between Ready and Rest Mode. The **R** icon appears on the Main screen when the spa is in Rest Mode.

### Ready-in-Rest **RR**

Ready-in-Rest Mode is the same as Rest Mode, except Ready-in-Rest Mode heats the water, if necessary, for one hour when you turn On Jets 1. The **RR** icon

appears on the Main screen when the spa is in Rest-in-Rest Mode.

If the spa is in Ready-in-Rest mode and you go to the Heat Settings screen (A), that cancels Ready-in-Rest Mode and puts you back into Rest Mode, even if you press no buttons while on the Heat Settings screen.

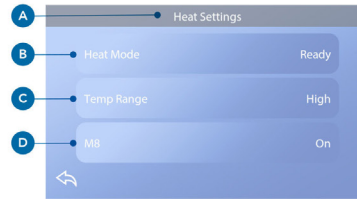

### Heater Pump

In order for the spa to heat, a pump needs to circulate water through the heater. The pump that performs this function is known as the "heater pump".

The heater pump can be either a 2-speed pump (Pump 1) or a circulation pump. If the heater pump is a 2-Speed Pump 1, Ready Mode will circulate water at various intervals, using Pump 1 Low, in order to maintain a constant water temperature, heat as needed, and refresh the temperature display. This is known as "polling."

Rest Mode will only allow heating during programmed filter cycles. Since polling does not occur, the temperature display may not show a current temperature until the heater pump has been running for a minute or two. When the heater pump has come on automatically (for example for heating) you can switch between low speed and high speed but you cannot turn the heater pump off.

## Temp Range (C)

There are two Temp Range settings: High and Low.

### High **H**

The water temperature can be set between 80° - 104° F (26.6° - 40.0° C) when Temp Range is set to High. Press the Temp Range button (C) to switch between High and Low Range. The **H** icon appears in the top row of the Main screen when the spa is in High Range.

### Low **L**

The water temperature can be set between 50° - 99° F (10.0° - 37.2° C) when Temp Range is set to Low. Press the Temp Range button (C) to switch between High and Low Range. The **L** icon appears in the top row of the Main screen when the spa is in Low Range.

*Different High and Low Temp Ranges may be determined by the Manufacturer.*

*Freeze Protection is active in High and Low range.*

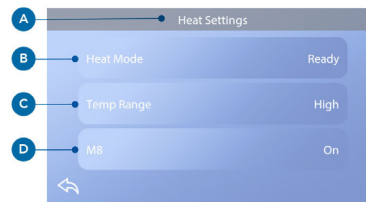

## M8

Press the M8 button (D) to turn it On/Off. The M8 feature looks for opportunities to decrease pump usage, which may increase pump life and save energy. M8 is On by default. M8 is an optional feature and may not appear on all systems.



## SETTINGS SCREEN

Fine tune your spa with a wide variety of Settings.

Starting from the Main screen, press the Settings button  to view the Settings screen (A). Press the navigation arrows   or swipe to view all of the Settings screens.

### Heat

Make sure your spa is heated and ready to enjoy with Heat Settings. (view page 22).

### Filter

Keep your spa water clean and ready to enjoy by setting Filter Cycles (view page 13).

### Time

Set the Time to ensure scheduled features have proper timing (view page 9).

### Reminders

Reminders (A) are helpful spa maintenance messages that display periodically.

### Locks

Lock the Panel and/or Setting (view page 15).

### Light Cycle (Optional)

If you want the spa lights to turn On and Off at a specific time, use Light Cycle (A).

### Hold

Hold (B) is used to disable the pumps during service functions like cleaning or replacing the filter. Hold Mode will last for 1 hour unless the mode is exited manually. If spa service will require more than an hour, it may be best to simply shut down power to the spa. The Hold Icon on the Settings Screen places the spa in Hold Mode and displays the System Hold screen. Touch Back to exit Hold Mode.

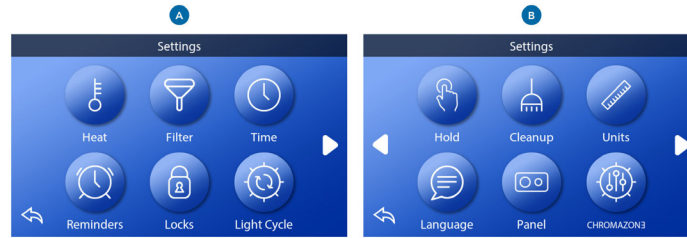

### Hold (continued)

#### Drain Mode (Optional)

Some spas have a special feature that allows Pump 1 to be employed when draining the water. When available, this feature is a component of Hold.

### Cleanup

When a pump or blower is turned on by a button press, a clean-up cycle begins 30 minutes after the pump or blower is turned off or times out. The pump and the ozone generator will run for 30 minutes or more, depending on the system. On some systems, you can change this setting.

### Units

Specify Time and Temperature Units (B). The temperature choices are Fahrenheit or Celsius. The time display choices are 12 hour or 24 hour.

### Language

Select from a variety of languages.

### Panel

Set how long it takes the panel to go to sleep after the last activity. The default is 1 minute. The shortest time (1 minute) is recommended because it decreases the chance of water activating buttons.

### CHROMAZONE™ (Optional)

If your spa is equipped with CHROMAZONE™, refer to the CHROMAZONE™ user guide that came with the spa. If a user guide was not included, please contact the spa dealer or manufacturer.

### Diagnostics

Spa technicians can find useful information and features in Diagnostics (C) (view page 19).

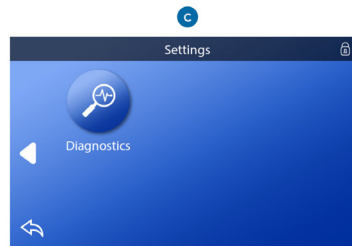

## FILL IT UP!

Follow these steps to prepare your spa.

### Preparation & Filling

Fill the spa to its correct operating level. Be sure to open all valves and jets in the plumbing system before filling to allow as much air as possible to escape from the plumbing and the control system during the filling process. After turning the power on at the main power panel, the top-side panel will display a splash screen or startup screen.

### Priming Mode – M019\*

After the initial start-up sequence, the control will enter Priming Mode and display a Priming Mode screen.

Only pump icons appear on the priming mode screen. During the priming mode, the heater is disabled to allow the priming process to be completed without the possibility of energizing the heater under low-flow or no-flow conditions. Nothing comes on automatically, but the pump(s) can be energized by selecting the "Jet" buttons. If the spa has a Circ Pump, it can be turned on and off by pressing the "Circ" button during Priming Mode.

### Priming the Pumps

As soon as the Priming Mode screen appears on the panel, select the "Jets 1" button once to start Pump 1 in low-speed and then again to switch to high-speed. Also, select the other pumps, to turn them on. The pumps should be running in high-speed to facilitate

priming. If the pumps have not primed after 2 minutes, and water is not flowing from the jets in the spa, do not allow the pumps to continue to run. Turn off the pumps and repeat the process. Note: Turning the power off and back on again will initiate a new pump priming session. Sometimes momentarily turning the pump off and on will help it to prime. Do not do this more than 5 times. If the pump(s) will not prime, shut off the power to the spa and call for service. Important: A pump should not be allowed to run without priming for more than 2 minutes. Under NO circumstances should a pump be allowed to run without priming beyond the end of the 4 minute priming mode. Doing so may cause damage to the pump and cause the system to energize the heater and go into an overheat condition.

### Exiting Priming Mode

The system will automatically enter the normal heating and filtering at the end of the priming mode, which lasts 4 minutes. You can manually exit Priming Mode by pressing the "Back" button on the Priming Mode Screen. Note that if you do not manually exit the priming mode as described above, the priming mode will be automatically terminated after 4 minutes. Be sure that the pump(s) have been primed by this time. Once the system has exited Priming Mode, the top-side panel will display the Main Screen, but the display will not show the water temperature yet. This is because the system requires approximately 1 minute of water flowing through the heater to determine the water temperature and display it.

\*M0XX is a Message Code.

## MESSAGES

### General Messages

Several alerts and messages may be displayed in a sequence.

#### Possible freezing condition

A potential freeze condition has been detected, or the Aux Freeze Switch has closed. All water devices are activated. In some cases, pumps may turn on and off and the heater may operate during Freeze Protection. This is an operational message, not an error indication.

#### The water is too hot – M029\*

The system has detected a spa water temp of 110°F (about 43°C) or more, and spa functions are disabled. System will auto reset when the spa water temp is below 108°F (about 42°C). Check for extended pump operation or high ambient temp.

#### The water level is too low

This message can only appear on a system that uses a water level sensor. It appears whenever the water level get too low (or the water level sensor is disconnected), and automatically disappears when the water level is adequate. Pumps and the heater turn OFF when this message appears.

### Heater-Related Messages

#### The water flow is low – M016\*\*

There may not be enough water flow through the heater to carry the heat away from the heating element. Heater start up will begin again after about 1 minute. See "Flow Related Checks" below.

#### The water flow has failed\* – M017\*\*

There is not enough water flow through the heater to carry the heat away from the heating element and the heater has been disabled. See "Flow Related Checks" below. After the problem has been resolved, reset the message\*.

#### The heater may be dry\* – M028\*\*

Possible dry heater, or not enough water in the heater to start it. The spa is shut down for 15 minutes. Reset this message\* to reset the heater start-up. See "Flow Related Checks" below.

#### The heater is dry\* – M027\*\*

There is not enough water in the heater to start it. The spa is shut down. After the problem has been resolved, you must reset the message\* to restart heater start up. See "Flow Related Checks" below.

#### The heater is too hot\* – M030\*\*

One of the water temp sensors has detected 118°F (about 48°C) in the heater and the spa is shut down. You must reset the message\* when water is below 108°F (about 42°C). See "Flow Related Checks" below.

#### Flow-related checks

Check for low water level, suction flow restrictions, closed valves, trapped air, too many closed jets and pump prime. On some systems, even when spa is shut down by an error condition, some equipment may occasionally turn on to continue monitoring temperature or if freeze protection is needed.

## Sensor-Related Messages

### Sensors are out of sync – M015\*\*

The temperature sensors may be out of sync by 3°F. Call for Service if this message does not disappear within a few minutes.

### Sensors are out of sync -- Call for service\* – M026\*\*

The temperature sensors ARE out of sync. The fault above has been established for at least 1 hour. Call for Service.

### Sensor A Fault, Sensor B Fault – Sensor A: M031\*\*, Sensor B: M032\*\*

A temperature sensor or sensor circuit has failed. Call for Service.

## System-Related Messages

### Program memory failure\* – M022\*\*

At Power-Up, the system has failed the Program Checksum Test. This indicates a problem with the firmware (operation program) and requires a service call.

### The settings have been reset (Persistent Memory Error)\* – M021\*\*

Contact your dealer or service organization if this message appears on more than one power-up.

### The clock has failed\* – M020\*\*

Contact your dealer or service organization.

### Configuration error

The spa will not Start Up. Contact your dealer or service organization.

### The GFCI test failed (System Could Not Test the GFCI) – M036\*\*

(North America Only) May indicate an unsafe installation. Contact your dealer or service organization.

### A pump may be stuck on – M034\*\*

Water may be overheated. POWER DOWN THE SPA. DO NOT ENTER THE WATER. Contact your dealer or service organization.

### Hot fault – M035\*\*

A Pump Appears to have been Stuck ON when spa was last powered. POWER DOWN THE SPA. DO NOT ENTER THE WATER. Contact your dealer or service organization.

## Reminder Messages

Reminder messages can be reset from the panel. Press the Clear Icon to reset the Reminder message.

### General maintenance help

Reminder Messages can be suppressed by using the Reminders Screen. Reminder Messages can be chosen individually by the Manufacturer. They may be disabled entirely, or there may be a limited number of reminders on a specific model. The frequency of each reminder (i.e., 7 days) can be specified by the Manufacturer.

### Check the pH

May appear on a regular schedule, i.e., every 7 days. Check pH with a test kit and adjust pH with the appropriate chemicals.

### Check the sanitizer

May appear on a regular schedule, i.e., every 7 days. Check sanitizer level and other water chemistry with a test kit and adjust with the appropriate chemicals.

### Check ozone

May appear on a regular schedule. Change the UV as instructed by the manufacturer.

## Reminder Messages (Continued)

### Service check-up

May appear on a regular schedule. Do a service check-up as instructed by the manufacturer.

Additional messages may appear on specific systems.

### Clean the filter

May appear on a regular schedule, i.e., every 30 days. Clean the filter media as instructed by the manufacturer.

### Test the GFCI (or RCD)

May appear on a regular schedule, i.e., every 30 days. The GFCI or RCD is an important safety device and must be tested on a regular basis to verify its reliability. Every user should be trained to safely test the GFCI or RCD associated with the hot tub installation. A GFCI or RCD will have a TEST and RESET button on it that allows a user to verify proper function.

### Change the water

May appear on a regular schedule, i.e., every 90 days. Change the water in the spa on regular basis to maintain proper chemical balance and sanitary conditions.

### Clean the cover

May appear on a regular schedule, i.e., every 180 days. Vinyl covers should be cleaned and conditioned for maximum life.

### Treat the wood

May appear on a regular schedule, i.e., every 180 days. Wood skirting and furniture should be cleaned and conditioned per the manufacturers instructions for maximum life.

### Change the filter

May appear on a regular schedule, i.e., every 365 days.

Filters should be replaced occasionally to maintain proper spa function and sanitary conditions.

### Change the UV

May appear on a regular schedule. Change the UV as instructed by the manufacturer.

## Miscellaneous Messages

### Set the Time-of-Day

When a control system that displays this message is powered On, its time-of-day is initialized to 12:00 PM. Setting the proper time-of-day is important for determining filtration times and other background features (view page 9).

### Communications error

The control panel is not receiving communication from the System. This can appear briefly during system start-ups. This is normal. If it does not go away quickly, Call for Service.

### Test software installed

The Control System is operating with test software. Call for Service.

## Message Notes

Some messages include the "Call for Service" text as it requires a service technician to fix the problem.

If the panel is locked and a message alert appears, you will be taken to the Lock Screen (where you will need to Unlock the panel) before you can clear the message.

Touching the Error/Warning/Reminder/Info Icon on the Message Screen will take you to the System Information Screen to allow for troubleshooting over the phone or for a field service tech to better understand what is going on. Exiting the System Information Screen will take you back to the Message Screen in that situation.

# APPENDIX

## The finer details of the spa controls

### spaTouch™ 3 Panel Compatibility

spaTouch™ 3 panels are compatible with all BP systems that already support the TP800 panel and/or the TP900 panel (B). If a spaTouch 3 panel is used with a system that supports only the TP400 panel and/or TP600 panel (A), many screens will work correctly, and the spa screen will try to display all of your equipment, but in some cases it may not display correctly.

### Panel Models

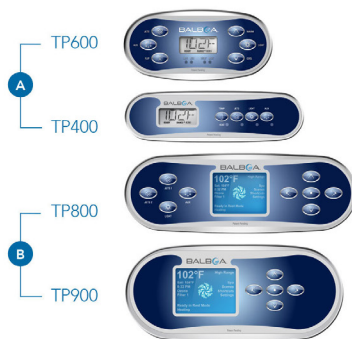

## ⚠ WARNING

### Qualified technician required for service and installation

#### Basic Installation & Configuration Guidelines

Use minimum 6AWG copper conductors only.  
Torque field connections between 21 and 23 in lbs.  
Readily accessible disconnecting means to be provided at time of installation.  
Permanently connected power supply.  
Connect only to a circuit protected by a Class A Ground Fault Circuit Interrupter (GFCI) or Residual Current Device (RCD) mounted at least 5' (1.52M) from the inside walls of the spa/hot tub and in line of sight from the equipment compartment.  
CSA enclosure: Type 2  
Refer to Wiring Diagram inside the cover of the control enclosure.  
Refer to Installation and Safety Instructions provided by the spa manufacturer.

**Warning:**  
People with infectious diseases should not use a spa or hot tub.

**Warning:**  
To avoid injury, exercise care when entering or exiting the spa or hot tub.

**Warning:**  
Do not use a spa or hot tub immediately following strenuous exercise.

**Warning:**  
Prolonged immersion in a spa or hot tub may be injurious to your health.

**Warning:**  
Maintain water chemistry in accordance with the Manufacturers instructions.

**Warning:**  
The equipment and controls shall be located not less than 1.5 meters horizontally from the spa or hot tub.

#### Warning! GFCI or RCD Protection.

The Owner should test and reset the GFCI or RCD

#### Warning! Shock Hazard! No User Serviceable Parts.

Do not attempt service of this control system. Contact your dealer or service organization for assistance. Follow all owner's manual power connection instructions. Installation must be performed by a licensed electrician and all grounding connections must be properly installed.

#### CSA Compliance/Conformité

##### Caution:

- Test the ground fault circuit interrupter before each use of the spa.
- Read the instruction manual.
- Adequate drainage must be provided if the equipment is to be installed in a pit.
- For use only within an enclosure rated CSA Enclosure 3.
- Connect only to a circuit protected by a Class A ground fault circuit interrupter or residual current device.
- To ensure continued protection against shock hazard, use only identical replacement parts when servicing.
- Install a suitably rated suction guard to match the maximum flow rate marked

##### Warning:

- Water temperature in excess of 38°C may be injurious to your health.
- Disconnect the electrical power before servicing.

##### Attention:

- Toujours vérifier l'efficacité du disjoncteur différentiel avant d'utiliser le bain.
- Lire la notice technique.
- Lorsque l'appareillage est installé dans une fosse, on doit assurer un drainage adéquat.
- Employer uniquement à l'intérieur d'une clôture CSA Enclosure 3.
- Connecter uniquement à un circuit protégé par un disjoncteur différentiel de Class A.
- Afin d'assurer une protection permanente contre le danger de choc électrique, lors de l'entretien employer seulement des pièces de rechange identiques.
- Les prises d'aspiration doivent être équipées de grilles convenant au débit maximal indiqué.

##### Avertissement:

- Des températures de l'eau supérieures à 38°C peuvent présenter un danger pour la santé.
- Déconnecter du circuit d'alimentation électrique avant l'entretien.

##### Warning/Advertissement:

- Disconnect the electric power before servicing. Keep access door closed.
- Déconnecter du circuit d'alimentation électrique avant l'entretien. Garder la porte fermée.

# Cal Connect™



## TABLE OF CONTENTS

CONTROLMYSPA™ SYSTEM OVERVIEW   01	3
GATEWAY ULTRA HARDWARE CONNECTIONS   02	5
CMSTM CODE OVERVIEW   03	7
SETTING UP THE CONTROLMYSPA™ APP   04	9
CONTROLMYSPA™ WEBSITE – SPA OWNER OVERVIEW   05	17

ControlMySpa™ was built to provide the Spa Professionals with real-time access to the tub so you will think you are actually standing next to it. And, for your Customer, peace of mind, new app features, the ability to schedule events and equip smart heating so your spa is ready to go when you are.

# WELCOME TO CONTROLMYSPA™

## Overview

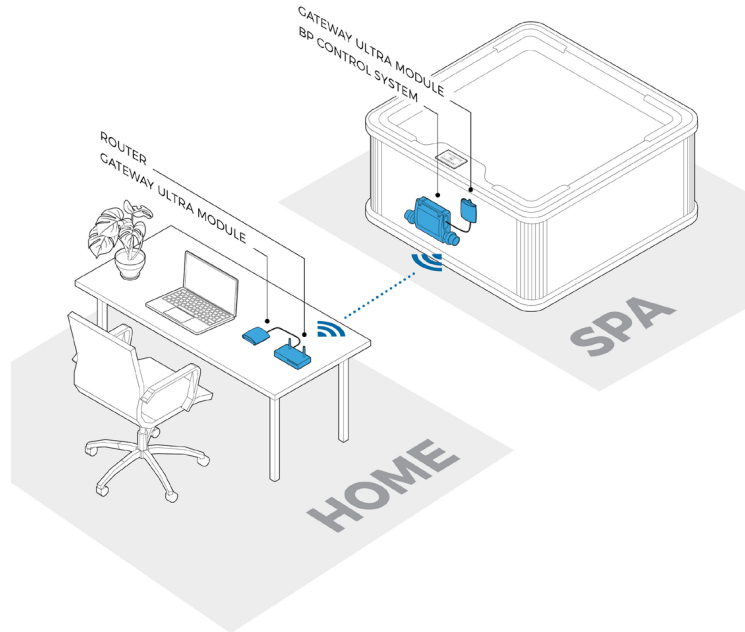

## ControlMySpa™

### CMS™ SYSTEM CONSISTS OF:



WEBSITE

ControlMySpa™ website with  
Login and access to spas

### CMS™ GATEWAY ULTRA Modules



Home Module

Spa Module

### SMARTPHONE | TABLET



iOS (Apple) ControlMySpa™  
mobile app and/or Android  
ControlMySpa™ Mobile app

The ControlMySpa™ system consists of:

- ControlMySpa™ GATEWAY ULTRA installed on a spa/Hot Tub
- iOS (Apple) ControlMySpa™ mobile app or Android ControlMySpa™ mobile app
- ControlMySpa™ website with log-in and access to spas



The ControlMySpa™ Logins:

- The iOS or Android ControlMySpa™ apps can only be accessed with an owner log-in
- The ControlMySpa™ website can be accessed with an owner log-in.

# ControlMySpa™

## GATEWAY ULTRA Hardware Connections

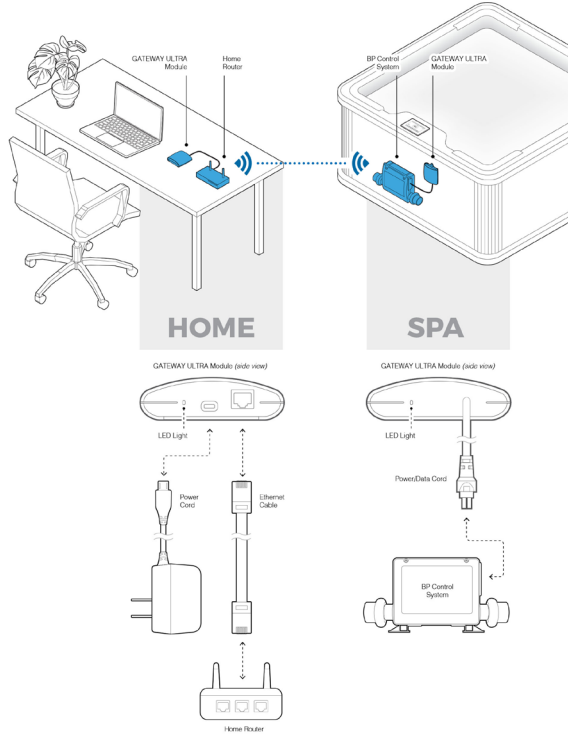

# ControlMySpa™

## Connect GATEWAY ULTRA hardware in your home

### Step 1

Plug the supplied ethernet cable into the home router (A).

### Step 2

Plug the other end of the ethernet cable into the GATEWAY ULTRA module (B).

### Step 3

Plug the supplied power cord into the GATEWAY ULTRA module (C).

### Step 4

Plug the other end of the supplied power cord into wall power (D).

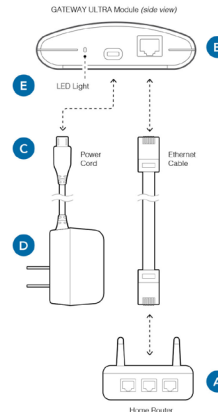
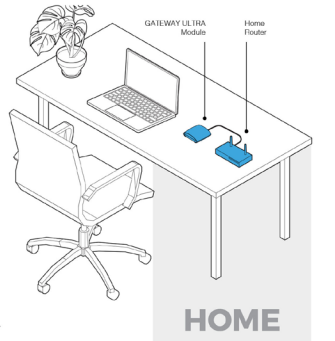

### LED Light Chart (E)

This chart applies to the home and spa GATEWAY ULTRA modules.

- Red - Solid: The GATEWAY ULTRA and the spa are not connected.
- Red - Blinking: Home and spa GATEWAY ULTRA modules are connected, but no connection to the spa controller.
- Blue - Blinking: Remote software update is underway. Do not unplug power.
- Green - Blinking: CMS™ GATEWAY ULTRA spa and home modules RF is connected, but no connection to internet.
- Green - Solid: Spa successfully connected to internet. No errors.



# ControlMySpa™ App for the smart device

## FOR IPHONE® OR IPAD® (IOS/APPLE)

Search the Apple iOS App Store for “controlmyspa”

Or Use this link: <https://goo.gl/j31t1V>



## FOR ANDROID® PHONES/TABLETS

Search Google Play App Store for “controlmyspa”

Or Use this link: <https://goo.gl/CG4Yci>



# Control your tub from your smart device.

# ControlMySpa™

## CMS™ Code Overview

### WHAT IS A CMS™ CODE?

- CMS™ Code is an 8 digit letter/number combination that all Spa owners must have to use spas equipped with the ControlMySpa™ system
  - A. The CMS™ code is obtained from your Dealer.
- Spa owners will need this CMS™ code to setup and connect their spas in the ControlMySpa™ database.
- The CMS™ code connects your spa to your OEM and Dealer for service and support

### EXAMPLE CMS™ Code: ABC-12345

**ABC** = 3 letter code unique to each spa Manufacturer or OEM  
**12345** = 5 number code unique to each spa Dealer or Distributor

42315\_Rev. B

ControlMySpa™ Spa Owner User Guide 9

## ControlMySpa™ Setup Spa Owner User Account



**1.**  
**Open the app on  
 your smart device**

Press "SETUP" on the app.

**2.**  
**Press "Next"**

Confirm Bluetooth is ON in the  
 iOS Settings.

# ControlMySpa™ Setup Spa Owner User Account

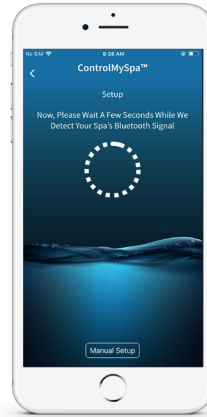
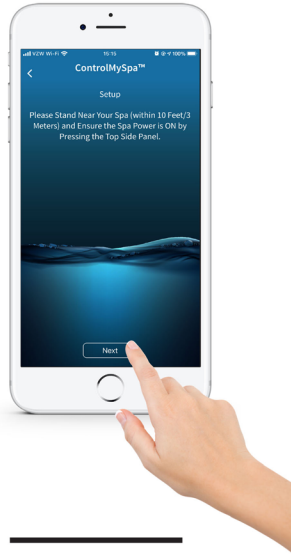

### 3. Press "Next"

Stand near your spa (within 10 feet/3 meters) and ensure the spa power is ON by pressing the topside panel. If the spa is powered ON, press "Next".

### 4. Detect Bluetooth

# ControlMySpa™ Setup Spa Owner User Account

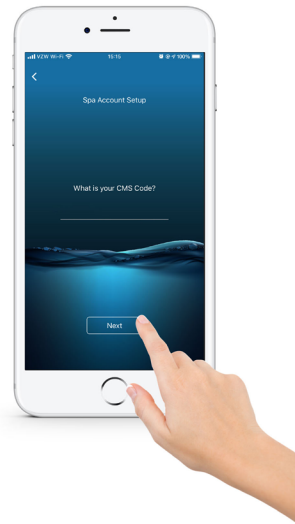
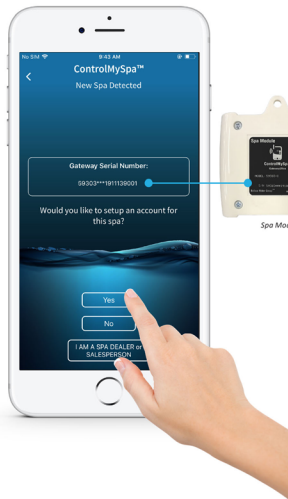

### 5. Press "Yes"

The serial number in the app should match the serial number on the back of the spa module.

### 6. Press "Next"

The CMS code is provided by your Dealer. Press "Next".

## ControlMySpa™

### Setup Spa Owner User Account

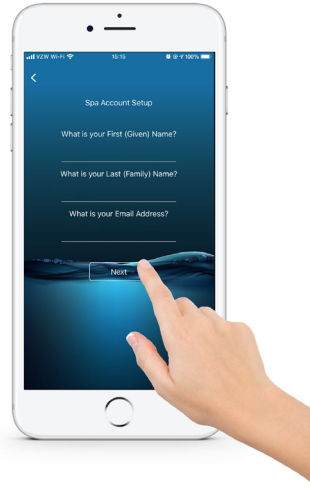

#### 7. Press "Next"

Input information and press "Next".



#### 8. Press "Next"

Input information and press "Next".

## ControlMySpa™

### Setup Spa Owner User Account

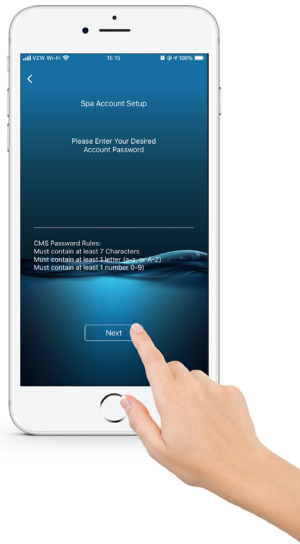

#### 9. Press "Next"

Input information and press "Next".

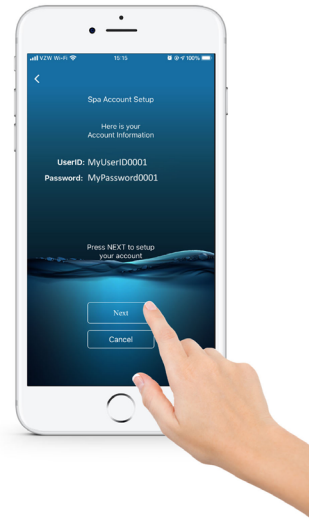

#### 10. Press "Next"

Your UserID and password will appear. Press "Next".

# ControlMySpa™ Setup Spa Owner User Account



**11.**  
Press "Close"

**12.**  
Press "SIGN IN"

Input your email address, password and press "SIGN IN".

# ControlMySpa™ Setup Spa Owner User Account

**SUCCESS! YOUR ACCOUNT IS SETUP, AND YOU CAN CONTROL YOUR SPA WITH THE CMS APP.**

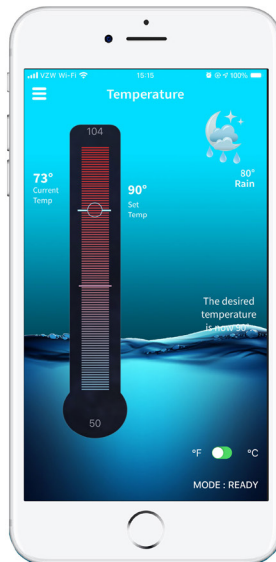

## ControlMySpa™ Spa Owner Account Password

**THE USER ACCOUNT EMAIL WILL RECEIVE AN AUTOMATED EMAIL:**

At the e-mail address provided in the set-up, this email provides the new user their **LOG-IN** and **PASSWORD**.

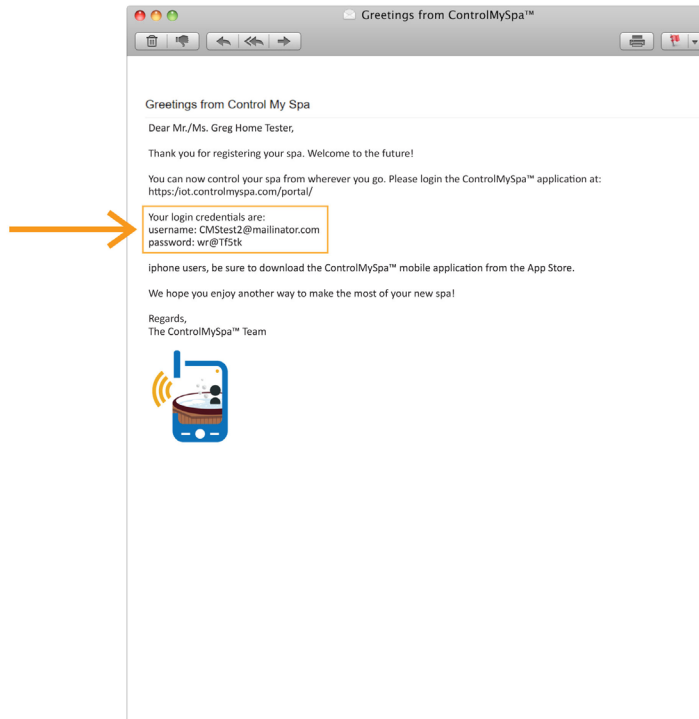

# ControlMySpa™ Website Overview

## SPA OWNER

# ControlMySpa™

## Spa Owner Overview

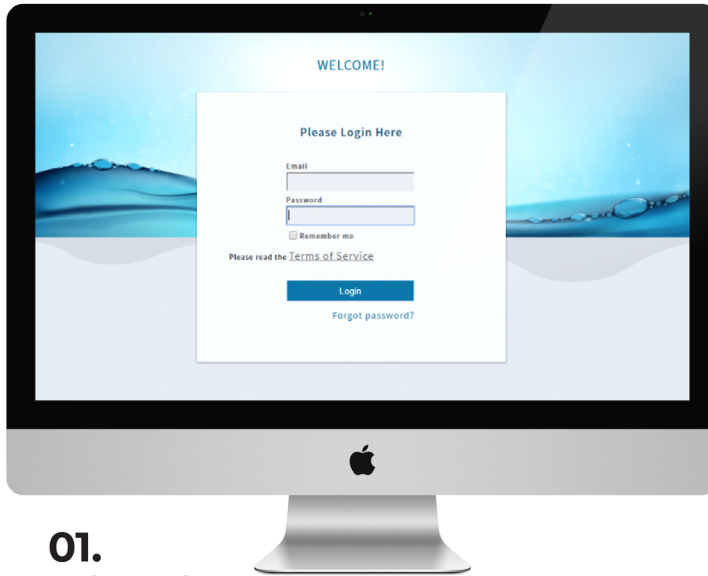

### 01. Web Portal Login

<https://controlmyspa.com>

#### Login & Password

- Go to <https://controlmyspa.com> on a computer or tablet web browser.
- You can also use a phone web browser, but works best on a computer or tablet
- Google Chrome browser is recommended, but works with most other browsers

# ControlMySpa™

## Spa Owner Overview

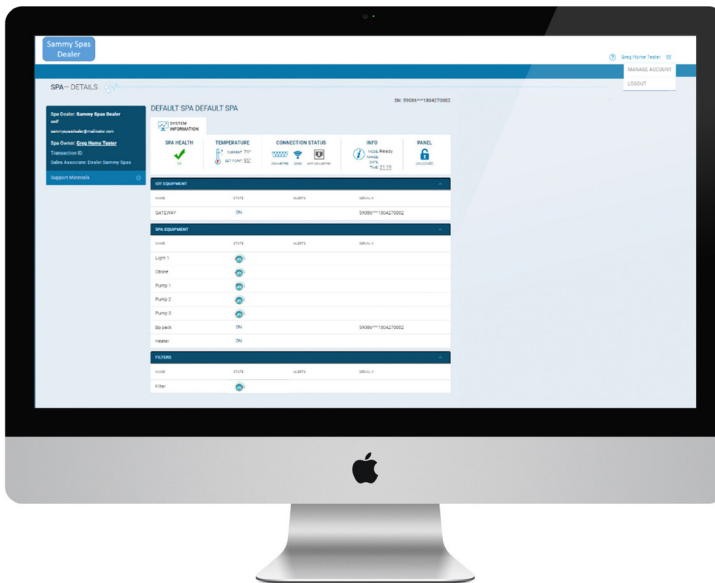

SPA VIEW PAGE

## ATS Plus Therapy System



### Adjustable Therapy System

#### Pump On / Off Button:

Press this button once to turn on the ATS pump. The pump will turn on full speed with letter "H" displayed in the seven segment LED, the Pump LED light on the control panel will appear and the back light will turn on if it was off previously. Press this button a second time to turn off the ATS pump, the Pump LED light, and clear the seven segment display. The ATS pump must be on before you can use any other features of this system.

#### Pulse Mode Button:

Press this button once to turn on the pulse mode. The last pulse mode number will be displayed and the ATS pump will run in the pulse mode that it displays. There are total of 9 pulse modes and user can choose the Up or Down button to select the desired pulse mode. Press this button a second time to turn off pulse mode and return to normal pump on with letter "H" displayed. See the image for 9 pulse mode descriptions.

#### Up / Down Buttons:

These buttons only activate when pulse mode is on. They allow you to cycle through 9 pulse modes. At the end of pulse mode 9, if the Up button is pushed the system will go to "DEMO" mode. In DEMO mode, the system will cycle through all 9 pulse modes with 30 seconds for each mode and flashing letter "d1" through "d9" while cycling through each pulse mode. At the end of demo mode 9, the system will exit the demo mode and return to normal Pump On with letter "H" displayed.

#### Time Out:

The Pump On will run for 15 minutes, then automatically shut off. If the Pulse Mode button is pressed during this time, the timer will reset and allow Pulse Mode to run for 15 minutes, then automatically shut off. For another 15 minutes session, press the Pump On and the Pulse Mode button. Back light will timeout 30 minutes after Pump Off.

#### Pump Protection:

If the pump is getting too hot during pulse mode (or after stop), the Pulse Mode will stop and ATS system will automatically go to a cool down cycle. During cool down cycle, the pump will turn on full speed with flashing letter "C" displayed in the panel. The ATS system will run 5 minutes and then turn off. Pulse Mode is disabled during cool down cycle.

#### Pump Purge:









To prevent water stagnation for a long time in the ATS system, the ATS system will purge water once a day. Every 24 hours from the last system run, the ATS system will turn on full speed for 20 seconds with flashing letter "P" displayed in the panel.

#### ATS Sensor:

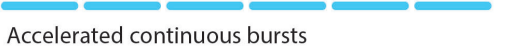
ATS sensor is used to monitor temperature to prevent ATS system from freezing or getting too hot. If temperature is too cold, the ATS system will turn on full speed with flashing letter "F" displayed in the panel. If it is too hot, the system will turn on full speed with flashing letter "C" displayed in the panel. In these cases, it will run until pump temperature goes back to normal and the system will shut down automatically.

If ATS sensor is not connected or not mounted to the system correctly, a flashing letter "E" will display in the panel when system is not running. With sensor error (flashing "E"), ATS system is still be able to operate normally but after the first 15 minutes of pulse mode, a flashing "L" will display in the panel. After the second 15 minutes of pulse mode, the system will force a cool down cycle for 30 minutes before user can use it again. There will be no freeze protection for sensor error and in some pulse modes the system will run very hot so user should fix the problem as soon as they can to enhance the pump life.



- 1  Low rolling bursts
- 2  Medium continuous bursts
- 3  Accelerated continuous bursts
- 4  Swift rolling bursts
- 5  3 gentle bursts followed by 1 vigorous burst
- 6  Quick, powerful continuous bursts
- 7  Gentle, powerful alternating bursts
- 8  Medium low rolling bursts
- 9  Extended low rolling bursts



## Electrical Power Efficiency

Your new spa comes equipped with an electric heater. Following the directions listed below will ensure the most efficient operation:

NOTE: This method is only for spa usage under two hours a week.

- Keep the spa's operating temperature 5°F below the desired usage temperature when not in use. One or two hours before use, set the temperature to the desired temperature.
- If the spa usage exceeds two hours a week, the set temperature should remain at the desired usage temperature.
- The air venturis should be used sparingly. When open, water temperature drops quite rapidly and can also dissipate chemicals.

Allowing the water temperature to lower more than 10°F below the desired usage temperature and reheating it prior to usage will cause the heater to operate longer than it normally would maintaining the desired temperature. Doing this will increase your operating cost and makes your heater work more than necessary.

## Jets

Almost all of the jets in your spa are adjustable. Rotating the face of an adjustable jet to the left (counter-clockwise) will decrease the amount of water flow through the jet. Rotating the face of an adjustable jet to the right (clockwise) will increase the amount of water flow through the jet. (See example shown below.)

Neck jets adjust in the opposite directions (counter-clockwise to increase, clockwise to decrease).



## LED Lighting

Press the LIGHT button on the topside control panel to turn the spa light on. If your spa has perimeter LED lights, they will also light up at the same time as the spa light.

The LEDs operate in three modes:

**1. Cycle:** When you continually press the LIGHT button, the LEDs will cycle through the three main LED colors (Red, Green, and Blue) or combinations of the three that produce the following colors: light green, purple, light blue, yellow, etc.

Each time you press the button, you immediately advance to the next color in sequence or eventually a different light pattern.

**2. Flashing:** When you are cycling through all the colors, the next time you push the LIGHT button, the LED lights may start flashing. This is another normal operational pattern option.

**3. Fading cycle:** The next phase of operation when you push the LIGHT button is a slow and/or fast fade random transition from one color to the next.

- If a spa is equipped with more than 100 points of light, the Slow Fading Cycle will flicker during a color change.
- Every air valve and water valve is equipped with 4 LED points.
- Every jet is equipped with 2 LED points.
- Perimeter LEDs take 9 points of light.
- The waterfall takes 4 points of light.

Spas with exterior corner LED lighting generally work in the same mode as described above. The variations in color and patterns provide you with multiple options to suit almost any lighting preference.

## Diverter Knobs

Diverter knobs are 1" and 2" knobs located around the top of your spa. They allow you to divert water through jets from one side of the spa to the other, or in most cases from floor jets to wall jets. This is accomplished by rotating the diverter knob to the left (counterclockwise), decreasing the amount of water flow through a section of jets. To increase the amount of water flow through the other section of jets, rotate the handle to the right (clockwise).



## Waterfalls

Some spa series include optional waterfalls. When the booster pump is on, rotate the dial on top (for the cascade waterfall) or turn the knob (for the hydro streamer -- see below).



## Air Venturis

Air venturis are the 1" knobs located around the top of your spa. Each one will let you add a mixture of air with the jet pressure. This is accomplished by rotating the air venturi knob to the left (counterclockwise) to increase the amount of airflow through the jets. To decrease the amount of airflow through the jets, rotate the handle to the right (clockwise).



## Hydro Streamer Waterfall

Your spa may include two to eight streamer waterfalls. When the booster pump is on, turn the 1" diverter knob to adjust the rate of flow to the waterfall jets.

The waterfall jet faces are not adjustable. Do not turn the jet faces because you may accidentally remove them.

Always shut off water to the hydro streamer jets before you place the cover on the spa. Water from the hydro streamer jets sprays in an arc that is higher than the top surface of the spa. When water from the hydro streamer sprays the bottom of the cover, it will collect and run to the edge of the spa and drip over the top.



# Water Clarity

This section is intended for new spa owners with no experience with water chemistry. Everyone's experience with maintaining water quality is different, but there are some general concepts you need to know.

Water maintenance is not difficult, although it requires regular attention. The most important thing to understand about taking care of your spa water is that preventive action is much easier than correcting water quality issues.

## The Key to Clear Water

Excellent water quality is a simple matter of four things:

**Chemical Balance**

You will need to test and adjust the chemical balance of your spa water. Although this is not difficult, it needs to be done regularly.

Depending on your choice of sanitizer, you need to test the level of calcium hardness, total alkalinity, and pH. Spa owners with a Cal Clarity II bromine generator also need to check total dissolved solids and phosphates.

See page 58 to learn how to balance your spa water.

**Sanitation**

Sanitizers kill bacteria and viruses and keep the water clean. A low sanitizer level will allow microbes to grow quickly in the spa water. We recommend using either chlorine or bromine as your sanitizer.

Spa owners with an ozonator also need to add sanitizer, although their requirements are different.

See page 59 to learn how to use sanitizer.



**Filtration**

Cleaning your filter regularly is the easiest and most effective single thing you can do to keep your water clear.

A clogged or dirty filter will cause the heater and pump to work harder than they need to, possibly causing them to fail.

The spa's heating system will only function with the proper amount of water flow through the system.

See page 60 for filter cleaning instructions.

**Regularity**

Clear water requires regular maintenance. Establish a routine based on a regular schedule for your spa water maintenance.

Maintaining your water quality helps the enjoyment of your spa and extends your spa's life by preventing damage from neglect and chemical abuse.

See page 61 for the schedule of recommended maintenance.

## Testing and Adjusting Spa Water

You have two types of testing methods to choose from:

- **The reagent test kit** is a method which provides a high level of accuracy. It is available in either liquid or tablet form.
- **Test strips** are a convenient testing method commonly used by spa owners.

### Balancing the Total Alkalinity

Total alkalinity (TA) is the measure of the total levels of carbonates, bicarbonates, hydroxides, and other alkaline substances in the water. TA can be considered a “pH buffer”. It is the measure of the ability of the water to resist changes in pH level.

**The recommended total alkalinity is 80 - 120 ppm.**

If the TA is too low, the pH level will fluctuate widely from high to low. Low TA can be corrected by adding an alkalinity increaser

If the TA is too high, the pH level will tend to be too high and may be difficult to bring down. High TA can be corrected by adding an alkalinity decreaser.

When the TA is balanced, it normally remains stable, although adding water with high or low alkalinity will raise or lower the TA level.

### Balancing the Calcium Hardness

Calcium hardness (CH) is a measure of the total amount of dissolved calcium in the water. Calcium helps control the corrosive nature of the spa’s water and is why soft water is not recommended. The low calcium content of soft water is very corrosive to the equipment and can cause staining of the spa shell.

**The recommended calcium hardness is 150 - 200 ppm.**

If the CH is too low, add a calcium hardness increaser.

If the CH is too high, dilute the spa water with soft water.

When the CH is balanced, it normally remains stable, although adding soft water or very hard water will raise or lower the CH level.

### Balancing the pH

The pH level is the measure of the balance between acidity and alkalinity.

If the pH is too low, it can cause corrosion of metal fixtures and the heating element. Low pH can be corrected by adding a pH increaser.

If the pH is too high, it can cause scaling by allowing metals or minerals to form deposits and stain spa surfaces. High pH can be corrected by adding a pH decreaser.

### Ideal Water Chemistry

Testing For:	Ideal Range (ppm)	
	Minimum	Maximum
Total Alkalinity	80	120
Calcium Hardness	150	200
pH	7.2	7.6

## Sanitation

Sanitizers kill bacteria and other organic waste by breaking them down to non-harmful levels and are filtered out. Before you fill your spa, you need to decide which chemical sanitizer you wish to use. Consult your Cal Spas dealer for the right decision with regards to your lifestyle and spa usage.

We recommend either **bromine** or **chlorine** as your sanitizer. Both work well when maintained regularly.



**DO NOT use trichlor. Trichlor is very acidic and the hot temperature of the spa causes it to dissolve too quickly. It will cause damage to your spa and will void your warranty.**

Whichever plan you decide on, follow it completely and don't take shortcuts. It will provide you with clean, safe, clear spa water with a minimum of effort. Spa owners with an ozonator still need to use a chemical sanitizer. See page 61 for a description of how the ozonator works.

### Using Chlorine as a Sanitizer

If you choose to use chlorine as a sanitizer, only use granulated chlorine, not liquid chlorine.

Once a week, check the chlorine level using either a test strip or a reagent kit. See the table on the following page for the ideal range.

Add one or two tablespoons granulated chlorine to the spa water weekly. Note that chlorine dissipation rate will be faster at higher water temperatures and slower at lower temperatures.

When you add chlorine, open all of the jets and run the spa at high speed with the cover open for at least 30 minutes.

Follow the maintenance schedule on page 61.

### Using Bromine as a Sanitizer

Bromine is a very effective sanitizer that produces low chemical odors. Unlike chlorine, it can break down bacteria and other impurities to a safe level with a low burn-out rate.

Use granulated sodium bromide to establish your bromine base.

When you begin with fresh water, add two ounces of granulated bromide. Open all of the jets and run the spa at high speed with the cover open for at least 30 minutes.

Follow the maintenance schedule on page 61.

### Shocking the Water

In addition to using a chemical sanitizer, you will periodically need to shock the water. Shocking the water helps remove burned-out chemicals, bacteria, and other organic material from your spa's water and improves your sanitizer's effectiveness.

Do not use chlorinating shock, which will damage your spa's jets and pump seals. Only use an oxidizer shock. It can be used with either chlorine or bromine sanitizers.

Add two ounces of oxidizer shock per 500 gallons once a week, after heavy bather loads, or if water has a strong odor.

Spa must be running with all of the jets on high for 30 minutes with the cover open. If necessary, repeat oxidizer shock in 30 minute intervals.

Testing For:	Ideal Range (ppm)	
	Minimum	Maximum
<b>Chlorine level</b>		
Without ozonator	3.0	5.0
With ozonator	2.0	4.0
<b>Bromine level</b>		
Without ozonator	6.7	11.0
With ozonator	5.7	10.0

## Bather Load

“Bather Load” is the term used to describe the number of people using a spa, combined with the length of usage, and the frequency of usage. All these factors have a great effect on the spa water. The higher the bather load, the more chemicals need to be added and a longer filtration time will be needed.

Recommendations are designed for spas with average bather load (3 to 4 people, 15 minutes of usage, three times a week at 100 degrees) If your bather load exceeds these guidelines, and you experience water quality problems, increase the amount of filtration first, (go to the next higher filtration number) then if water quality is still not adequate, consult the advice of your Cal Spas dealer for additional chemical or system recommendations. Be sure to give them your bather load information.

## Filter Cleaning

The filter is the part of your spa that removes the debris from the water and needs to be cleaned on a regular basis to maximize your spa’s filtering performance and heating efficiency.

In addition to spraying off the filter weekly to remove surface debris, your filter should be deep cleaned periodically to dissolve scale and particles that get lodged deep within the filter fibers and impede the filtration process. Even if the filter looks clean, scale and particles can clog the fibers and prevent water from flowing through the filter resulting in the most common spa problem—no heat, caused by a dirty filter.

We recommend you clean your filter once a month and replace it once a year or as necessary.

**It is extremely important that you never run the spa without a filter. There is a possibility that debris may be sucked into the plumbing through the filter well.**

### Cleaning the filter

1. Remove the filter by unscrewing it and pulling it up and out.
2. Place the dirty filter into a bucket of water deep enough to cover the filter. Add 8 oz of liquid filter cleaner to the bucket of water.

**Note:** It is a good idea to keep a spare filter to use in the spa while the dirty filter is being deep cleaned. This way, you can rotate the filters and both will last longer.

3. Soak the filter for a minimum of 24 hours.
4. Spray the filter with a water hose. Spray each pleat carefully.
5. Reinstall the filter. Do not overtighten.

## Water Sanitation

The spa’s control system is factory-programmed with one filter cycle that will run in the evening when energy rates are often lower. The time and duration of the filter cycle can be set according to your needs. In addition, a second filter cycle can be enabled. Filtration time may need to be increased with heavy bather load.

See instructions for setting filtration cycles on page 15.

## Ozonator

The ozone generator releases ozone into the spa water. You will still need to test for chlorine or bromine and occasionally replenish it to return the sanitizer level to the baseline.

For spas without a circulation pump, pump 1 will run at low speed and the ozonator will run during filtration.

For spas with a circulation pump, the ozonator will run with the circulation pump.

The spa's control system is factory-programmed with one filter cycle that will run in the evening when energy rates are often lower. The time and duration of the filter cycle can be set according to your needs. In addition, a second filter cycle can be enabled. Filtration time may need to be increased with heavy bather load.

See instructions for setting filtration cycles on page 15.

## Maintenance Schedule

<b>Each time you refill the spa</b>	Follow the section "Filling and Powering Up Your Portable Spa" on page 9.
<b>Prior to each use</b>	Test the spa water using either test strips a reagent test kit. Adjust chemical levels as necessary.
<b>Once a week</b>	Test the spa water using either test strips a reagent test kit. Adjust chemical levels as necessary. If your water source is high in calcium, add stain and scale preventer.
<b>Once a month</b>	Deep clean your spa's filter. (Follow filter cleaning instruction at beginning of this section.)
<b>Every two to four months</b>	Change the spa water. How often you change the water depends on how much you use the spa. When you change the water, you will need to: <ul style="list-style-type: none"> <li>• Clean and polish the acrylic surface (see page 68)</li> <li>• Clean and treat the spa cover and pillows (see page 68)</li> <li>• Deep clean the filter (see page 60)</li> <li>• Refill your spa (see page 9)</li> </ul>
<b>Once a year</b>	Replace filter cartridges if the pleats appear frayed.

## Troubleshooting Water Clarity Problems

Problem	Probable Causes	Possible Solutions
Cloudy Water	<ul style="list-style-type: none"> <li>• Dirty filter</li> <li>• Excessive oils / organic matter</li> <li>• Improper sanitization</li> <li>• Suspended particles / organic matter</li> <li>• Overused or old water</li> </ul>	<ul style="list-style-type: none"> <li>• Clean filter</li> <li>• Shock spa with sanitizer</li> <li>• Add sanitizer</li> <li>• Adjust pH and/or alkalinity to recommended range</li> <li>• Run jet pump and clean filter</li> <li>• Drain and refill the spa</li> </ul>
Water Odor	<ul style="list-style-type: none"> <li>• Excessive organics in water</li> <li>• Improper sanitization</li> <li>• Low pH</li> </ul>	<ul style="list-style-type: none"> <li>• Shock spa with sanitizer</li> <li>• Add sanitizer</li> <li>• Adjust pH to recommended range</li> </ul>
Chlorine Odor	<ul style="list-style-type: none"> <li>• Chloramine level too high</li> <li>• Low pH</li> </ul>	<ul style="list-style-type: none"> <li>• Shock spa with sanitizer</li> <li>• Adjust pH to recommended range</li> </ul>
Musty Odor	<ul style="list-style-type: none"> <li>• Bacteria or algae growth</li> </ul>	<ul style="list-style-type: none"> <li>• Shock spa with sanitizer – if problem is visible or persistent, drain, clean and refill the spa</li> </ul>
Organic buildup / scum ring around spa	<ul style="list-style-type: none"> <li>• Buildup of oils and dirt</li> </ul>	<ul style="list-style-type: none"> <li>• Wipe off scum with clean rag – if severe, drain the spa, use a spa surface and tile cleaner to remove the scum and refill the spa</li> </ul>
Algae Growth	<ul style="list-style-type: none"> <li>• High pH</li> <li>• Low sanitizer level</li> </ul>	<ul style="list-style-type: none"> <li>• Shock spa with sanitizer and adjust pH</li> <li>• Shock spa with sanitizer and maintain sanitizer level</li> </ul>
Eye Irritation	<ul style="list-style-type: none"> <li>• Low pH</li> <li>• Low sanitizer level</li> </ul>	<ul style="list-style-type: none"> <li>• Adjust pH</li> <li>• Shock spa with sanitizer and maintain sanitizer level</li> </ul>
Skin Irritation / Rash	<ul style="list-style-type: none"> <li>• Unsanitary water</li> <li>• Free chlorine level above 5 ppm</li> </ul>	<ul style="list-style-type: none"> <li>• Shock spa with sanitizer and maintain sanitizer level</li> <li>• Allow free chlorine level to drop below 5 ppm before spa use</li> </ul>
Stains	<ul style="list-style-type: none"> <li>• Total alkalinity and/or pH too low</li> <li>• High iron or copper in source water</li> </ul>	<ul style="list-style-type: none"> <li>• Adjust total alkalinity and/or pH</li> <li>• Use a stain and scale inhibitor</li> </ul>
Scale	<ul style="list-style-type: none"> <li>• High calcium content in water – total alkalinity and pH too high</li> </ul>	<ul style="list-style-type: none"> <li>• Adjust total alkalinity and pH – if scale requires removal, drain the spa, scrub off the scale, refill the spa and balance the water</li> <li>• Use a stain and scale inhibitor</li> </ul>



# Cleaning and Maintenance

## Removing and Reseating the Pillows

You can remove the pillows for cleaning and maintenance quickly and easily. This method works for all types of pillows.

Grab the lower edge of the pillow with both hands firmly and pull up. As you do this, the pillow inserts will pop out of the holes.

Reseat the pillows by aligning the pillow inserts with the holes and striking the pillow hard enough to insert the pegs back into the holes.

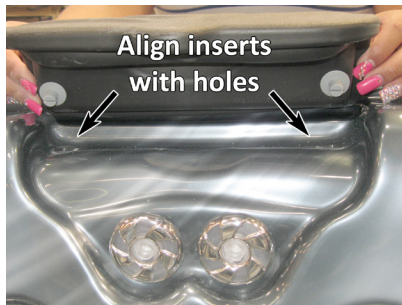

## Jet Remove/Replace

Jets can be easily removed for cleaning.

Grasp the outer rim of the jet and turn it counter-clockwise. The jet will unscrew from the fitting until it is free.

To replace the jet, place it in the fitting and turn it clockwise until it is snug in place. Do not overtighten the jet.

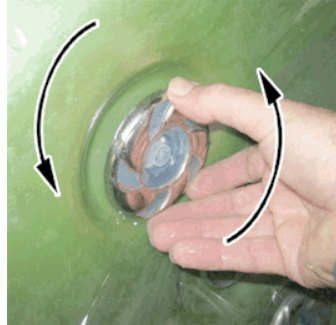

## Cleaning the Hydrostreamers

To ensure proper flow through the hydrostreamers, follow this maintenance process should any jet(s) have diminished flow.

1. Turn the jet counter-clockwise to remove the chrome jet head.



2. Pull the chrome cap off.



3. Pull the plastic jet opening and its gasket off.



4. Pull out the inner plastic filter.



5. The plastic filter is shown completely removed from its housing.



6. Tap the filter and/or blow out the debris to ensure all holes are clear.



7. Slide the plastic filter back in the jet.



8. Re-insert the gasket into clear plastic spout.



9. Place the gasket into the plastic spout and then insert the spout into the jet body.



10. Insert the plastic spout into the jet body.



11. Place the chrome ring cap back on and turn clockwise to tighten it down.



## Spa Cover and Locking System Installation

Important! Keep the spa covered when not in use!

- Covered spas will use less electricity in maintaining your set temperature.
- Covering your spa will protect your spa's finish from the sun's ultraviolet rays.
- You are required to keep the spa covered to maintain warranty coverage.
- Covering your spa helps prevent children from drowning in the spa.

In addition, while the spa cover is rigid, it is not designed to support any weight. Therefore, as a safety precaution and to preserve the life of your cover, you must not sit, stand, or lie on it, nor should you place objects of any kind on top of it.

**Step 1** - Place cover on spa. Make sure it is correctly positioned.



**Step 2** - Position the tie-down hardware (attached to the straps of your cover) on the side of the spa so they are easily reached by the cover tie-down straps.



**Step 3** - With the straps pulled taut (but not overly tight), lightly drill the location for screw placement. Gently drill 3 holes - one for each screw slot in the lock. (If you do not have a low torque drill, use the lowest torque setting on the drill you have.) DO NOT drill all the way in but instead just make a guide for starters.

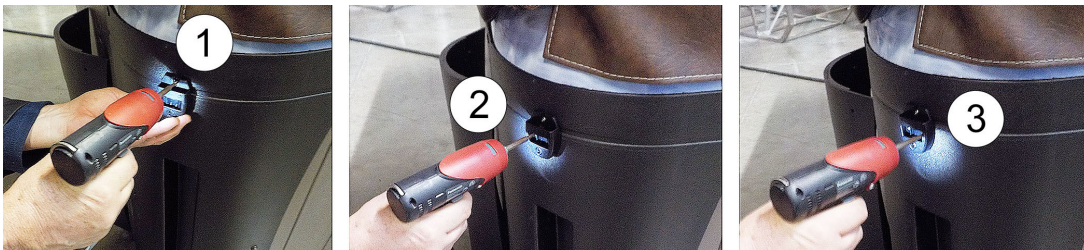

**Step 4** - Use a screwdriver to finish screwing in the 3 screws. (Repeat this process for the other 3 corners.)



**Step 5** - Keep the cover fastened down at all times when not in use. Locking hardware may be locked with a key (which is provided).



**Step 6** - The provided key will allow you to lock down spa access.

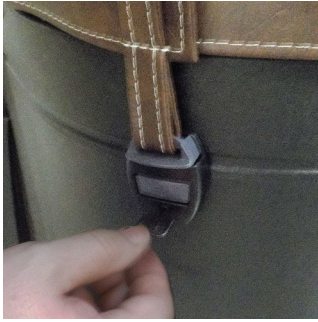

**WARNING  
AVOID  
DROWNING  
RISK**

FAILURE TO FOLLOW INSTRUCTIONS MAY RESULT IN INJURY OR DROWNING  
NON-SECURED OR IMPROPERLY SECURED COVERS ARE A HAZARD.  
REMOVE COVER COMPLETELY BEFORE ENTRY OF BATHERS.  
ENTRAPMENT POSSIBLE.  
KEEP COVER ON SPA AND LOCKED WHEN NOT IN USE

## Draining Your Portable Spa

Your spa should be drained every four to six months for cleaning and maintenance and refilled with fresh tap water. See page 68 for instructions on cleaning the shell, cover, and pillows. See page 9 for instructions on refilling your spa. Before you begin, turn off power to the spa at the breaker and remove all filters.

### 1. Locate your drain.

*All fitness spas have a cabinet mounted drain*

The location of the cabinet mounted drain is shown in the left photo by the arrow. (It is located to the right of the fitness spa's "door.") Pull the knob out of the cabinet. The cabinet drain is screwed into the drain pull knob.



### 2. Remove the cap

Make sure the valve is in the closed position, then unscrew and remove the cap.



### 3. Connect valve to a garden hose.

Attach a garden hose to the hose-bib fixture. Place the other end of the garden hose where you would like the water to drain.

### 4. Drain the spa.

Turn the valve on the hose-bib fixture to open the drain. When the spa has drained completely, turn the valve on the hose-bib fixture, remove garden hose, and replace the cap.

For all spas

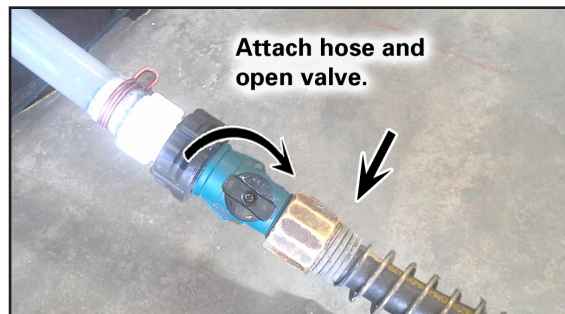

## Winterizing (Cold Climate Draining)

In many areas of the country, the temperature drops below 32°F (0°C). We recommend that you always have your spa full of water and running at normal spa temperatures (80°F to 100°F, 26.7°C to 37.8°C). This will help reduce the risk of freezing in your spa and your spa's equipment.

**Warning: If you find the need to drain your spa, be aware of the potential of freezing in your spas equipment and plumbing. Even if the directions below are followed perfectly, there is no guarantee that your spa will not suffer freeze damage. Freeze damage is not covered by your warranty.**

1. Open all filter covers.
2. Remove the filter baskets and filters.
3. Drain your spa completely as described in the instructions above.
4. Vacuum water from the spa's main drain fitting with a wet/dry vacuum.
5. Open the bleeder valves on the pumps.
6. Disconnect the unions from both sides of the pump.
7. Blow any remaining water out of the jets and equipment area with the wet/dry vacuum.
8. When it has completely finished draining, close the bleeder valves and re-connect the unions on the pumps. Replace the filter baskets and filters.
9. Cover your spa with a good spa cover and an all-weather tarp to ensure that neither rain nor snow enters the spa.

## Cleaning and Replacing the Filter

Filtration is one of the most important steps you can take to ensure clean, clear water. It is far less expensive to fix water clarity problems by filtering your spa than by using excessive amounts of chemicals, excessive filtration times, or by water replacement.

See the section "Filter Cleaning" on page 60 for more information.

## Vacation Care

You can leave your spa unattended for up to two weeks if you follow these instructions.

**ALWAYS lock your cover using the cover locks if you plan to be away from home and the spa is filled with water.**

1. Select the Low Range temp choice used for vacation mode. (See instructions on page 14 for vacation setting.)
2. Following the water quality instructions starting on page 57, adjust the pH.
3. Shock the water (add either chlorine or bromine sanitizer).
4. When you return, check and adjust the pH and shock the water.

If you will not be using your spa for longer than 14 days and a spa maintenance service is not available, we strongly recommend you drain or winterize your spa.

## Cleaning Your Spa

### Spa Cover and Pillows

Due to the constant punishment your spa cover and pillows receive, you should protect them by applying a vinyl and leather cleaner as part of your monthly maintenance plan. Use a product that is specifically designed to protect spa covers and pillows from chemical and ultraviolet light damage without leaving an oily residue behind that is normally associated with common automotive vinyl protectants.

**Warning: Do not** use automotive vinyl protectants on spa covers or pillows. These products are generally oil-based and will cause severe water clarity issues that are difficult to correct.

### Spa Shell

Each time you drain your spa, before you refill it you should clean your spa shell with an all-purpose cleaner and apply a coat of surface protectant.

Use a low detergent, non-abrasive cleaner specifically formulated to clean the spa without damaging its acrylic finish.

Use a non-oil based surface protectant that is specifically formulated to protect the spa's finish from the chemicals and minerals associated with normal spa use.

## Using the Freedom Sound System

The Freedom Sound System™ entertainment option contains a Bluetooth-enabled speaker system that is available for certain Cal Spa models. Any Bluetooth-enabled device can be used to play audio through your spa.



Before you can use the sound system, you need to pair the Bluetooth module with your device. The Bluetooth module is installed within the spa cabinet. Everything can be done with your device. The example shown below is from an iPhone device. Your device may appear differently. Before you begin, make sure Bluetooth is enabled on your device.

1. Select Bluetooth from your device's option list.
2. Select **SWA8-6BT...** from the list of available devices to pair.
3. Your iPhone device will ask for a code: the code is **0000**.
4. Allow your device to pair with the spa's Bluetooth module.
5. When the devices have been connected, the device **SWA8-6BT...** will be highlighted.

Only one Bluetooth device can be paired with the Freedom Sound System™ at any time.

(For Android users, the systems will pair automatically - no code is needed.)

Once your device is paired and connected, all sounds from your device will be played through the sound system, including system sounds and telephone.

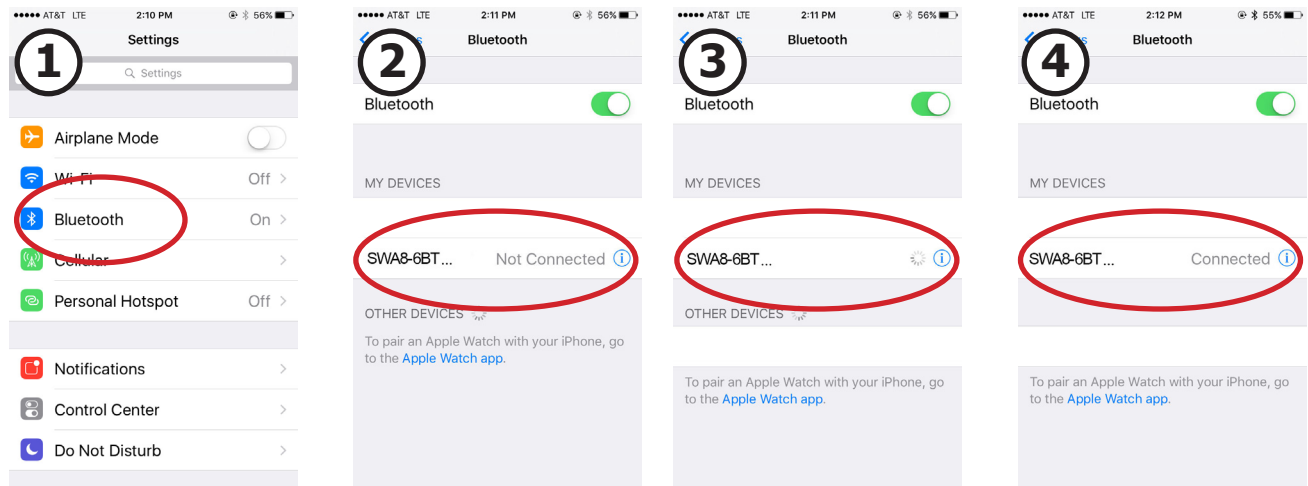

# Keeping Fit With Your Swim Spa

## Air Injection System

Use the control panel to start and stop the Air Injection System. The **JET 1** and **JET 2** buttons control the top and bottom jets.

Use the air venturi valves to inject air in the water streams for even more power.

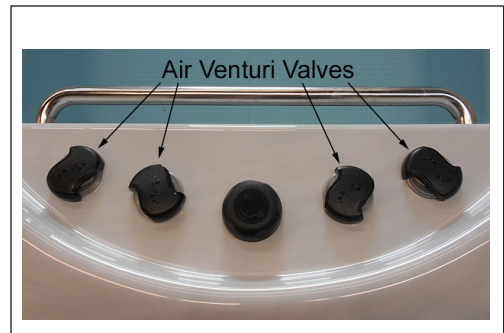
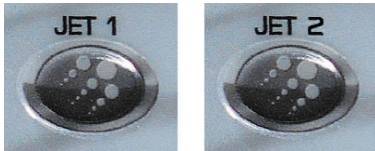

## Swim Tether

The swim tether pole has three pieces and assembles easily. Slide the ends of the top and middle sections into the middle and bottom sections.

Insert the tether in the anchor hole when you are ready to use it.

Buckle the strap around your waist. It is easily adjustable and can accommodate most sizes.



## Exercise Equipment

**IMPORTANT:** Always consult your physician before starting any exercise activity or program. The Ultimate Fitness series spas feature rubber exercise bands. When stretched, these bands create a high tension condition. Improper use or failure to connect the exercise bands properly may cause injury. Always inspect all of the exercise equipment prior to beginning any exercise. Do not use any damaged equipment.

This equipment attaches to the exercise anchors located on the spa walls.

### Connecting the Exercise Equipment

The drawings below show different ways the exercise kit can be connected depending on the exercises you wish to do.

### For 14 foot spas and model F-1222

The exercise kit contains:

- Two hand grips
- Two ankle braces
- Two 6" elastic bands
- Two 18" elastic bands
- Two 25" elastic bands
- Two rowing bars

### For 16 and 17 foot spas

The exercise kit contains:

- Two hand grips
- Two ankle braces
- Two 18" elastic bands
- Two 25" elastic bands
- Two 56" elastic bands
- Two rowing bars

When attaching the rowing bar, place the hook into the eye pad as shown.



Elastic bands attach to the eye pad as shown.

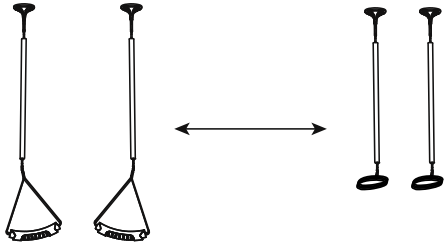

All elastic bands can be connected to either end of the spa and used with hand grips or ankle braces.

**Typical configuration for F-1222 spa**

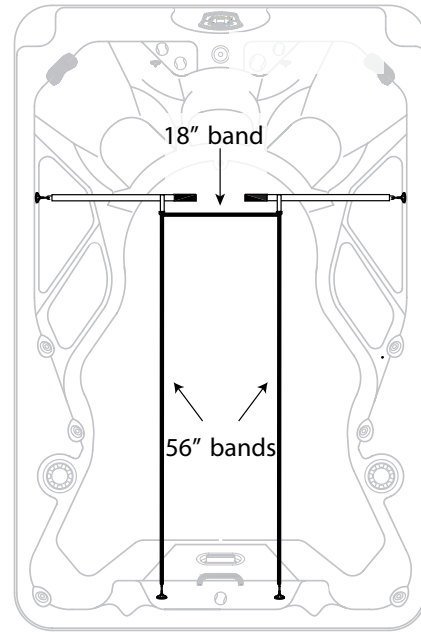

**Typical configuration for 16' and 17' spa**

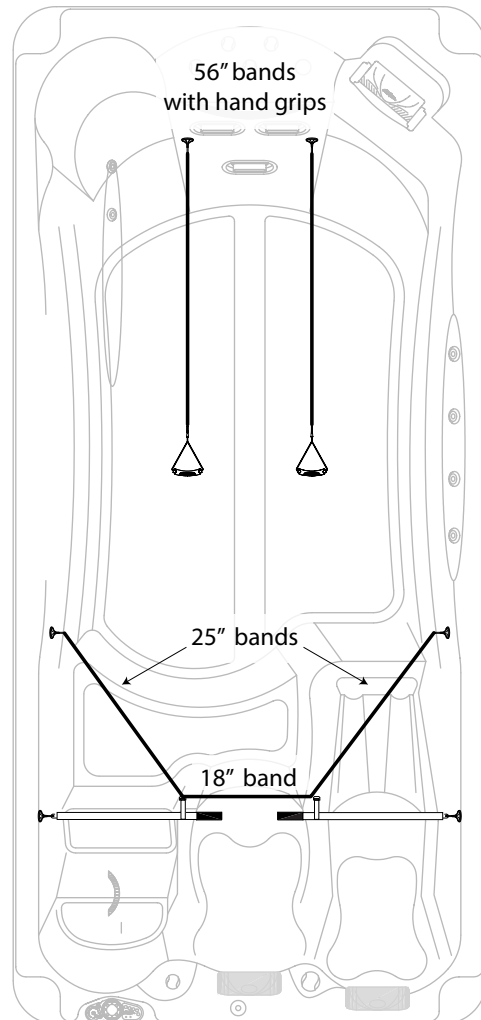

**Typical configuration for 12', 13', 14' spa**

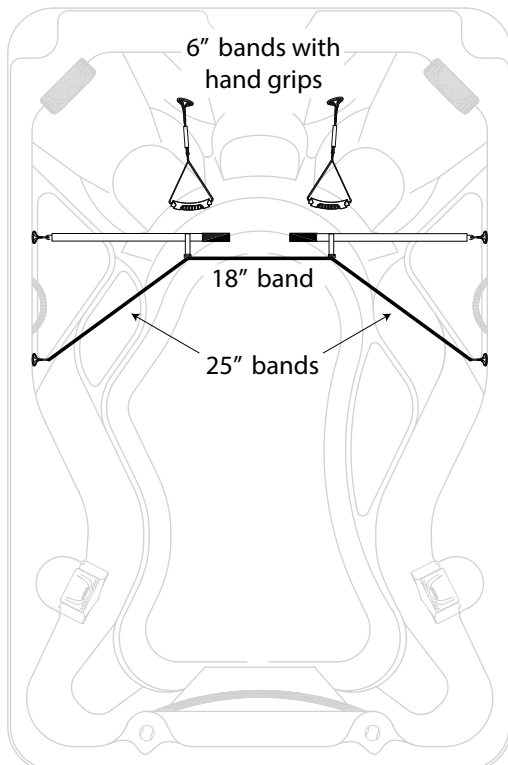





Please visit [www.quickspaparts.com](http://www.quickspaparts.com) to order your replacement parts.

# Appendix

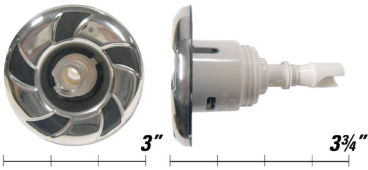
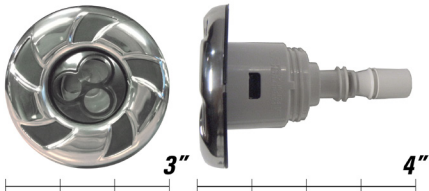
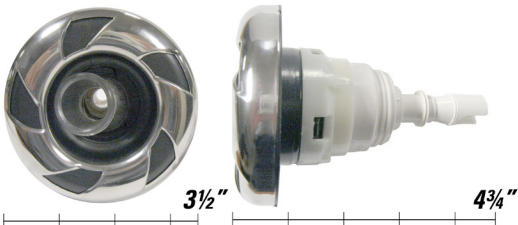
## Replacement Parts

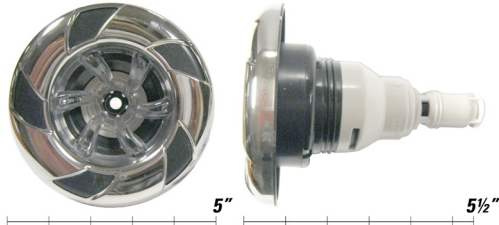
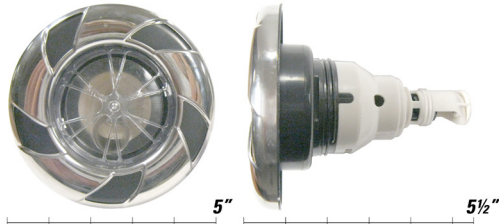
Jets Inserts - Screw-in
<p><b>ELE 2" Euro No Eyeball</b> PLUCS2295021SL</p> 
<p><b>MED 3" XL Cluster Storm Directional</b> PLUCS2295031SL</p> 
<p><b>mfd 3" Micro Flow Directional</b> PLUCS2295061SL</p> 
<p><b>MM 3" Mini Storm Massage</b> PLUCS2297061SL-8</p> 
<p><b>MFD 3.5" Maxi Flow Directional</b> PLUCS2295091SL</p> 

Jets Inserts - Screw-in
<p><b>PSD 5" Power Storm</b> PLUCS2295131SL</p> 
<p><b>PSR 5" Power Storm Riffed</b> PLUCS2295141SL</p> 
<p><b>PST 5" Power Storm Wagon Wheel</b> PLUCS2295191SL</p> 
<p><b>River Jet Assembly Black with Stainless Steel Rim 210-5101SCS</b> PLU210-5101SCS</p> 

**Jets Inserts - Screw-in**

**Power Stream Swim Jet**  
 PLU210-0821S

**Jets Inserts - Snap-in SQR**

**SQN candy cane, 2" neck jet, 100% shut-off**  
**Candy cane w/clear center**  
 PLU29923-144-000

**Waterfall**

**Flush Mount Water Feature Assembly (Clear)**  
 PLU210-9288S

**Pillows**

**Cascade Pillow No Insert Black**  
 ACC01401031

**Pillows**

**Y Pillow recess**  
 ACC01401101

**Infinity Pillow Plain Black**  
 ACC01401061

**Water Diverter Valves**

**Diverter Valve 2" Black/Titanium**  
 PLU21300465

**Diverter Valve 1" Black/Titanium**  
 PLU21300453

**Diverter Valve 1 1/2" On/Off ASSY (600-4601)**  
 PLU21100045

**Air Control Valve**

**Air Control Black/Titanium**

**Drains**

**Drain Super Hi Flo Suction 2 1/2" Black (640-3581LGV)**  
 PLU21400146

Drains	
<p><b>Low Profile Drain 3/4" Black (640-0511)</b></p> <p>PLU21400401</p>	

Teleweir Skimmer	
<p><b>Teleweir filter skimmer 50 sq. ft. (510-4601)</b></p> <p>FIL11700006</p>	

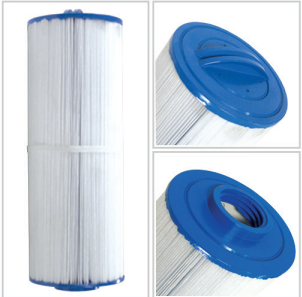
Filter	
<p><b>50 sq ft female threaded - antibacterial (for Teleweir skimmer shown above)</b></p> <p>FIL11100208</p>	

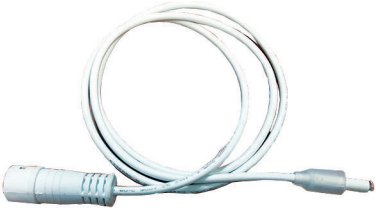
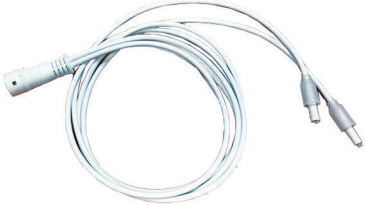
LED Lights	
<p><b>1-LED light string</b></p> <p>LIT16100330</p>	
<p><b>2-LED light string</b></p> <p>LIT16100331</p>	

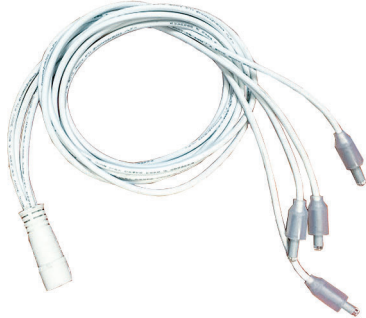
LED Lights	
<p><b>4-LED light string</b></p> <p>LIT16100332</p>	

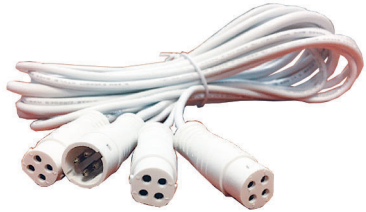
<p><b>1 to 3 ext. cord</b></p> <p>LIT16100335</p>	
---	---

<p><b>1 to 1 port ext. cord</b></p> <p>LIT16100338</p>	
--	--

<p><b>Interior light with logic (7 LED)</b></p> <p>LIT16100333</p>	
--	---

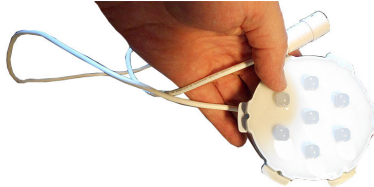
<p><b>Interior light without logic (7 LED)</b></p> <p>LIT16100337</p>	
---	---

<p><b>Main light housing, LED lens, fitting nut</b></p> <p>LIT16100336</p>	
--	---

Please visit [www.quickspaparts.com](http://www.quickspaparts.com) to order your replacement parts.

### Exercise Equipment

#### Exercise Kit for 12 Foot and 14 Foot Spas EXC12000008

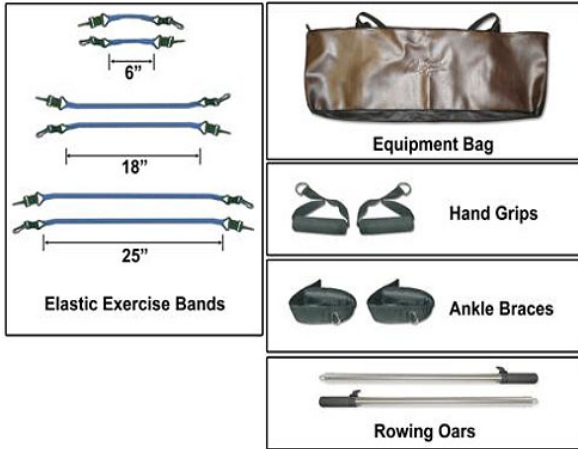

#### Exercise Kit for 16 Foot and 17 Foot Spas EXC12000007

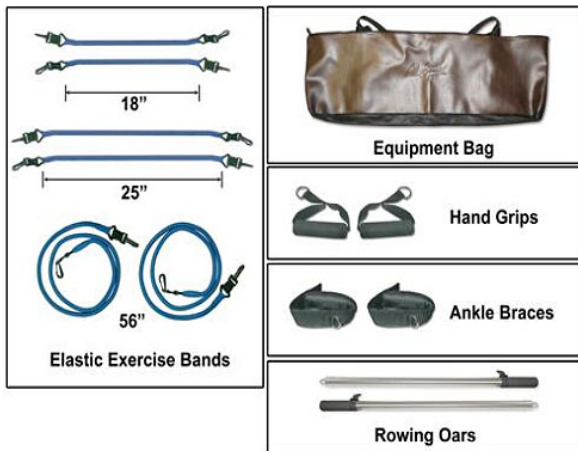

#### Exercise Kit Attachment Plate

EXC11000065



### Cover Lock and Keys



ACC01800026

### Replacement Cabinet Panels

The complete selection of replacement cabinets for all models is very extensive and too lengthy for this owner's manual. To order replacement panels for your spa, visit [www.quickspaparts.com](http://www.quickspaparts.com).

### Covers

All spa covers are designed with a tapered height, angling downward from the center to the sides to drive off rain and prevent water from pooling. The covers listed below are filled with either 1 lb, 1.5 lb, or 2.0 lb foam.

#### Deluxe

5" - 3"  
2.0 Lb. foam

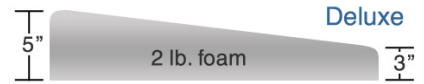

#### 93" x 141"

Fits spa models: F-1222

COV93141DBK-3 Deluxe Taper Black  
COV93141DDB-3 Deluxe Taper Dark Brown  
COV93141DG-3 Deluxe Taper Gray

#### 93" x 171"

Fits spa models: F-1420, F-1437

COV93171DBK-3 Deluxe Taper Black  
COV93171DDB-3 Deluxe Taper Dark Brown  
COV93171DG-3 Deluxe Taper Gray

#### 93" x 200"

Fits spa models: F-1640, F-1770

COV93200DBK-3 Deluxe Taper Black  
COV93200DDB-3 Deluxe Taper Dark Brown  
COV93200DG-3 Deluxe Taper Gray

#### 93" x 210"

Fits spa model F-1896DL

COV93210DBK-3 Deluxe Taper Black  
COV93210DDB-3 Deluxe Taper Dark Brown  
COV93210DG-3 Deluxe Taper Gray

#### 93" x 151"

Fits spa model F-1335

COV93151DBK-3 Deluxe Taper Black  
COV93151DDB-3 Deluxe Taper Dark Brown  
COV93151DG-3 Deluxe Taper Gray

# Basic Troubleshooting

The troubleshooting guidance provided here is intended to cover the most common problems a spa owner may encounter. For more in-depth troubleshooting, go to [www.calspas.com/troubleshooting](http://www.calspas.com/troubleshooting).

Symptom	Possible Solutions
---------	--------------------

**Problems starting up**

Pump won't prime	See priming instructions on pages 10 and 11.
Breaker keeps shutting off	Reset the GFCI breaker. If this continues, contact your dealer or a qualified spa technician.

**Power and system problems**

System won't start up or breaker keeps shutting off	Power may be shut off. Turn on GFCI circuit breaker. If this continues, contact your dealer or a qualified spa technician.
Control panel doesn't respond	Turn on or reset the GFCI circuit breaker. If this does not solve the problem, contact your dealer or a qualified spa technician.  If you hear the pump running but the control panel doesn't respond, contact your dealer.
Spa does not turn off	Spa may be trying to heat up.  In cold climates, if spa is not equipped with full foam or any kind of insulation, it will try to maintain the set temperature. Set the spa to low temperature range and set the temperature to 80°F.  Spa may be in filter cycle. If it is, this is normal and no adjustment is necessary.
Message on the control panel	There may be a problem. See Error Screens on page 16.

**Heat problems**

Spa water does not get hot	Spa may be in low temperature range. Set the spa to high temperature range.  The filter may be dirty or may need to be replaced. Clean or replace the filter.  The water level may be too low. Fill the spa with water level at 4 to 6 inches from the top.  The temperature is not turned up high enough. Raise temperature on topside control.  Cover the spa. The cover will keep heat in the spa and help keep heat from escaping. Make sure cover is on at all times when spa is not in use.  The heater element may be old, deteriorated, coated with scale, or defective. Contact your dealer for more assistance.  The gate valves may be partially or completely closed. NEVER OPERATE YOUR SPA WITH THE GATE VALVES CLOSED!
Spa overheats - temperature greater than 110°F / 43°C	Overheating can occur during summer months and may not necessarily indicate a malfunction. When it occurs, a message code may also appear on the control panel.  Temperature may be set too high. Turn the set temperature down to a lower temperature.  Filtration time may be too long. Turn the filtration cycles down during the warm months.  The spa may not be properly ventilated. Make sure the front of the spa is not blocked to allow air flow.  High speed pumps may have been running too long. Limit pump running time to no more than 15 to 30 minutes.

**Water pressure problems**

Low water pressure	Jet valves may be partially or fully closed. Open the jet valves.  Filter cartridge may be dirty. Clean or replace the filter.  Pump may have airlock. Remove airlock by priming spa (pages 10 and 11).  The suction fittings may be blocked. Remove any debris that may be blocking them.  The filter skimmer may be blocked. Remove the blockage.  Gate valves may be closed. Open gate valves. Note: Never operate your spa with the gate valves closed!
--------------------	---

Please visit [www.quickspaparts.com](http://www.quickspaparts.com) to order your replacement parts.

Symptom	Possible Solutions
No water pressure (no water stream from any jets)	Power may be switched off. Turn the power back on. The pump may be defective. After you have tried all other troubleshooting, contact your dealer for assistance.
Jets surge on and off	Water level may be too low. Add water to normal level.
<b>Pump problems</b>	
Pump runs constantly – will not shut off	There may be a problem with circuit board. Contact your dealer.
Noisy pump	The water level may be too low. Fill the spa with water level at 4 to 6 inches from the top. Filter cartridge may be dirty. Clean or replace the filter. Pump may have airlock. Remove airlock by priming spa (pages 10 and 11). The suction fittings may be blocked. Remove any debris that may be blocking the suction fittings. Gate valves may be closed. Open gate valves. Note: Never operate your spa with the gate valves closed! Air may be leaking into the suction line. Contact your dealer for assistance. Debris may be inside the pump. Contact your dealer for assistance. Noise may be a sign of damage. Contact your dealer for service.
Pump turns off during operation	Automatic timer may have completed its cycle. Press JET 1 or JET 2 button to start the cycle again. Pump may have overheated due to the vents on the equipment door being blocked. Make sure the front of the spa is not blocked to allow air flow. The pump motor may be defective. Contact your dealer for assistance.
Pump has a burning smell while running	A burning smell may be a sign of damage. Contact your dealer for service.
Pump does not run	Pump may have over heated. Let it cool for an hour and try operating the spa for a shorter time. Power to the spa may be shut off. Turn on or reset the GFCI circuit breaker. If this does not solve the problem, contact your dealer or a qualified spa technician.

## “Thermal Creep”

Cal Spas are designed with energy-efficient components and systems that are meant to sustain heat generated by the equipment, which is then cycled back into the spa water. In hot weather or in situations where the spa is set to extended run times, Thermal Creep may occur. Thermal Creep is a condition where the measured water temperature can be higher than the set temperature. To manage Thermal Creep you may:

**Vent your cover.** This means placing a folded cloth about ¾” (2cm) thick under all four corners of the cover before you lock the cover down.

**Open your cover.** Opening the cover at night will also quickly cool the water down if desired.

**Open all air controls.** Set your filtration cycles to run during the cooler times of the day or night.

**Reduce the length of your filter cycles.**

**Visit your local dealer for additional guidance.**

Since Thermal Creep only occurs in well-insulated hot tubs, it is not indicative of something that is wrong with your spa or its equipment.

# LIMITED WARRANTY

This Limited Warranty is extended to the original purchaser of a Cal Spa brand portable spa manufactured after January 1, 2020 and installed for residential use in the United States of America and Canada. This warranty begins on the date of delivery of the spa, but in no event later than one year from the date of manufacture.

### Shell Structural

Warranted against water loss due to defects in the spa shell. 10 years

### Shell Finish

Warranted against blistering, cracking, or delaminating of the interior surface of the spa shell. 7 years

### Equipment and Controls

Electrical equipment components – specifically limited to the pumps, standard titanium heater, and control system – are warranted against malfunctions due to defects in workmanship or materials. 5 years

### Plumbing

Warranted against leaks due to defects in workmanship or materials. 5 years

### Cabinet - synthetic or fiberglass

Warranted against defects in workmanship or materials. Normal wear and weathering of the finish will occur naturally over time and are not defects. 5 years

### Warranties for Other Components

The fuses, headrests, cabinet finish, cal grip, labels, and filters are warranted to be free of defects in workmanship and material at the time of delivery. The factory installed water purification system is warranted against malfunction due to defects in workmanship or material for one year from the original date of delivery. All stereo-related components (receiver, speakers, sub-woofer, stereo media locker, power supply, wireless remote control etc.) are warranted against malfunction due to defects in workmanship or material for one year from the original date of delivery. All other factory-installed components not mentioned specifically, including, but not limited to the wood frame, jets, diverter valves, LED lighting systems, filter lids, and mechanical components, are warranted against malfunction due to defects in workmanship and material for two years from the original date of delivery. The insulating spa cover delivered with the fitness spa is warranted to be free from defects in workmanship and material for one year.

### Genuine Cal Spas Parts & Accessories

This Limited Warranty is void if Cal Spas (the "Manufacturer") or its designated representative determines that the spa has been subjected to damage or failure due to installation of aftermarket parts that are not genuine Cal Spas branded parts and accessories. This disclaimer includes, but is not limited to filters, ozone systems, salt systems, repair parts and other accessories. Genuine Cal Spas brand parts and accessories are built to our highest standards of quality, durability and performance, and they are designed to work with your spa to ensure optimal performance and function.

### Performance

This warranty begins on the date of delivery of the spa, but in no event later than one year from the date of manufacture.

To obtain service in the event of a defect covered by this Limited Warranty, notify your Cal Spa dealer or Cal Spas as soon as possible and use all reasonable means to protect the spa from further damage. Upon proof of purchase, a designated service representative will correct the defect subject to the terms and conditions contained in this Limited Warranty. There will be no charge for parts or labor to repair the defect, although providing access to affect the repair is your responsibility as the spa owner. Freight charges for replacement parts is the responsibility of the spa owner. You may be assessed reasonable repairman travel mileage charges.

In the event that the spa is removed to a repair facility for repair and reinstalled, the cost of removal and reinstallation will be your responsibility as the spa owner. If the Manufacturer determines that repair of the

covered defect is not feasible, it reserves the right to provide a replacement spa of equal value to the original purchase price. In such an event, reasonable costs for removal of the original spa, shipping costs from the factory for the replacement spa and delivery and installation of the replacement will be your responsibility as the spa owner. The replacement spa will carry the balance of the original spa's warranty. Spa covers are not included.

This warranty ends either by specified time frame, owner-transfer, relocation, or installation of any component other than by manufacturer.

### **Warranty Limitations**

This Limited Warranty is void if Cal Spas or its designated representative determines that the spa has been subjected to alteration, neglect, misuse or abuse, or freight damage caused by the common carrier; any repairs have been attempted by anyone other than a designated representative; the failure is caused by accident, acts of God or other causes beyond the control of the Manufacturer; neglect, misuse and abuse include any installation, operation or maintenance of the spa other than in accordance with the instructions contained in the owner's manual provided with the spa, including but not limited to the failure to maintain proper water chemistry and chemical balance and the use of abrasive or improper cleaners or non-genuine parts and accessories. This Limited Warranty does not provide coverage for any item attached to or installed on the spa after the date of manufacture or for gaining access to any component for repair or replacement. Spa units in commercial use are excluded from any coverage whatsoever. The spa owner accepts liability for repair work performed by anyone other than the Manufacturer or a designated Cal Spa representative. This Limited Warranty is void if damage occurs to the spa shell because of excessive heat buildup due to failure to cover a spa that is empty of water while exposed to direct sunlight.

### **Proration of Warranty**

Units determined by the Company to be non-repairable will be replaced on a prorated basis with the same or a comparable unit. The user will be charged one percent of the current retail cost for each full month of ownership from the date of purchase through the date failure is determined to be non-repairable. This charge will be waived during the first twelve months of ownership.

### **Limitations**

The Manufacturer disclaims all warranties, expressed or implied, in fact or in law, to the extent allowed by your State's Law, including the warranty of merchantability and fitness for use, except as stated specifically herein. All warranty service must be performed by the Manufacturer or its designated representative using authorized Cal Spa parts. No agent, dealer, distributor, service company or other party is authorized to change, modify or extend the terms of this limited warranty in any manner whatsoever. The Manufacturer will not be responsible for any statements or representations made in any form that go beyond, are broader than, or are inconsistent with any authorized literature or specifications furnished by Cal Spas.

### **Disclaimers**

The Manufacturer and its representatives shall not be liable for any injury, loss, cost or other damage, whether incidental or consequential, arising out of any defect covered by this limited warranty, including without limitation, loss of use of the spa and cost for removal of defective product even if the Manufacturer was advised of the possibility of damage. The liability of the Manufacturer under this limited warranty, if any, shall not exceed the original amount paid for the defective product. Coverage under this limited warranty shall commence as of the original date of delivery and the duration of such coverage shall not extend for any reason whatsoever beyond the stated time periods. These disclaimers shall be equally applicable to any service provided by the Manufacturer and its designated representatives.

### **Legal Rights**

This Limited Warranty gives you specific legal rights. You may also have other rights that vary from state to state. Some states do not allow limitations on how long an implied warranty lasts, so this limitation may not apply to you.









### Locating the product serial number

The serial number of your spa is located on a metal plate attached to the inside of the door for the equipment area. You will need this number to properly register your spa and activate coverage. Write this information in the space provided below.

Spa Model: \_\_\_\_\_

Spa Serial Number: \_\_\_\_\_

Date Purchased: \_\_\_\_\_

Date Installed: \_\_\_\_\_

Dealer's Phone Number: \_\_\_\_\_

Dealer's Address: \_\_\_\_\_

It is important that you register your Cal Spas product as soon as possible. By taking just a few quick minutes to register, you can enjoy product alerts, more efficient support, and quicker service. Go to <https://calspas.com/register-your-spa.php>. Fill in your information and click "SEND WARRANTY INFO"

Please write a review to let us know how you feel about your spa. To post your review, go to [www.calspas.com](http://www.calspas.com).

**Enjoy your new Cal Spas hydrotherapy experience. Cal Spas would like to ask you to leave us a 5 star review. Thank you!**



email [press@calspas.com](mailto:press@calspas.com) and let us know you left a review!

