

# CalSpas®

## OWNER'S MANUAL

SPECIAL EDITION - LES

2020



© 2020 LMS



[www.calspas.com](http://www.calspas.com)

# Table of Contents

<b>Important Safety Instructions . . . . .</b>	<b>1</b>	<b>Generic Names for Chemicals . . . . .</b>	<b>32</b>
<b>Preparing for Your New Portable Spa . 2</b>		<b>Common Water Chemistry Questions . . . .</b>	<b>33</b>
<b>Pre-Delivery Checklist . . . . .</b>	<b>2</b>	<b>Do's and Don'ts . . . . .</b>	<b>34</b>
<b>Planning the Best Location . . . . .</b>	<b>2</b>	<b>Bather Load . . . . .</b>	<b>35</b>
<b>Clearance for Service Access . . . . .</b>	<b>3</b>	<b>Ozonator . . . . .</b>	<b>35</b>
<b>Preparing a Good Foundation . . . . .</b>	<b>3</b>	<b>Troubleshooting Water Clarity Problems . .</b>	<b>36</b>
<b>Opening the Front Door Panel for</b>		<b>Cleaning and Maintenance and Sound</b>	
<b>Electrical Hookup . . . . .</b>	<b>4</b>	<b>System . . . . .</b>	<b>37</b>
<b>240 Volt Electrical Installation . . . . .</b>	<b>5</b>	<b>Removing and Reseating the Pillows . . . .</b>	<b>37</b>
<b>Wiring Requirement . . . . .</b>	<b>5</b>	<b>Jet Removal and Replacement . . . . .</b>	<b>37</b>
<b>GFCI Wiring Diagram (NEO) for US &amp;</b>		<b>Draining Your Portable Spa . . . . .</b>	<b>38</b>
<b>Canada . . . . .</b>	<b>6</b>	<b>Winterizing (Cold Climate Draining) . . . .</b>	<b>39</b>
<b>120 Volt Electrical Installation . . . . .</b>	<b>7</b>	<b>Cleaning and Replacing the Filter . . . . .</b>	<b>39</b>
<b>Testing the 240 Volt GFCI Breaker . . . . .</b>	<b>7</b>	<b>Spa Cover and Locking System</b>	
<b>Filling and Powering Up Your Portable</b>		<b>Installation . . . . .</b>	<b>39</b>
<b>Spa . . . . .</b>	<b>7</b>	<b>Vacation Care . . . . .</b>	<b>41</b>
<b>Priming the Pump . . . . .</b>	<b>10</b>	<b>Cleaning Your Spa . . . . .</b>	<b>41</b>
<b>Operating Your Spa . . . . .</b>	<b>11</b>	<b>Using the Freedom Sound System . . . . .</b>	<b>41</b>
<b>Primary Navigation &amp; Functions of NEO</b>		<b>Appendix . . . . .</b>	<b>42</b>
<b>One &amp; Two-pump Systems . . . . .</b>	<b>11</b>	<b>Replacement Parts . . . . .</b>	<b>42</b>
<b>NEO Settings for Cold Climates . . . . .</b>	<b>20</b>	<b>Basic Troubleshooting . . . . .</b>	<b>48</b>
<b>Jets . . . . .</b>	<b>23</b>	<b>"Thermal Creep" . . . . .</b>	<b>50</b>
<b>LED Lighting . . . . .</b>	<b>24</b>	<b>Limited Warranty . . . . .</b>	<b>51</b>
<b>Diverter Knobs . . . . .</b>	<b>25</b>	<b>Warranty Registration . . . . .</b>	<b>58</b>
<b>Air Venturis . . . . .</b>	<b>25</b>		
<b>Waterfalls . . . . .</b>	<b>25</b>		
<b>Hydro Streamer Waterfall . . . . .</b>	<b>25</b>		
<b>Water Clarity . . . . .</b>	<b>26</b>		
<b>Water Quality Terms and Definitions . . . .</b>	<b>26</b>		
<b>Water Testing Methods . . . . .</b>	<b>27</b>		
<b>Adding Chemicals to the Spa Water . . . . .</b>	<b>28</b>		
<b>1. Balancing the Water Chemistry Levels . 28</b>			
<b>2. Sanitation and Shock . . . . .</b>	<b>30</b>		
<b>3. Filtration . . . . .</b>	<b>31</b>		
<b>4. Regularity (Maintenance Schedule) . . . .</b>	<b>32</b>		

Copyright 2020 LMS. All rights reserved. Duplication without written consent is strictly prohibited.

Cal Spas® and Freedom Sound System™ are registered trademarks.

Due to continuous improvement programs, all models, operation, and/or specifications are subject to change without prior notice.

LTR20201163, Rev. Z7  
4/26/21

## CONTACT INFORMATION

For customer service, please contact your authorized dealer immediately. If you need additional information and/or assistance, contact:

**LMS Customer Service Department**  
**1462 East Ninth Street**  
**Pomona, CA 91766.**

Toll Free: 1-800-CAL-SPAS  
Fax: 1-909-629-3890

# Important Safety Instructions

## READ AND FOLLOW ALL INSTRUCTIONS.

### DANGER -- Risk of accidental drowning:

Do not allow children to be in or around a spa unless a responsible adult supervises them. Keep the spa cover on and locked when not in use. See instructions enclosed with your cover for locking procedures.

### DANGER -- Risk of injury:

The suction fittings in this spa are sized to match the specific water flow created by the pump. Should the need arise to replace the suction fittings, or the pump, be sure the flow rates are compatible.

Never operate the spa if the suction fitting or filter baskets are broken or missing. Never replace a suction fitting with one that is rated less than the flow rate marked on the original suction fitting.

### DANGER -- Risk of electric shock:

Install the spa at least 5 feet (1.5 meters) from all metal surfaces. As an alternative, a spa may be installed within 5 feet of metal surfaces if each metal surface is permanently bonded by a minimum #8 AWG solid copper conductor to the outside of the spa's control box.

Do not permit any external electrical appliances, such as lights, telephones, radios, televisions, and etc., within five feet (1.5 meters) of the spa. Never attempt to operate any electrical device from inside the spa.

Replace a damaged power cord immediately.

Do not bury the power cord.

Connect to a grounded, grounding-type receptacle only.

### WARNING -- To reduce the risk of injury:

The spa water should never exceed 104°F (40°C). Water temperatures between 100°F (38°C) and 104°F (40°C) are considered safe for a healthy adult. Lower water temperatures are recommended for young children and when spa use exceeds 10 minutes.

High water temperatures have a high potential for causing fetal damage during pregnancy. Women who are pregnant, or who think they are pregnant, should always check with their physician prior to spa usage.

The use of alcohol, drugs or medication before or during

spa use may lead to unconsciousness, with the possibility of drowning.

Persons suffering from obesity, a medical history of heart disease, low or high blood pressure, circulatory system problems or diabetes should consult a physician before using the spa.

Persons using medications should consult a physician before using the spa since some medications may induce drowsiness while others may affect heart rate, blood pressure and circulation.

### HYPERTHERMIA DANGER:

Prolonged exposure to hot air or water can induce hyperthermia. Hyperthermia occurs when the internal temperature of the body reaches a level 3°F to 6°F above the normal body temperature of 98.6°F (or 2°C to 4°C above 37°C). While hyperthermia has many health benefits, it is important not to allow your body's core temperature to rise above 103°F (39.5°C).

Symptoms of excessive hyperthermia include dizziness, lethargy, drowsiness and fainting. The effects of excessive

hyperthermia may include:

- Failure to perceive heat
- Failure to recognize the need to exit spa or hot tub
- Unawareness of impending hazard
- Fetal damage in pregnant women
- Physical inability to exit the spa
- Unconsciousness

**WARNING:** The use of alcohol, drugs, or medication can greatly increase the risk of fatal hyperthermia.

**WARNING:** People with infectious diseases should not use a spa or hot tub.

**WARNING:** To avoid injury, exercise care when entering or exiting the spa or hot tub.

**WARNING:** Do not use drugs or alcohol before or during the use of a spa or hot tub to avoid unconsciousness and

possible drowning.

**WARNING:** Do not use a spa or hot tub immediately following strenuous exercise.

**WARNING:** Prolonged immersion in a spa or hot tub may be injurious to your health.

**CAUTION:** Maintain water chemistry in accordance with manufacturer's instructions.



# Preparing for Your New Portable Spa

## Pre-Delivery Checklist

Most cities and counties require permits for exterior construction and electrical circuits. In addition, some communities have codes requiring residential barriers such as fencing and/or self-closing gates on property to prevent unsupervised access to the property by children. Your dealer can provide information on which permits may be required and how to obtain them prior to the delivery of your spa.

Before Delivery	
	Plan your delivery route
	Choose a suitable location for the spa
	Lay a 5 - 8 cm concrete slab
	Install dedicated electrical supply
After Delivery	
	Place spa on slab
	Connect electrical components

## Planning the Best Location

### Safety First

Do not place your spa within 10 feet (3 m) of overhead power lines.

### Consider How You Will Use Your Spa

How you intend to use your spa will help you determine where you should position it. For example, will you use your spa for recreational or therapeutic purposes? If your spa is mainly used for family recreation, be sure to leave plenty of room around it for activity. If you will use it for relaxation and therapy, you will probably want to create a specific mood around it.

### Plan for Your Environment

If you live in a region where it snows in the winter or rains frequently, place the spa near a house entry. By doing this, you will have a place to change clothes and not be uncomfortable.

### Consider Your Privacy

In a cold-weather climate, bare trees won't provide much privacy. Think of your spa's surroundings during all seasons to determine your best privacy options. Consider the view of your neighbors as well when you plan the location of your spa.

### Provide a View with Your Spa

Think about the direction you will be facing when sitting in your spa. Do you have a special landscaped area in your yard that you find enjoyable? Perhaps there is an area that catches a soothing breeze during the day or a lovely sunset in the evening.

### Keep Your Spa Clean

In planning your spa's location, consider a location where the path to and from the house can be kept clean and free of debris.

Prevent dirt and contaminants from being tracked into your spa by placing a foot mat at the spa's entrance where the bathers can clean their feet before entering your spa.

### Allow for Service Access

Make sure the spa is positioned so that access to the equipment compartment and all side panels will not be blocked.

Many people choose to install a decorative structure around their spa. If you are installing your spa with any type of structure on the outside, such as a gazebo, remember to allow access for service. It is always best to design special installations so that the spa can still be moved, or lifted off the ground.



## Clearance for Service Access

While you are planning where to locate your spa, you need to determine how much access you will need for service.

All spa models require a minimum of three feet / one meter access to all sides of the spa for potential service. For this reason, the spa should never be placed in a manner where any side is permanently blocked. Examples include placing the spa against a building, structural posts or columns, or a fence.

Spa models require access to all sides in case they need service or repair. See the figure below.

If you are planning to enclose or surround your spa with a deck, make sure there is easy access for service or repair.

**Spas require clearance on all sides of the spa.**

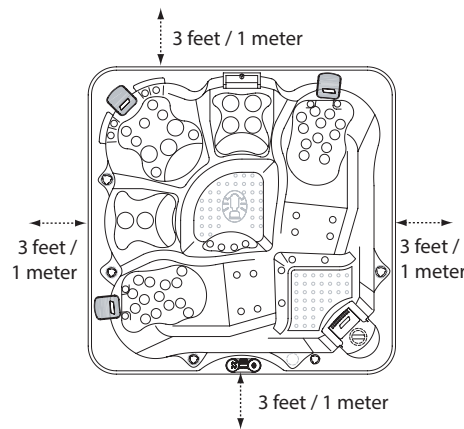

## Preparing a Good Foundation

Your spa needs a solid and level foundation. The area that it sits on must be able to support the weight of the spa, with water and the occupants who use it. If the foundation is inadequate, it may shift or settle after the spa is in place, causing stress that could **DAMAGE YOUR SPA SHELL AND FINISH**.

**Damage caused by inadequate or improper foundation support is not covered by the warranty. It is the responsibility of the spa owner to provide a proper foundation for the spa.**

Place the spa on an elevated 3 to 4" / 30 cm concrete slab. Pavers, gravel, brick, sand, timbers or dirt foundations are **not** adequate to support the spa.

We strongly recommend that a qualified, licensed contractor prepare the foundation for your spa.

If you are installing the spa indoors, pay close attention to the flooring beneath it. Choose flooring that will not be damaged or stained.

If you are installing your spa on an elevated wood deck or other structure, it is highly recommended that you consult a structural engineer or contractor to ensure the structure will support the weight of 150 pounds per square foot (732 kg / m<sup>2</sup>).

To properly identify the weight of your new spa when full, remember water weighs 8.33 lbs. per gallon, or 1 kg per liter. For example, an average 8' spa holds approximately 500 gallons, or 1892 liters, of water. Using this formula, you will find that the weight of the water alone is 4,165 lbs, or 1892 kg. Combined with the dry weight of the spa you will note that this spa will weigh approximately 5,000 lbs, or 2267 kg, when full of water.



## Opening the Front Door Panel for Electrical Hookup

The following electrical connections must be performed by a licensed electrical contractor. Unscrew and remove the two corner panels on each side of the spa's front door.



Reach in and pull the drain assembly through by a few inches. Carefully unscrew the black outer drain knob and then unscrew and remove the front door panel.

Pictured to the right is the inside of the spa behind the front door. The electrician now has access to connect the spa for power. While the front door is off, refer to page 7 for instructions on ensuring the plumbing fittings are secure (but do not be tempted to over-torque or over-tighten these fittings).



Pull the drain pipe through the front door panel, reattach the black outer drain knob and pull the drain assembly back inside so that the knob is flush with the panel again. Reattach and screw panels back in. (Front door first, then corner panels)



## 240 Volt Electrical Installation

All 240V spas must be permanently connected (hard wired) to the power supply. See the GFCI and wiring requirements on page 6.

**These instructions describe the only acceptable electrical wiring procedure. Spas wired in any other way will void your warranty and may result in serious injury.**

When installed in the United States, the electrical wiring of this spa must meet the requirements of NEC 70 and any applicable local, state, and federal codes.

**The electrical circuit must be installed by an electrical contractor and approved by a local building or electrical inspector.**

**Failure to comply with state and local codes may result in fire or personal injury and will be the sole responsibility of the spa owner.**

The power supplied to the spa must be on a dedicated GFCI protected circuit as required by NEC 70 with no other appliances or lights sharing the power.

Use copper wire with THHN insulation. Do not use aluminum wire.

Use the table below to determine your GFCI and wiring requirements.

Wires that run over 100 feet must increase wire gauge to the next lower number. For example: A normal 50 amp GFCI with four #6 AWG copper wires that run over 100 feet would require you to go to four #4 AWG copper wires.

## Wiring Requirement

Control System	GFCI Required	Wires Required
NEO 1500/NEO 2100	One 50 amp GFCI	Four #6 AWG copper wires



# GFCI Wiring Diagram (NEO) for US & Canada

Control System	GFCI Required	Wires Required
NEO 1500/NEO 2100	One 50 amp GFCI	Four #6 AWG copper wires

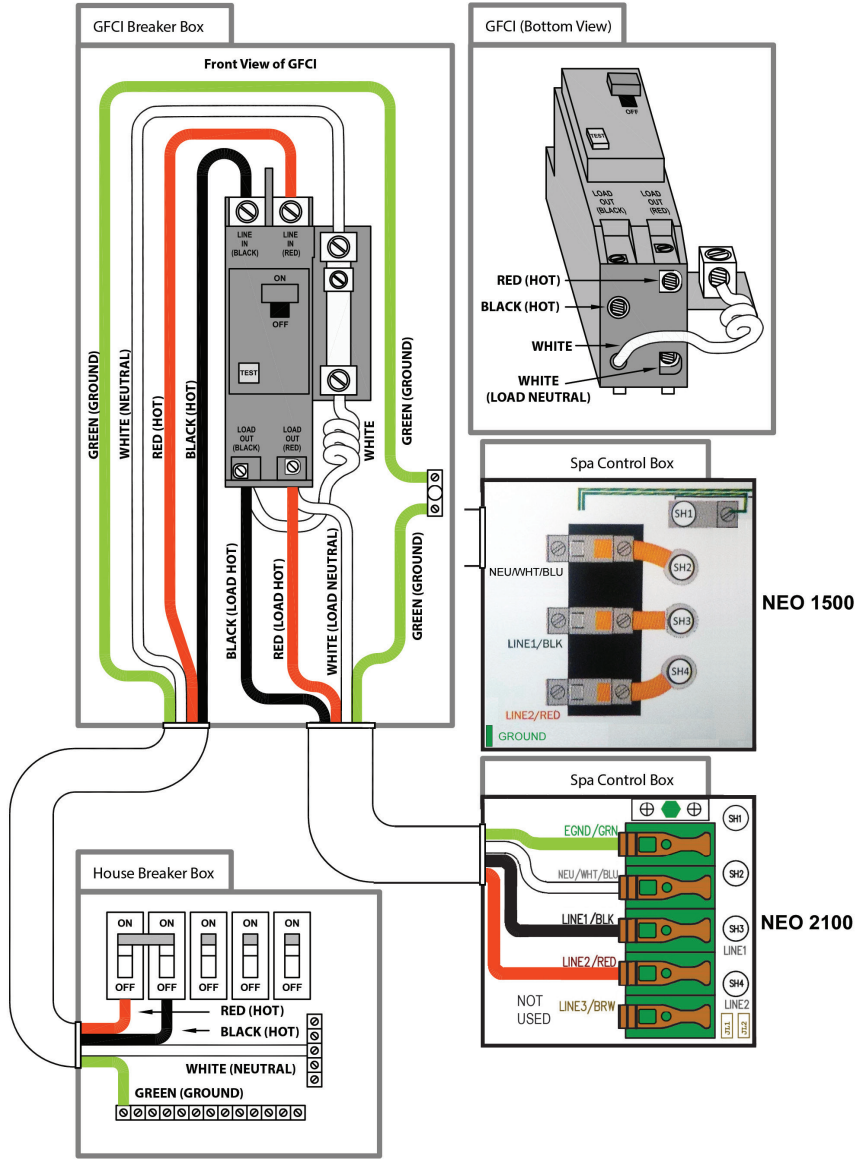

See the Cal Spas Pre-Delivery Guide for more information on spa placement for service access and electrical service.  
[www.calspas.com/manuals](http://www.calspas.com/manuals)

## 120 Volt Electrical Installation

Always follow applicable local, state and federal codes and guidelines.

Use only a dedicated electrical line with a 15 amp breaker.

Cord-and-plug connections may not use a cord longer than 15 feet (4.6 m) and must be plugged into a dedicated 15 amp GFCI connection (NEC 680.42(A) (2)). Do not use extension cords!

Always use a weatherproof-covered receptacle.

Receptacle shall be located not less than 5 feet (1.5 m) from and not exceeding 10 feet (3.0 m) from the inside wall of the spa. (NEC 680.43(A))

Do not bury the power cord. If your cord becomes damaged, replace it before next usage.

All 120V spas must have a GFCI. This can be either a 15 amp GFCI receptacle or a 15 amp GFCI cord and plug kit as shown (CKIT110 - P/N ELE09700086).

### Testing the GFCI plug

Test the GFCI plug prior to first use and periodically when the spa is powered.

1. Plug in the GFCI into the power outlet. The indicator should turn on.
2. Press the TEST button. The GFCI will trip, the indicator will turn off, and the spa will stop operating.
3. Press the RESET button. The GFCI will reset, the indicator will turn on again, and the spa will turn back on.



The spa is now safe to use.

If the GFCI trips while the spa is in use, press the RESET button. If the GFCI does not reset, unplug the spa and call your local Cal Spas dealer for service. DO NOT USE THE SPA!

## Testing the 240 Volt GFCI Breaker

Test the GFCI breaker prior to first use and periodically when the spa is powered. To test the GFCI breaker follow these instructions (spa should be operating):

1. Press the TEST button on the GFCI. The GFCI will trip and the spa will shut off.
2. Reset the GFCI breaker by switching the breaker to the full OFF position, wait a moment, then turn the breaker back on. The spa should have power again.

## Filling and Powering Up Your Portable Spa

### 1. Inspect the spa equipment.

Inspect all plumbing connections in the equipment area of your spa.

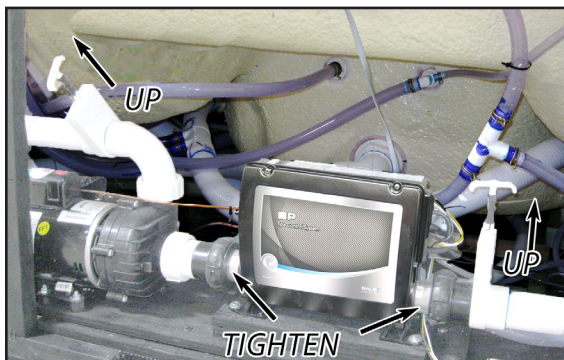

- Make sure unions in the equipment pack are tight. (Be careful not to over-tighten the plumbing fittings.)
- If your spa has gate valves, make sure they are all in the UP or OPEN position.
- Make sure the drain valve is closed and capped. (See page 38 for a description of drain valves.)

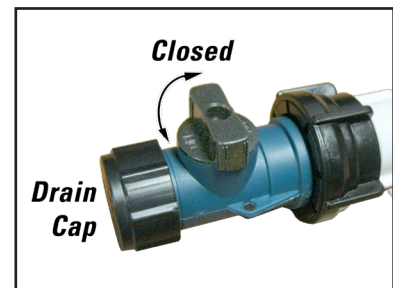

Never run the spa with the gate valves closed or without water circulating for long periods of time.

2. Remove the cartridge from filter canister.

**If you have a skimmer like this:**

Grip the filter by the handle and unscrew it from the canister. Never try to pull the filter cartridge while the spa is running in low or high speed (i.e., any speed).



**If you have a skimmer like this:**

Remove the black skimmer cap and barrel, grip the filter by the handle and unscrew it from the canister.



**Teleweir Mega filter skimmer**

- 75 square feet filtration
- Smooth cap

**If you have a skimmer like this:**

Rotate and remove the black locking ring. Remove the black skimmer cap and barrel, grip the filter by the handle and unscrew it from the canister.

Replace and lock the locking ring and slide the skimmer cap and barrel back in the canister.

**Note:** The skimmer cap and barrel were locked in place at the factory to prevent damage during shipment. It must be unlocked and replaced in the filter canister so that it can float when the spa is filled. If you do not remove the cap and barrel, your spa's filtration system will not perform as it was designed to.



**Teleweir filter skimmer**

- 50 square feet filtration
- Spoked cap



After you remove the filter, remove the plastic wrapper and soak it in water for 30 minutes before you replace it. A dry filter can allow air into the filtration system which can cause the pump to fail to prime.

3. Fill the spa.

Place a garden hose in the filter canister and fill your spa.

**Always fill the spa through the filter canister.** Failure to do so may cause air to be trapped in the filtration system and prevent the pumps from operating properly.



Fill the spa until water level is about six inches from the top.

If the water level is too low or too high, your spa will not operate properly.

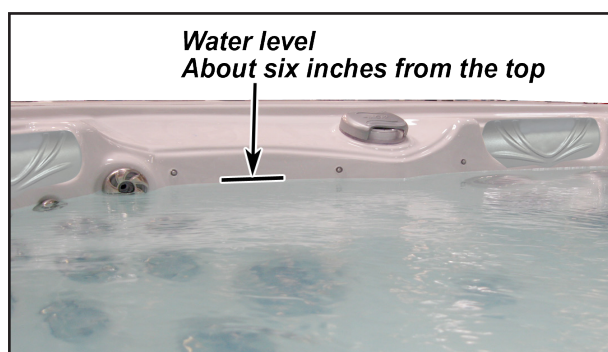

**Never fill your spa with soft water.**

**Soft water** makes it impossible to maintain the proper water chemistry and may cause the water to foam, which will ultimately harm the finish of the spa and void your warranty. You may fill your spa with **well water**



**provided the following conditions are met:** 1) Purchase and use a pre-filter to run the well water through on the fill-up. The pre-filter will be placed before the spa filter in the fill-up flow of water. 2) Have a Total Dissolved Solids (TDS) and metals test performed by a qualified person after the fill-up process but before any spa use.

#### 4. Turn on power to the spa.



When the spa is filled to the correct level, turn on the power at the GFCI breaker. (Ensure that the 120V spas are connected to the proper electrical outlet.)

#### 5. Prime the pump. (NEO system)

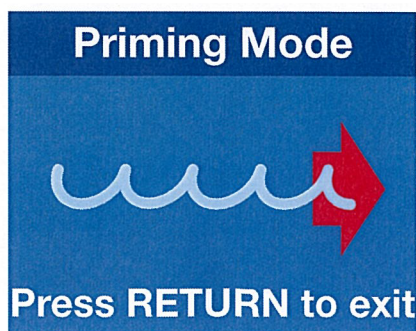

The system will enter the priming mode. **Priming Mode** will display on the control panel. In Priming Mode, all devices such as jets and lights are operable. Jets can be turned on and off to help prime the pump. The system will exit Priming Mode and go to the Main display when the RETURN button is pressed, or after four minutes of inactivity.

#### 6. Install the filter into the filter canister.



Make sure the filter has soaked at least 30 minutes before you install it. Insert the filter all the way and screw it in. Do not over-torque the cartridge during installation, just hand tighten gently.



#### 7. Adjust water chemistry.

Test and adjust the water chemistry. See the section on page 26 for instructions on keeping your water clear.

#### 8. Let the spa heat up.

When the spa has finished priming, the heater will activate. Put the cover on and let the spa heat to the set temperature.

## Priming the Pump

New spa owners often have difficulty the first time they start their spa and the pump fails to prime. This can be frustrating, but these simple instructions can help you.

Sometimes air can become trapped in the pump while filling the spa. You will know this has happened when after you have filled and started the spa, the pump does not seem to function. You will hear the pump operating, but no water will be moving.

There are two methods of priming the pump.

### The first method will remove small air bubbles trapped in the pump.

1. Turn the spa on and wait for PR (Priming Mode) to appear on the topside display.
2. Press the JETS 1 button to turn on the pump and let it run for 10 seconds. The pump should be running in low speed.
3. Press the JETS 1 buttons again and let the pump run in high speed for 10 seconds.
4. Press the JETS 1 button again to turn off the pump. The pump should be left in the off position for 10 to 15 seconds.
5. Repeat steps 1 through 4 until water is flowing through all the jets and all air is removed from the plumbing.

### The second method will remove a large air lock within the pump.

1. Using a Phillips screwdriver, remove the front panel from the spa and locate the pump.
2. While the spa is operating, turn the bleeder valve counter clockwise with a small pair of pliers or a flat head screwdriver until the air has been released from the pump.
3. If this is unsuccessful, loosen the white union nut on side of the pump with channel locks. When air is bled out, tighten the nut and set the pump on high speed.



The pump will not work properly while air is trapped in it. Continuing to operate the pump in this way will cause damage.

Whenever you fill your spa, fill it through the filter canister and make sure all jets are open.

Note: If you press the **Temp** button any time during Priming Mode, it will exit that mode and begin Standard Mode.

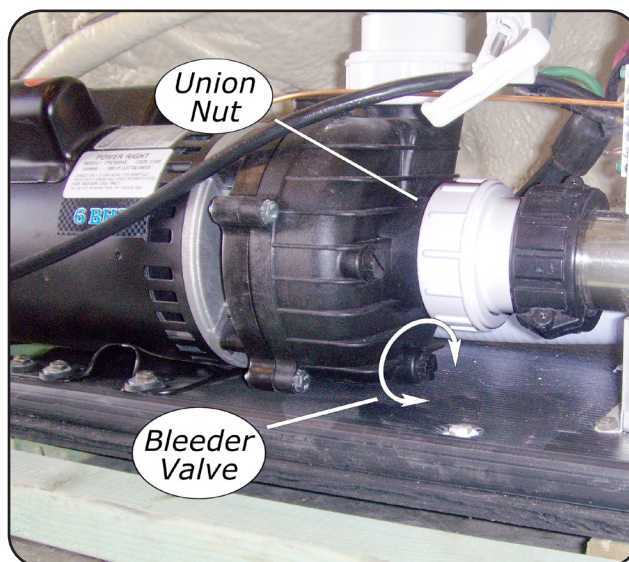

# Operating Your Spa

## Primary Navigation & Functions of NEO One & Two-pump Systems

### 1100 Wave Panel and 1100 Oval Panel



Two-pump system



One-pump system



**MAIN SCREEN:**

The main screen displays current time, water temperature, and status of the system accessories. The screen below from bottom, left to right indicates LIGHT ON, BLOWER ON, JET 1 at low speed.

**PRIMING MODE:**

When power is ON, the system will enter a priming mode with priming screen display on the panel. In this mode, all devices such as JETS, BLOWERS or LIGHT are operable. JETS can be turned on and off to prime the pump. System will exit priming mode and go to MAIN display when RETURN button is pushed, or after 4 minutes of inactivity.

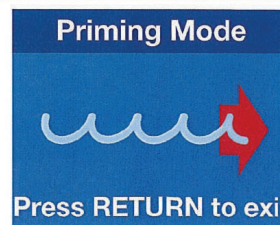
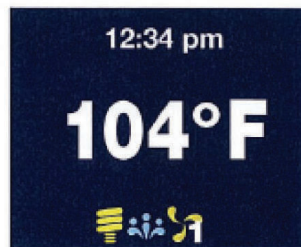



**SPA OPERATION:**

Turn system accessories ON and OFF by pushing appropriate button on the right side of panel (LIGHT, JET 1, BLOWER, JET 2...) These accessories have timeout defaults from the manufacturer and will turn OFF automatically after the time has expired. Timeout time for LIGHT default is 60 minutes; BLOWER default is 15 minutes; JET at low speed default is 60 minutes; and JET at high speed is 15 minutes. User can change these default times in "DEVICE TIMEOUT" setting menu.

**MENU NAVIGATING:**

- MENU button: use to enter setting menu and sub-menu screens. For screens with several settable fields (example: DATE-TIME screen), use MENU button to navigate between different fields within the screen.
- UP and DOWN button: use to navigate between different options or changing values of a field.
- RETURN button: use to confirm the setting and goes back to previous screen.

**SETTING TEMPERATURE:**

To change water set temperature, use UP and DOWN buttons to set the desired temperature. The screen will display "SET TEMP" with the current set temperature. After 5 seconds without any change to the set temperature, the screen will reverse back to MAIN screen with current water temperature display. Changing set temperature will make heat pump turn on to get accurate water temperature to determine if water needs to be heated up.







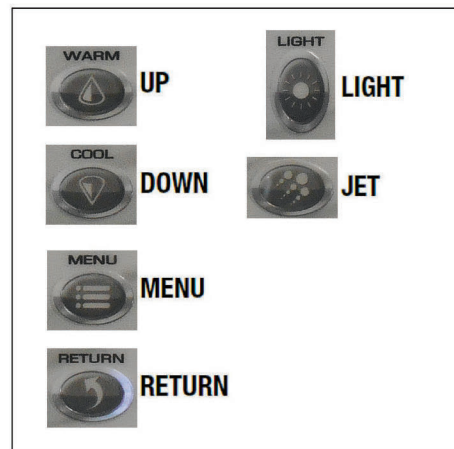













## Control Panel Quick Reference

1. Press **UP** button to set desired temperature. If in a **MENU** mode, then the **UP** to navigate the screen up.
2. Press **DOWN** button to set desired temperature. If in a **MENU** mode, then the **DOWN** to navigate the screen down.
3. Press **MENU** button to get into the **MENU** for setting. Use **UP** or **DOWN** button to navigate, press **MENU** button then **UP** or **DOWN** button to set your desire. Refer to your Instruction Manual for additional details.
4. Press **RETURN** button to activate or back to previous setting.  
**Optional:** The **RETURN** button can be used for **BLOWER, JET** or **AUX**
5. Press **LIGHT** button, the Spa Light turns **ON**, press **LIGHT** button again, the Spa Light turns **OFF**.



*Default Timeout setting:* Spa **LIGHT** is 60 minutes; **BLOWER** is 15 minutes, **JET** at low speed is 60 minutes; and **JET** at high speed is 15 minutes. User can change these default times in **DEVICE TIMEOUT** setting menu.

**SELECTION ICONS:**

-  FILTER CYCLE 1
-  ENERGY SAVING HEAT MODE
-  OZONE ON
-  FILTER CYCLE 2
-  VACATION HEAT MODE
-  JET ON LOW SPEED
-  FILTER CYCLE 3
-  CLEANER CYCLE
-  JET ON HIGH SPEED
-  FILTER CYCLE 4
-  POLLING CYCLE
-  BLOWER ON
-  LIGHT ON
-  TEMPERATURE LOCK
-  SPECIAL TEMP SELECT
-  HEATER ON
-  PANEL LOCK
-  OPTION
-  HEATER START-UP

**PANEL TIMEOUT:**

If user is in Setting Menus and no button is pushed within 15 seconds, the screen will timeout, current screen setting will be lost and panel reverts back to MAIN screen.

In MAIN screen, if no buttons is pushed within 60 minutes, all LED and LCD lights will turn off and panel goes to sleep. Any button pushed in this time will wake the panel up, LED and LCD lights will turn back on and panel will poll for water temperature.

**ENTER SETTING SCREENS:**

Press MENU button to display a list of set up screens.

Use UP and DOWN to navigate between various set up screens.

Press MENU again to enter a particular set up screen or press RETURN to goes back to MAIN screen.

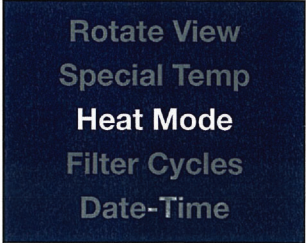
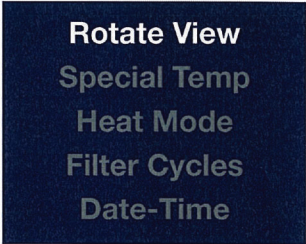

## Settings Screens

- **ROTATE VIEW:** rotate the view 180 degrees, the UP and DOWN buttons also swap when rotated. With ROTATE VIEW highlighted, press MENU to enter ROTATE VIEW setting. Use UP/DOWN to select desired setting and RETURN to exit and confirm the setting.
- **SPECIAL TEMP:** to temporarily heat spa to 105°F or 106°F once, and return to previous temperature setting. With SPECIAL TEMP highlighted, press MENU to enter SPECIAL TEMP setting. Use UP/DOWN to select the desired setting and RETURN to exit and confirm the setting.
- **HEAT MODE:** select STANDARD heating mode for most users or ENERGY SAVING mode (reduces polling for water temperature) or VACATION mode (set temp set to 60°F). With HEAT mode highlighted, press MENU to enter HEAT mode setting. Use UP/DOWN to select the desired setting and RETURN to exit and confirm the setting.
- **FILTER CYCLES:** set up filter cycle START TIME, DURATION and DATE for filtering the spa. For FILTER CYCLE 1 and 2, if DURATION is set to ZERO the system will do a purge cycle at the start time setting. With FILTER CYCLE highlighted, press MENU to enter FILTER CYCLE 1, 2, 3, or 4 setting. Select a FILTER CYCLE and press MENU again to enter TIME/DURATION setting screen. In this screen, press MENU to move between HOURS, MINUTES and DAYS setting; use UP/DOWN to change the values and RETURN to exit and confirm the setting. FILTER CYCLES 3 & 4 default OFF. To select it, enter START TIME, DURATION and enable ALL DAY or specific day for both FILTER CYCLES 3 & 4.
- **DATE-TIME:** set up date and time for the spa. With DATE-TIME highlighted, press MENU to enter DATE-TIME setting. In this screen, pressing MENU will move and highlight various fields that can change the setting; UP/DOWN to change the values and RETURN to exit and confirm the setting.
- **DEGREE F/C:** displays spa temperature in Celsius or Fahrenheit. This option is only available for 60 Hz countries. Unit automatically displays Celsius for 50 Hz. With DEGREE F/C highlighted, press MENU to enter DEGREE F/C setting. Use UP/ DOWN to select the desired setting and RETURN to exit and confirm the setting.
- **TIME DISPLAY:** displays spa time in AM/PM or 24 hours time. With TIME DISPLAY highlighted, press MENU to enter TIME DISPLAY setting. Use UP/DOWN to select the desired setting and RETURN to exit and confirm the setting.
- **DEVICES TIMEOUT:** allows changes to timeout setting for various devices. LIGHT can be set to a maximum of 4 hours; PUMP in high speed and BLOWER can be set to a maximum of 1 hour; and PUMP in low speed can be set to a maximum of 2 hours. With DEVICES TIMEOUT highlighted, press MENU to enter and select various devices setting. Use UP/DOWN to select the desired time setting and RETURN to exit and confirm the setting.
- **PANEL LOCK:** provides a choice to lock out panel buttons.
  - 1) Press MENU
  - 2) Use COOL (also known as Down button) to get to the PANEL LOCK option
  - 3) Press MENU button to select, then scroll down to the MENU option
  - 4) Press RETURN button to confirm this selection
  - 5) Press RETURN button again – to resume to the Temperature screen.

**At this point, the spa user is locked out of changing menu options.**

**To cancel MENU LOCK and resume all spa control functions, perform the following procedure:**











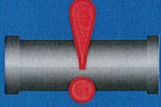

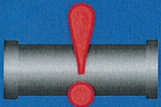
- 1) Turn off the circuit breaker supplying mains power to the SpaPak and wait 10 seconds
- 2) Turn back on the circuit breaker supplying mains power to the SpaPak.
- 3) Wait for the topside to start up.
- 4) When the screen displays, "Priming Mode .... Press Return to exit", **do not press Return; press the Menu button instead.**
- 5) Step through the menu to the Panel Lock entry. (The screen should now show Panel Lock at the top, and Menu Lock highlighted below).
- 6) Press the WARM (also known as Up button) until **Off** is highlighted.
- 7) Press the RETURN button.

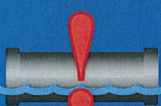
**MENU LOCK is now cancelled.**

- **NO HEAT TIME:** set the time frame for not allowing heater to turn on. With NO HEAT TIME highlighted, press MENU to enter NO HEAT TIME setting. In this screen, pressing MENU will move and highlight various fields that can change the setting; use UP/DOWN to change the values and RETURN to exit and confirm the setting.
- **SERVICE MODE:** *only available for Authorized Dealers and Spa Manufacturer.*
- **DEMO MODE:** to demonstrate all device capabilities of the spa. With DEMO MODE highlighted, press MENU to enter MODE setting. Use UP/DOWN to select the desired setting and RETURN to exit and confirm the setting.
- **GENERAL INFORMATION:** displays general information for the spa. With GENERAL INFORMATION highlighted, press MENU to enter GENERAL INFORMATION menu. Use UP/DOWN to view different pages and information and RETURN to exit the page. Screen will indicate which plug should be inserted to correct side connector.
- **LANGUAGES:** to select various languages for the spa display. With LANGUAGES highlighted, press MENU to enter and select a specific language. Use UP/DOWN to select the desired setting and RETURN to exit and confirm the setting.
- **SERENITY MODE:** set to turn off all outputs and provide quiet while in spa. With SERENITY MODE highlighted, press MENU to enter and select a specific time. Use UP/DOWN to select the desired time setting. Press MENU again to navigate to EXIT/START. Select the desired option and RETURN to exit and confirm the setting.
- **ENERGY INTERVAL:** *only available for Non-Circ systems.* With ENERGY INTERVAL highlighted, press MENU to enter ENERGY INTERVAL setting. Use UP/DOWN to select the desired minutes setting and RETURN to exit and confirm the setting.
- **CLEANER CYCLE:** *only available for Non-Circ systems.* To turn on filtration after using the spa for short cleaning period. With CLEANER CYCLE highlighted, press MENU to enter and select a specific duration. Use UP/DOWN to select the desired time setting. Press Menu again to navigate to Exit/Start. Select the desired option and RETURN to exit and confirm the setting.
- **Reset Wi-Fi:** *only available with Wi-Fi module in the system.* To reset Wi-Fi network setting in Wi-Fi module. With RESET Wi-Fi highlighted, press MENU to enter. Use UP/DOWN to select the desired setting and RETURN to exit and confirm the setting.



# Error Screens

<p><b>Plumbing Error</b></p>  <p>Press RETURN to clear</p>	<p>◀ Error caused when SENSOR 1 and SENSOR 3 have been plugged in incorrectly. Swap the SENSOR 1 and SENSOR 3 plug in controller to correct this problem.</p> <p>Check SENSOR 1 connection. ▶</p>	<p><b>Sensor 1 open</b></p>  <p>Press RETURN to clear</p>
<p><b>Insufficient Flow</b></p>  <p>Press RETURN to clear</p>	<p>◀ Error caused by no water flow through heater or no water in heater. Check to be sure there is enough water flow through heater.</p> <p>Check SENSOR 1 connection or replace SENSOR 1. ▶</p>	<p><b>Sensor 1 short</b></p>  <p>Press RETURN to clear</p>
<p><b>Low Flow</b></p>  <p>Press RETURN to clear</p>	<p>◀ Check to be sure there is enough water flow through heater.</p> <p>Check SENSOR 2 connection. ▶</p>	<p><b>Sensor 2 open</b></p>  <p>Press RETURN to clear</p>
<p><b>Water Overheat</b></p>  <p>Press RETURN to clear</p>	<p>◀ Wait for water temperature to cool down.</p> <p>Check SENSOR 2 connection or replace SENSOR 2. ▶</p>	<p><b>Sensor 2 short</b></p>  <p>Press RETURN to clear</p>
<p><b>Heater Overheat</b></p>  <p>Press RETURN to clear</p>	<p>◀ Wait for water temperature to cool down. Check to be sure there is enough water flow through heater.</p> <p>Check SENSOR 3 connection. ▶</p>	<p><b>Sensor 3 open</b></p>  <p>Press RETURN to clear</p>
<p><b>Potential Freeze</b></p>  <p>Press RETURN to clear</p>	<p>◀ Error caused when SENSOR 1, 2, or 3 detects low temperature. All JETS and BLOWERS will turn on automatically to protect plumbing from freezing. JETS and BLOWERS will shut down when all 3 SENSORS reach a desired temperature.</p> <p>Check SENSOR 3 connection or replace SENSOR 3. ▶</p>	<p><b>Sensor 3 short</b></p>  <p>Press RETURN to clear</p>

## Adjusting Date-Time and Filtration Settings

Shown below is the default topside screen. (Your temperature setting may vary according to your preferences.) In order to access and change the internal clock of your spa, first press MENU.



That action will take you to this screen



Use the COOL (Down arrow) to highlight the Date-Time option (which is now highlighted in white).





Press the MENU button to select the option.



Press the UP-DOWN buttons to increase or decrease the value of each highlighted field.



Press the MENU button to advance to the next field you wish to change.





Press RETURN when you have finished setting date and time to save your chosen settings.



Once the screen has reverted back to temperature, you can now adjust Filter Cycles. **NOTE: You do not necessarily have to adjust the Filter Cycles because the default factory settings give you two Filter Cycles per day automatically.** In any case, to access the Filter Cycles, press the MENU button.



This time select Filter Cycles. (Press the MENU button to access the sub-menus.)





Filter Cycles 1 and 2 are the factory-programmed defaults. These may be satisfactory for your needs, but can be customized if you wish. **If you leave the Filter Cycles option untouched, you will still have Filter Cycles 1 and 2 working for you every day.** Filter Cycles 3 and 4 can also be employed in addition to Filter Cycles 1 and 2 and these Cycles allow full customization as well.



Filter Cycles 1, 2, 3 and 4 can all be adjusted in 15 minute increments. Use the MENU button to move from field to field, use the UP and DOWN arrows to make adjustments and then press RETURN once you're satisfied with your selections for all Cycles. Please note that the system will not allow you to set overlapping or contradictory Cycles.



## NEO Settings for Cold Climates

It may be necessary to adjust some settings of the NEO Spa controller in cold climates. The guidance below will help to make certain you will continue to enjoy your spa despite the change in season.

### Make certain:

**The cover of the spa is securely fastened to the spa when the spa is not in use.**

- Keeping the cover on the spa will conserve heat and energy.

**The 'ENERGY INTERVAL' is set to 15 minutes:**

- Press MENU
- Select 'ENERGY INTERVAL'
- Use WARM/COOL to adjust the interval to 15 minutes.
- Press RETURN to save the setting.

This will make certain the spa checks the temperature of the water every 15 minutes to maintain the Set Temperature.



A video guide can be found here:

<https://www.youtube.com/watch?v=K3I9iOITL-k>

**The system is in 'STANDARD' heat mode:**

- Press MENU
- Press WARM/COOL to select 'HEAT MODE'.
- Press MENU to enter 'HEAT MODE'.
- Press WARM/COOL to select 'STANDARD'.
- Press RETURN to save the setting.



**A temperature higher than 104 degrees (F) may be desired on occasion.**

**'SPECIAL TEMP' can be used for these instances:**

- Press MENU
- Press WARM/COOL to select 'SPECIAL TEMP'.
- Press MENU to enter 'SPECIAL TEMP'.
- Press MENU to enter or RETURN to exit.
- Press WARM/COOL to select '105' or '106'.
- Press RETURN to save the setting.



'Special Temp' will heat the spa one time to the selected temperature. The spa will then maintain the previous 'Set Temperature'.



# Operating the NEO Wi-Fi App

To connect and operate your Smart Device with Waterway Spa Pack WiFi please follow these instructions:

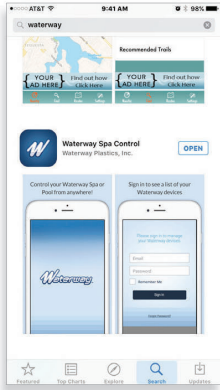

1

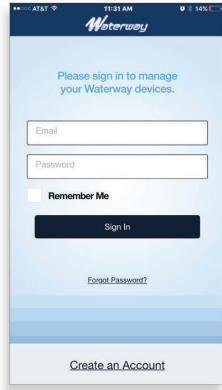

2

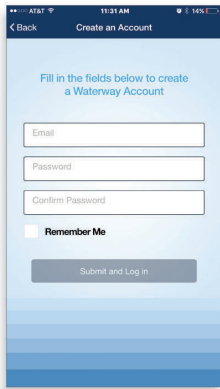

3

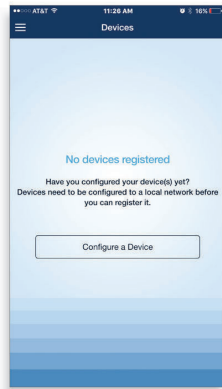

4

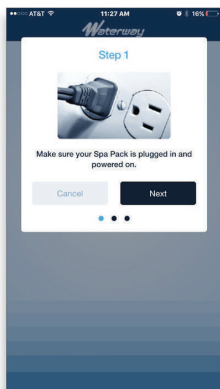

5

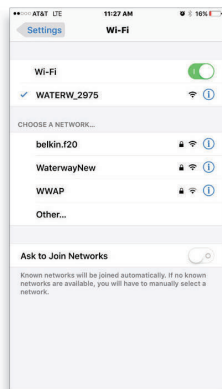

6

1. Download and install the App from App Store or Google Store.
2. Click on Create an Account .
3. Enter your email address, password, confirm and submit.
4. Click on Configure a Device.
5. Make sure your Spa Control pack is powered on and press Next.
6. Go to your phone setting, WiFi, and connect to the Waterway Wi-Fi device temporary network. For example: WATERW-XXXX.

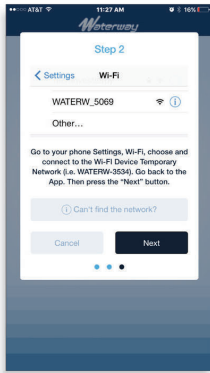

7

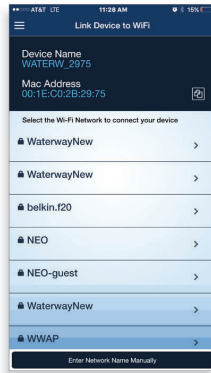

8

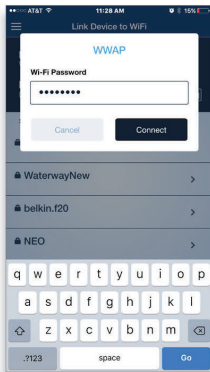

9

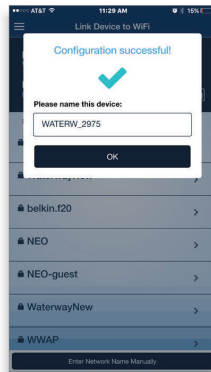

10

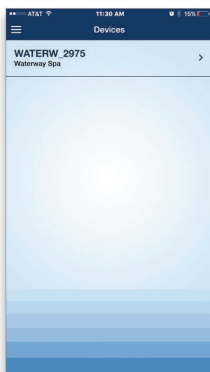

11



12

7. Go back to the App, press Next .
8. Select your home network from the list (If your network name is not on the listed, it can be entered manually).
9. Enter your home network password and press Connect .
10. Then the device will configure and connect to your home WiFi network and the Worldwide Web, Press OK .
11. Click on configured Waterway Wi-Fi device, i.e. WATERW-XXXX .
12. Now you can control your spa from anywhere in the world using your smart phone. You can set the temperature, heating operation mode and turn the light ON/OFF. In order to access the application menu press ON in top left corner.



## Connecting to a Device or Network

### 1 Direct connection

Range: About 20 feet  
Range limit: Limited to the range of the wi-fi module



**HOW TO CONNECT TO IT:**

Install the app on your phone or device -- see the following section "Installing the app".

### 2 Through home network with no internet access

Range: About 50 feet  
Range limit: Limited to the range of your home router's signal



**HOW TO CONNECT TO IT:**

1. Install the app on your phone or device.
2. Exit the app and go to wi-fi settings on your phone or device.
3. Select and enable your local router.
4. Start the app. After you connect, select Settings on the home screen.
5. On the Settings screen, select Advanced, then on the Advanced screen, select Wi-fi Settings.
6. On the Wi-fi screen, select WPA. Then select the name of your home router from the drop-down menu.
7. Enter the SSID and Key for your router, then tap Save and select OK twice.
8. Close the app and re-start it to connect to your home network.

### 3 Through a network with internet access, using Cloud connection or other hotspot connection

**Allows unlimited simultaneous connections**

Range: Worldwide  
Range limit: Limited to 3G / 4G / hotspot availability

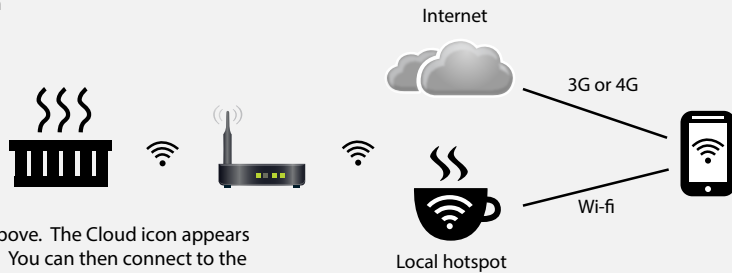

**HOW TO CONNECT TO IT:**

Follow connection instructions from section (2) above. The Cloud icon appears automatically when network connection is made. You can then connect to the spa's wi-fi module.

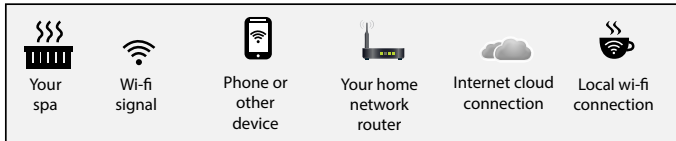

## Jets

Almost all of the jets in your spa are adjustable. Rotating the face of an adjustable jet to the left (counterclockwise) will decrease the amount of water flow through the jet. Rotating the face of an adjustable jet to the right (clockwise) will increase the amount of water flow through the jet. (See example shown here.)

Neck jets adjust in the opposite directions (counterclockwise to increase, clockwise to decrease).





## LED Lighting

Press the LIGHT button on the topside control panel to turn the spa light on. If your spa has perimeter LED lights, they will also light up at the same time as the spa light.

The LEDs operate in three modes:

1. **Cycle:** When you continually press the LIGHT button, the LEDs will cycle through the three main LED colors (Red, Green, and Blue) or combinations of the three that produce the following colors: light green, purple, light blue, yellow, etc.

Each time you press the button, you immediately advance to the next color in sequence or eventually a different light pattern.

2. **Flashing:** When you are cycling through all the colors, the next time you push the LIGHT button, the LED lights may start flashing. This is another normal operational pattern option.

3. **Fading cycle:** The next phase of operation when you push the LIGHT button is a slow and/or fast fade random transition from one color to the next.

- If a spa is equipped with more than 100 points of light, the Slow Fading Cycle will flicker during a color change.
- Every air valve and water valve is equipped with 4 LED points.
- Every jet is equipped with 2 LED points.
- Perimeter LEDs take 9 points of light.
- The waterfall takes 4 points of light.

Spas with exterior corner LED lighting generally work in the same mode as described above. The variations in color and patterns provide you with multiple options to suit almost any lighting preference.

## Diverter Knobs

Diverter knobs are 1" and 2" knobs located around the top of your spa. They allow you to divert water through jets from one side of the spa to the other, or in most cases from floor jets to wall jets. This is accomplished by rotating the diverter knob to the left (counterclockwise), decreasing the amount of water flow through a section of jets. To increase the amount of water flow through the other section of jets, rotate the handle to the right (clockwise).



## Air Venturis

Air venturis are the 1" knobs located around the top of your spa. Each one will let you add a mixture of air with the jet pressure. This is accomplished by rotating the air venturi knob to the left (counterclockwise) to increase the amount of airflow through the jets. To decrease the amount of airflow through the jets, rotate the handle to the right (clockwise).



## Waterfalls

Some spa series include optional waterfalls. When the booster pump is on, rotate the dial on top (for the cascade waterfall) or turn the knob (for the hydro streamer -- see below).



## Hydro Streamer Waterfall

Your spa may include two to eight streamer waterfalls. When the booster pump is on, turn the 1" diverter knob to adjust the rate of flow to the waterfall jets.

The waterfall jet faces are not adjustable. Do not turn the jet faces because you may accidentally remove them.

Always shut off water to the hydro streamer jets before you place the cover on the spa. Water from the hydro streamer jets sprays in an arc that is higher than the top surface of the spa. When water from the hydro streamer jets sprays the bottom of the cover, it will collect and run to the edge of the spa and drip over the top.



# Water Clarity

This section is intended for new spa owners with no experience with water chemistry. Everyone's experience with maintaining water quality is different, but there are some general concepts you need to know.

Water maintenance is not difficult, although it requires regular attention. The most important thing to understand about taking care of your spa water is that preventive action is much easier than correcting water quality issues.

Before you begin, we recommend you become familiar with some water quality terms and their definitions (see next page).

Whether you're filling your spa for the first time (see page 7) or refilling it after draining it for regular maintenance (see page 38), start and maintain your spa water by following the plan we describe in this section.

## 1 Chemical Balance

See page 28 to learn how to balance your spa water.



You will need to test and adjust the chemical balance of your spa water. Although this is not difficult, it needs to be done regularly.

You need to test the level of calcium hardness, total alkalinity, and pH.

Spa owners with a bromine generator also need to check

## 3 frequency and intensity of use.

Spa owners with an ozonator also need to add sanitizer, although their requirements are different.



### Filtration

See page 31 for filter cleaning instructions.

Cleaning your filter regularly is the easiest and most effective single thing you can do to keep your water clear.

A clogged or dirty filter will cause the heater

## 2 total dissolved solids and phosphates.

### Sanitation and Shock



See page 30 to learn how to use sanitizer and shock.

Sanitizers kill bacteria and viruses and keep the water clean. A low sanitizer level will allow microbes to grow quickly in the spa water. We recommend using either chlorine or

bromine as your sanitizer.

You also need to add shock to the water to stimulate the chemical sanitizer. How much you use and how often depend

## 4 and pump to work harder than they need to, possibly causing them to fail.

The spa's heating system will only function with the proper amount of water flow through the system.



### Regularity

See page 32 for the schedule of recommended maintenance.

Clear water requires regular maintenance. Establish a routine based on a regular schedule for your spa water maintenance.

Maintaining your water quality helps the enjoyment of your spa and extends your spa's life by preventing damage from neglect and chemical abuse.

## Water Quality Terms and Definitions

The following chemical terms are used in this section. Understanding their meaning will help you to better understand clear water maintenance. Words in bold type are defined in this table.

### Bromine / Bromamines

Bromine is an efficient sanitizer chemical for spas. When used as a **sanitizer**, bromine forms compounds called bromamines. Bromine can be added to the spa or automatically generated. See page 30 for discussion on **sanitizers**.

Bromamines are compounds formed when bromine combines with nitrogen from body oils, perspiration, etc. Unlike chloramines, bromamines have no pungent odor and are effective **sanitizers**.

### Chlorine / Chloramines

Chlorine is an efficient sanitizing chemical for spas. We recommend using sodium dichlor-type granulated chlorine because it is totally soluble and nearly **pH** neutral. When used as a **sanitizer**, chlorine forms compounds called chloramines. See page 30 for discussion on **sanitizers**.

Chloramines are compounds formed when chlorine combines with nitrogen from body oils, perspiration, etc. Chloramines can cause eye irritation as well as having a strong odor. Unlike **bromamines**, chloramines are weaker, slower **sanitizers**. To remove chloramines, see the description of **shock** below.



<b>Calcium Hardness</b>	Abbreviated as CH. Calcium hardness is a measure of the total amount of dissolved calcium in the water. Calcium helps control the <b>corrosive</b> nature of the spa's water and is why soft water is not recommended. The low CH level can cause <b>corrosion</b> to the equipment and can cause staining of the spa shell. See page 29 for testing for and balancing calcium hardness.
<b>Corrosion</b>	The gradual wearing away of metal spa parts, usually caused by chemical action. Generally, corrosion is caused by low <b>pH</b> or by water with levels of <b>TA, CH, pH</b> or sanitizer which are outside the recommended ranges.
<b>Dichlor</b>	Also called sodium dichlor. It is a type of chlorine and is frequently used when <b>shocking the water</b> . An effective <b>chlorine</b> -based powdered <b>oxidizer</b> and <b>sanitizer</b> . Dichlor works by oxidizing waste product in the water such as <b>bromamines</b> and <b>chloramines</b> and causing them to burn off.
<b>Monopersulphate or MPS</b>	Frequently used when <b>shocking the water</b> . An effective non-chlorine-based powdered <b>oxidizer</b> that works well with both <b>chlorine</b> and <b>bromine</b> . It works by oxidizing waste product in the water such as <b>bromamines</b> and <b>chloramines</b> and causing them to burn off.
<b>Oxidizer</b>	<b>Shocking the water</b> with an oxidizing chemical prevents the buildup of contaminants, maximizes <b>sanitizer</b> efficiency, minimizes combined <b>chlorine</b> and improves water clarity.
<b>Ozone</b>	Ozone is a powerful oxidizing agent which is produced in nature and artificially. Ozone forms no by-products of <b>chloramines</b> (ozone actually oxidizes chloramines) and will not alter the water's <b>pH</b> .
<b>pH</b>	The pH level is the measure of the balance between acidity and alkalinity. Low pH causes the water to be too acid, which will cause <b>corrosion</b> , whereas high pH causes the water to be too alkaline, which will cause <b>scaling</b> . See page 29 for testing for and balancing pH.
<b>ppm</b>	The abbreviation of "parts per million", the standard measurement of chemical concentration in water. Identical to mg/l (milligrams per liter).
<b>Sanitizer</b>	Sanitizer is a chemical added to the water to kill bacteria and viruses and keep the water clean. The two sanitizers we recommend are <b>chlorine</b> and <b>bromine</b> . See page 30 for discussion of sanitation.
<b>Scale</b>	Rough calcium-bearing deposits that can coat spa surfaces, heaters, plumbing lines and clog filters. Generally, scaling is caused by mineral content combined with high <b>pH</b> . Additionally, scale forms more readily at higher water temperatures.
<b>Shock</b>	Also called shocking the water, shock treatment, or superchlorination. Shocking the water is adding significant doses of <b>dichlor</b> or <b>MPS</b> to <b>oxidize</b> non-filterable organic waste and to remove <b>chloramines</b> and <b>bromamines</b> . Shock treatment breaks down organic waste contaminants which cause odor and cloudy water. See page 31 for discussion of shocking the water.
<b>Total Alkalinity</b>	Abbreviated as TA. Total alkalinity is the measure of the total levels of carbonates, bicarbonates, hydroxides, and other alkaline substances in the water. TA is important for <b>pH</b> control. If the TA is too low, the <b>pH</b> will fluctuate out of control, and if it is too high, the <b>pH</b> becomes difficult to stabilize. See page 28 for testing for and balancing total alkalinity.
<b>Trichlor</b>	Used as a pool <b>sanitizer</b> . NEVER use trichlor in a spa. Trichlor is extremely acidic and will lower the <b>pH</b> , causing corrosion to equipment. Using trichlor will void your warranty.

## Water Testing Methods

There are two testing methods to choose from:

Test strips are a convenient testing method commonly used by spa owners.



The reagent test kit is a method which provides a high level of accuracy but is more expensive and more difficult to use.



## Adding Chemicals to the Spa Water

**IMPORTANT:** All spa water chemicals, including MPS (shock), chlorine, granulated pH increaser or decreaser, granulated total alkalinity increaser, calcium hardness increaser, liquid stain and scale inhibitor, and liquid de-foamer must always be added directly into or in front of the filter compartment while a jet pump is running, and it must run for a minimum of ten minutes.

1. Fold back the cover.
2. Press the **Jets** or **Jets 1** button.
3. Carefully measure the recommended amount of chemical and slowly pour it into the filter area. Use care not to splash chemicals on your hands, in your eyes, on the spa surface, or on the siding.
4. Close the spa cover.

**Warning:** High sanitizer levels can cause discomfort to the user's eyes, lungs and skin. Always allow the sanitizer level to fall to the recommended range before using the spa.

**IMPORTANT NOTE REGARDING SHOCK TREATMENT:** After administering shock to your spa, leave the cover open for a minimum of 20 minutes to allow the oxidizer gas to vent. A high concentration of trapped oxidizer gas which may exist as a result of the shock treatment (not daily sanitation) may eventually cause discoloration or vinyl degradation to the bottom of the cover. This type of damage is considered chemical abuse and is not covered under the terms of the limited warranty.

### 1. Balancing the Water Chemistry Levels

Maintaining spa water chemistry can be tricky, especially since there are many methods of keeping your water clear and clean. Follow the maintenance schedule on page 32 to determine how often you should test your water.

We do not recommend any brand of chemical. See page 32 for a table of common chemicals used in spas and their generic equivalents.

See a spa dealer for guidance and recommendations on spa chemicals and supplies. Various chemicals often sold under brand names, but a spa dealer can advise you on generic chemicals that are often much less costly than proprietary brands.

#### Balancing the Total Alkalinity (TA)

Total Alkalinity is a measure of the total levels of carbonates, bicarbonates, hydroxides, and other alkaline substances in the water. TA is referred to as the water's "pH buffer". In other words, it's a measure of the ability of the water to resist changes in pH level.

If the TA is too low, the pH level will fluctuate widely from high to low. Fluctuations in pH can cause corrosion or scaling of the spa components. Low TA can be corrected by adding sodium carbonate (pH/Alkalinity Up).

If the Total Alkalinity is too high, the pH level will tend to be high and may be difficult to bring down. It can be lowered by using sodium bisulfate (pH/Alkalinity Down).

Once the TA is balanced, it normally remains stable, although the addition of more water with a high or low alkalinity will raise or lower the TA reading of the water.

When the Total Alkalinity is within the recommended range, proceed to the next step.

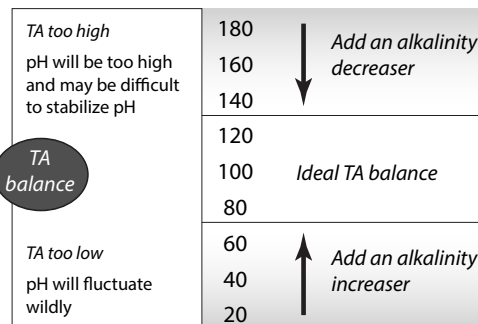

### Balancing the Calcium Hardness (CH)

Calcium Hardness is a measure of the total amount of dissolved calcium in the water. Calcium helps control the corrosive nature of the spa's water. That's why calcium-low water (commonly known as "soft" water) is not recommended. It is very corrosive to the equipment, and can cause staining of the spa shell.

If the CH is too high (commonly known as "hard water"), formation of scale on the spa's shell surface and equipment can result. You can use a generic calcium remover to remove hardness from water. CH can also be decreased by dilution – a mixture of 75% hard and 25% soft water will usually yield a reading within the correct range. If soft water is not available or practical for you, a stain and scale inhibitor should be added to the spa water, according to label instructions.

If the CH is too low add CH Increaser.

Once the CH is balanced, it normally remains stable, although the addition of more water with a high or low calcium content will raise or lower the CH reading of the water.

When the CH is within the recommended range, proceed to the next step.

<i>CH too high</i> Causes scale to deposit on spa and equipment	275	↓ <i>Dilute the spa with soft water</i>
	250	
<b>CH balance</b>	225	<i>Ideal CH balance</i>
	200	
	175	
	150	
<i>CH too low</i> Causes equipment corrosion	125	↑ <i>Add a calcium hardness increaser</i>
	100	
	75	

### Balancing the pH

The pH level is the measure of acidity and alkalinity. Values above 7.8 are alkaline; those below 7.2 are acidic. Maintaining the proper pH level is extremely important for optimizing the effectiveness of the sanitizer, maintaining water that is comfortable for the user, and preventing equipment deterioration.

If the spa water's pH level is too low, the following may result:

- The sanitizer will dissipate rapidly.
- The water may become irritating to spa users.
- The spa's equipment may corrode.

If the pH is too low, it can be increased by adding sodium hydrogen carbonate (pH/Alkalinity Up) to the spa water.

If the pH level is too high, the following may result:

- The sanitizer is less effective.
- Scale will form on the spa shell surface and the equipment.
- The water may become cloudy.
- The filter cartridge pores may become obstructed.

If the pH is too high, it can be decreased by adding sodium bisulfate (pH/Alkalinity Down) to the spa water.

NOTE: After adding sodium hydrogen carbonate or sodium bisulfate, wait two hours before testing the water for pH. Measurements taken too soon may not be accurate.

It is important to check the pH on a regular (weekly) basis. The pH will be affected by the bather load, the addition of new water, the addition of various chemicals, and the type of sanitizer used.

When the pH is within the recommended range, proceed to sanitation.

<i>pH too high</i> Too alkaline, causes scaling	8.2	↓ <i>Add a pH decreaser</i>
	8.0	
	7.8	
<b>pH balance</b>	7.6	<i>Ideal pH balance</i>
	7.4	
	7.2	
	7.0	
<i>pH too low</i> Too acidic, causes corrosion	6.8	↑ <i>Add a pH increaser</i>
	6.6	
	6.6	



## 2. Sanitation and Shock

Sanitizers kill bacteria and other organic waste by breaking them down to non-harmful levels which are filtered out. Before you fill your spa, you need to decide which chemical sanitizer you wish to use. Consult your Cal Spas dealer for the right decision with regards to your lifestyle and spa usage.

We recommend either **bromine** or **chlorine** as your sanitizer. Both work well when maintained regularly.



**DO NOT use Trichlor. Trichlor is very acidic and the hot temperature of the spa causes it to dissolve too quickly. It will cause damage to your spa and will void your warranty.**

Whichever plan you decide on, follow it completely and don't take shortcuts. It will provide you with clean, safe, clear spa water with a minimum of effort. Spa owners with an ozonator still need to use a chemical sanitizer. See page

35 for a description of how the ozonator works.

Whenever you test your chemical levels, your test strip will likely have a test for chlorine or bromine. Make sure your sanitizer falls within the range shown below.

Testing For:	Ideal Range (ppm)	
	Minimum	Maximum
<b>Chlorine Level</b>		
Without ozonator	3.0	5.0
With ozonator	2.0	4.0
<b>Bromine Level</b>		
Without ozonator	6.7	11.0
With ozonator	5.7	10.0

### Starting and Maintaining Sanitizer Levels

Sanitizing your spa with chlorine or bromine is very similar. Each sanitizer has its advantages and disadvantages.

**Bromine:** Whereas chlorine can sometimes cause offensive odors and skin irritation, bromine is less likely to do so. Additionally, unlike chlorine, when bromine combines with bather waste and other contaminants in the water, it remains a very effective sanitizer. Bromine is also far less pH-dependent than chlorine. **Always remember that bromine by itself is not a sanitizer, and it needs to be activated by shock in order to be effective.**

**Chlorine:** The most commonly recognized sanitizer is chlorine. However, the effectiveness of chlorine depends heavily on the pH level of the spa water. In order to get the most effective and economical benefit of chlorine, you must maintain a consistent pH level of between 7.2 to 7.6. A disadvantage of using chlorine is that when chlorine combines with bather waste and other contaminants in the water, not only does it lose its sanitizing ability, it can cause odors and irritate eyes and skin.

After you choose a sanitizer, you will need to establish a baseline and maintain it regularly.

Starting with fresh water:

1. Establish a baseline by adding either granulated chlorine or bromine.
  - Use half an ounce of chlorine for every 500 gallons of water.
  - Use half an ounce of bromine for every 100 gallons of water.
2. Run the jets for 10 minutes.
3. Test the water. Make sure the pH, TA, and CH levels all fall within the ranges shown on the previous page. Make adjustments where they are needed.
4. At this point, if you use bromine, it is not yet activated and **it will not sanitize the water**. You need to shock-oxidize the spa water. Depending on the size of your spa, add one to two ounces of shock. You can use any kind of shock you want.
5. Test the water again. When the water is balanced, your spa is ready to use.

Note: If you choose to use bromine, we do not recommend using a floater. You have more control over the bromine level by adding bromine as needed. For more discussion on this, see page 33, "Common Water Chemistry Questions".

## Shocking the Water

In addition to using a chemical sanitizer, you will periodically need to shock the water. Shocking helps refresh the water by breaking down organic waste contaminants which cause odor and cloudy water. After treatment, water quality and clarity is often completely restored.

The two types of shock are sodium dichlor and potassium monopersulfate (MPS). You can use either type of shock regardless of which sanitizer you use. Even if you use bromine, you can use a chlorinated shock if you wish -- in fact, you may find a chlorinated shock is more effective than dichlor or MPS alone.

If irritating chloramines are present, shocking also converts them back to active chlorine. If you use bromine sanitizer, shocking activates the bromide ion (which by itself has no disinfecting capability) which becomes hypobromous acid in water, a good sanitizer.

**Add one ounce of oxidizer shock once a week, after heavy bather loads, or if water has a strong odor.**

Spa must be running with all of the jets on high for 30 minutes with the cover open. If necessary, repeat shock in 30 minute intervals.

## 3. Filtration

The filter is the part of your spa that removes the debris from the water and needs to be cleaned on a regular basis to maximize your spa's filtering performance and heating efficiency.

**It is extremely important that you never run the spa without a filter. There is a possibility that debris may be sucked into the plumbing through the filter well.**

### Cleaning the Filter

In addition to spraying off the filter weekly to remove surface debris, your filter should be deep cleaned periodically to dissolve scale and particles that get lodged deep within the filter fibers and impede the filtration process. Even if the filter looks clean, scale and particles can clog the fibers and prevent water from flowing through the filter resulting in the most common spa problem—no heat, caused by a dirty filter.

We recommend you clean your filter at least once a month, possibly every two weeks depending on how frequently you use your spa, and replace it once a year or as necessary. See page 39 for instructions on removing and cleaning the filter.

## 4. Regularity (Maintenance Schedule)

<b>Prior to each use</b>	Test the spa water. Adjust chemical levels as necessary. Shock the water by adding ½ teaspoon of sodium dichlor per 250 gallons or 1 teaspoon of MPS per 250 gallons.
<b>After each use</b>	Add an ounce of oxidizer after heavy bather loads (see page 31 on shocking the water).
<b>Once a week</b>	Check the filter well and inside the filter pipe for leaves and foreign matter. Test the spa water. Adjust chemical levels as necessary. Shock the water by adding ½ teaspoon of sodium per 250 gallons or 3 teaspoons of MPS per 250 gallons. If your water source is high in calcium, add stain and scale preventer.
<b>Every two to four weeks</b>	Deep clean your spa's filter (see page 39). How often you clean your filter depends on how much you use your spa. There is no harm in frequently cleaning your filter and will only help your spa's efficiency.
<b>Every two to four months</b>	Change the spa water. How often you change the water depends on how much you use the spa. When you change the water, you will need to: <ul style="list-style-type: none"> <li>• Clean and polish the acrylic surface (see page 41)</li> <li>• Clean and treat the spa cover and pillows (see page 41)</li> <li>• Deep clean the filter (see page 39)</li> <li>• Refill your spa (see page 7)</li> </ul>
<b>Each time you refill the spa</b>	Follow the section "Filling and Powering Up Your Portable Spa" on page 7.
<b>Once a year</b>	Replace filter cartridges if the pleats appear frayed (see page 39).

## Generic Names for Chemicals

Water Chemistry		
Common name	Usual chemical name	Common brand names
pH Up	sodium hydroxide	pH Increaser, pH Up, pH Plus, pH Booster
pH Down	sodium bisulfate sodium bicarbonate (baking soda) sodium carbonate	pH Decreaser, pH Down, pH Minus, pH Subtractor, Dry Acid
Alkalinity increaser	sodium carbonate sodium bicarbonate (baking soda)	Alkalinity Increaser, Alkaline Up
Alkalinity decreaser	sodium bisulfate	Alkalinity Decreaser, Alkaline Down
Calcium increaser	calcium chloride	Calcium Increaser, Calcium Up, Calcium Plus, Hardness Increaser
Calcium decreaser	N/A To decrease calcium hardness, drain several gallons of water from the spa and refill using a mixture of 75% hard water and 25% soft water, or use a stain and scale inhibitor.	



Sanitizers		
Common name	Usual chemical name	Common brand names
Chlorine	sodium dichlor	Both chlorine and bromine are available under numerous brand names
Bromine	sodium bromide	

Shock		
Common name	Usual chemical name	Common brand names
MPS	monopersulphate	MPS Shock, Oxy-Spa, SeaKlear
Dichlor	sodium dichlor	Dichlor Shock

Note: Dichlor (chlorine) is both a sanitizer and a shock. Monopersulphate (MPS), when used as a shock, can be purchased alone as non-chlorinated shock or combined with dichlor, which makes it significantly more effective than MPS alone.

Other chemical additives		
Common name	Usual chemical name	Common brand names
Stain and scale inhibitor	These are usually proprietary chemical formulations and cannot be purchased as a single generic chemical.	Metal Stain Gone, Scale Inhibitor, Stain and Scale Preventer, Stain and Scale Defense
Foam inhibitor		Foam Gone, Foam Down, Defoamer
Clarifier		Water Brite, Spa Bright, Water Clarifier, Clear Water, Natural Clarifier, Brite & Clear

**Do NOT use these in your spa:**

- Sodium hypochlorite (household bleach)
- Trichlor
- Chemical floaters
- Bromine tablets
- Muriatic acid
- Borax or boric acid in any form, including brand names such as 20 Mule Team Borax or generic as sodium tetraborate
- Cyanuric acid, also called sun protector or chlorine protector

## Common Water Chemistry Questions

**Question:** Why is the use a floater not recommended to sanitize my spa water?

**Answer:** We do not recommend the use of a floater for three reasons:

- The floater is unable to control the rate at which the sanitizer is dissolved into the water. When a floater is first placed in a spa, the sanitizer level can be extremely high. High sanitizer levels can chemically burn or discolor the spa’s shell or the underside of the cover. Then, after a period of time, the sanitizer level dispensed by the floater will fall to near zero. A low sanitizer level will allow viruses, bacteria or algae to grow.
- Floaters tend to stay in one area of the spa most of the time, causing this area to be exposed to extreme sanitizer levels.
- The floater may allow pieces of the highly concentrated sanitizer to fall out and settle on the floor or seat of the spa shell. These pieces of sanitizer will chemically burn (blister) the spa shell. Although your spa shell is specifically designed to resist the effects of spa chemicals, no spa surface can withstand this type of highly concentrated chemical. Remember, chemical abuse is specifically not covered under the terms of the warranty.

**Question:** When I open my spa, I smell chlorine. How do I get rid of this smell?

**Answer:** There are two types of chlorine in your spa. The first is the Free Available Chlorine, which is the chlorine available to sanitize your spa. This free Available Chlorine does not have an odor. The second is Chloramine, which is residue from chlorine already expended. Chloramines have a strong chlorine odor. The smell from Chloramines can be eliminated by shocking the water. If you smell chlorine in the water, your spa is reminding

you to add a shock treatment.

**Question:** Why can't I fill my spa with soft water?

**Answer:** Soft water is essentially the same as regular water, except that most or all of the calcium has been replaced by sodium. Soft water may be corrosive to the heater and other components. Replacement of spa components damaged by soft water is extremely expensive.

**Question:** I am trying to reduce the number of chemicals to which my family is exposed. Do I really need to use so many chemicals and in such large amounts?

**Answer:** While over-exposure to any chemical can be unhealthy, many low levels of chemicals are effective and beneficial. In the case of spa water, the chemicals we recommend are needed to protect the user from water-borne pathogens (disease-causing microbes) and to prevent corrosion of spa components.

**Question:** Why isn't water chemistry damage covered by the warranty?

**Answer:** The chemical levels and water quality of the water in the spa are under your direct control. With proper basic care, the spa will provide many years of hot water relaxation. If you are unsure about any chemical or its usage in the spa, contact your spa dealer.

## Do's and Don'ts

- DO add all chemicals slowly into or in front of the filter compartment with the jet pump operating for ten minutes.
- DO use special care if using baking soda to clean either the interior or exterior plastic surfaces.
- DO use only a granular form of bromine sanitizer.
- DON'T use swimming pool (muriatic) acid to lower pH.
- DON'T splash pH increaser additives on the siding.
- DON'T use compressed sanitizers.

The use of bromine sticks or tablets in floaters, which may become trapped in a lounge or cooling seat (or sink to the spa floor), have been shown to cause discoloration of or surface distress to a spa's shell.

- DON'T use a floater type sanitization system as a low or no maintenance solution to your spa maintenance program.

Floating dispensers can become trapped in one area and cause an over-sanitization (or chemical burn) of that particular area.

If the dispenser setting is too high, the high concentration can discolor the spa shell and damage the underside of the cover.

Automatic floating dispensers have a tendency to either over-brominate or under-brominate as the rate of erosion varies greatly. Damage to the spa and cover can occur very quickly.

- DON'T use a sanitizer which is not designed for spas.
- DON'T use household bleach (liquid sodium hypochlorite).
- DON'T broadcast or sprinkle the chemicals onto the water surface. This method may cause chemically-induced spa surface blistering (chemical abuse).

## Bather Load

"Bather Load" is the term used to describe the number of people using a spa, combined with the length of usage, and the frequency of usage. All these factors have a great effect on the spa water. The higher the bather load, the more chemicals need to be added and a longer filtration time will be needed.

Recommendations are designed for spas with average bather load (3 to 4 people, 15 minutes of usage, three times a week at 100 degrees) If your bather load exceeds these guidelines, and you experience water quality problems, increase the amount of filtration first, (go to the next higher filtration number) then if water quality is still not adequate, consult the advice of your Cal Spas dealer for additional chemical or system recommendations. Be sure to give them your bather load information.

## Ozonator

The ozone generator releases ozone into the spa water. You will still need to test for chlorine or bromine and occasionally replenish it to return the sanitizer level to the baseline.

For spas without a circulation pump, pump 1 will run at low speed and the ozonator will run during filtration. You will need to increase your filtration to a minimum of six hours per day.

For spas with a circulation pump, the ozonator will run with the circulation pump.

The spa's control system is factory-programmed with one filter cycle that will run in the evening when energy rates are often lower. The time and duration of the filter cycle can be set according to your needs. In addition, a second filter cycle can be enabled. Filtration time may need to be increased with heavy bather load.

See instructions for setting filtration cycles on page 16.

Always make sure water diverter valves are turned all the way to the left or right and never left in the center position during filtration cycles. When the diverter valve is in the center position, there is not enough suction from the pump in order to inject ozone into the spa. The ozonator will generate ozone, but it will not be injected into the water.



## Troubleshooting Water Clarity Problems

Problem	Probable Causes	Possible Solutions
<b>Cloudy Water</b>	Dirty filter	Clean filter and run jet pump
	Excessive oils / organic matter	Shock spa with sanitizer
	Improper sanitization	Add sanitizer
	Suspended particles / organic matter	Adjust pH and/or alkalinity to recommended range
	Overused or old water	Drain and refill the spa
<b>Water Odor</b>	Excessive organics in water	Shock spa with sanitizer
	Improper sanitization	Add sanitizer
	Low pH	Adjust pH to recommended range
<b>Chlorine Odor</b>	Chloramine level too high	Shock spa with sanitizer
	Low pH	Adjust pH to recommended range
<b>Musty Odor</b>	Bacteria or algae growth	Shock spa with sanitizer – if problem is visible or persistent, drain, clean and refill the spa
<b>Organic Buildup / Scum Ring Around Spa</b>	Buildup of oils and dirt	Wipe off scum with clean rag – if severe, drain the spa, use a spa surface and tile cleaner to remove the scum and refill the spa
<b>Algae Growth</b>	High pH	Shock spa with sanitizer and adjust pH
	Low sanitizer level	Shock spa with sanitizer and maintain sanitizer level
<b>Eye Irritation</b>	Low pH	Adjust pH
	Low sanitizer level	Shock spa with sanitizer and maintain sanitizer level
<b>Skin Irritation / Rash</b>	Unsanitary water	Shock spa with sanitizer and maintain sanitizer level
	Free chlorine level above 5 ppm	Allow free chlorine level to drop below 5 ppm before spa use
<b>Stains</b>	Total alkalinity and/or pH too low	Adjust total alkalinity and/or pH
	High iron or copper in source water	Use a stain and scale inhibitor
<b>Scale</b>	High calcium content in water – total alkalinity and pH too high	Adjust total alkalinity and pH – if scale requires removal, drain the spa, scrub off the scale, refill the spa and balance the water
		Use a stain and scale inhibitor

## Removing and Reseating the Pillows

You can remove the pillows for cleaning and maintenance quickly and easily. This method works for all types of pillows.

Grab the lower edge of the pillow with both hands firmly and pull up. As you do this, the pillow inserts will pop out of the holes.

Reseat the pillows by aligning the pillow inserts with the holes and striking the pillow hard enough to insert the pegs back into the holes.

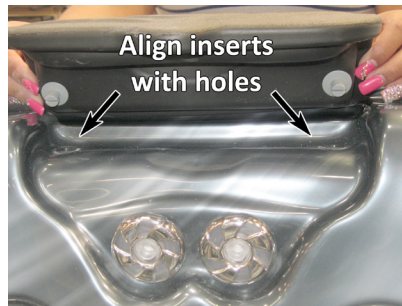

## Jet Removal and Replacement

Jets can be easily removed for cleaning.

### Screw-in jet removal

Grasp the outer rim of the jet and turn it counter-clockwise. The jet will unscrew from the fitting until it is free.

To replace the jet, place it in the fitting and turn it clockwise until it is snug in place and it can be rotated freely about half a turn. Do not overtighten the jet.

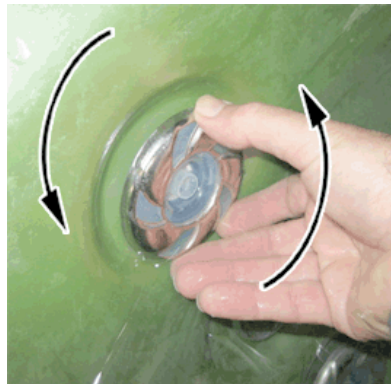

### Snap-in SQR jet removal

Grasp the outer rim of the jet and turn it counter-clockwise until it completely stops. You may feel it slightly loosen pop out a bit from the fixture. Pull the jet out from the jet fixture. The jet will be very snug and may require some force to remove it. DO NOT PRY OUT JETS.

To replace any jet, place it in the fitting and turn it clockwise until it snaps in and can be rotated freely about half a turn. Do not overtighten the jet.



## Draining Your Portable Spa

Your spa should be drained every four to six months for cleaning and maintenance and refilled with fresh tap water. See page 41 for instructions on cleaning the shell, cover, and pillows. See page 7 for instructions on refilling your spa. Before you begin, turn off power to the spa at the breaker and remove all filters.

### 1. Locate your drain.

#### *For spas with drain inside the spa*

Using a Phillips screwdriver, remove the screws to the access panel and open it. Locate hose ending with the  $\frac{3}{4}$  inch hose-bib fixture as shown below.



#### *For spas with cabinet-mounted drain*

Pull the knob out of the cabinet. The cabinet drain is screwed into the drain pull knob.



### 2. Remove the cap.

Make sure the valve is in the closed position, then unscrew and remove the cap. Unscrew the cap.

#### *For spas with drain inside the spa*

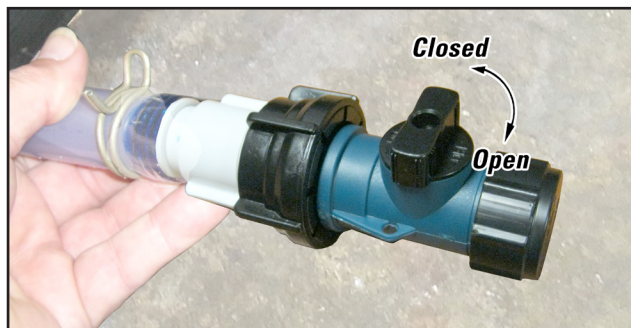

#### *For spas with cabinet-mounted drain*

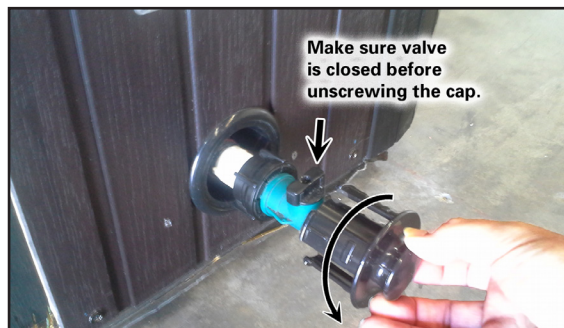

### 3. Connect valve to a garden hose.

Attach a garden hose to the hose-bib fixture. Place the other end of the garden hose where you would like the water to drain.

### 4. Drain the spa.

Turn the valve on the hose-bib fixture to open the drain. When the spa has drained completely, turn the valve on the hose-bib fixture, remove garden hose, and replace the cap.

#### *For all spas*

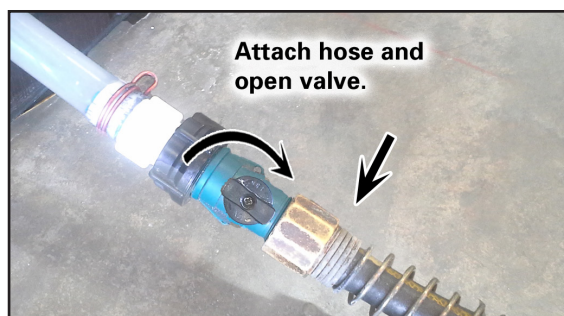



## Winterizing (Cold Climate Draining)

In many areas of the country, the temperature drops below 32°F (0°C). We recommend that you always have your spa full of water and running at normal spa temperatures (80°F to 100°F, 26.7°C to 37.8°C). This will help reduce the risk of freezing in your spa and your spa's equipment.

**Warning: If you find the need to drain your spa, be aware of the potential of freezing in your spas equipment and plumbing. Even if the directions below are followed perfectly, there is no guarantee that your spa will not suffer freeze damage. Freeze damage is not covered by your warranty.**

1. Remove the filter baskets and filters.
2. Drain your spa completely as described in the instructions above.
3. Vacuum water from the spa's main drain and from the jets with a wet/dry vacuum.
4. Open the bleeder valves on the pumps.
5. Disconnect the unions from both sides of all pumps.
6. Blow any remaining water out of the jets and equipment area with the wet/dry vacuum.
7. When the spa has completely finished draining, close the bleeder valves and re-connect the unions on all pumps. Replace the filters and filter baskets.
8. Cover your spa with a good spa cover and an all-weather tarp to ensure that neither rain nor snow enters the spa.

## Cleaning and Replacing the Filter

Filtration is one of the most important steps you can take to ensure clean, clear water. It is far less expensive to fix water clarity problems by filtering your spa than by using excessive amounts of chemicals, excessive filtration times, or by water replacement.

See the section "Cleaning the Filter" on page 31 for more information.

**Set the spa in SERENITY MODE before you remove the filter. SERENITY MODE pauses all spa operations for service functions like cleaning or replacing the filter. See page 14 for instructions on using SERENITY MODE.**

1. Remove the filter by unscrewing it and pulling it up and out.
2. Place the dirty filter into a bucket of water deep enough to cover the filter. Add 8 oz. of liquid filter cleaner to the bucket of water.

**Note:** It is a good idea to keep a spare filter to use in the spa while the dirty filter is being deep cleaned. This way, you can rotate the filters and both will last longer.

3. Soak the filter for a minimum of 24 hours.
4. Spray the filter with a water hose. Spray each pleat carefully.
5. Reinstall the filter. Do not overtighten.

## Spa Cover and Locking System Installation

Important! Keep the spa covered when not in use!

- Covered spas will use less electricity in maintaining your set temperature.
- Covering your spa will protect your spa's finish from the sun's ultraviolet rays.
- You are required to keep the spa covered to maintain

warranty coverage.

- Covering your spa helps prevent children from drowning in the spa.

In addition, while the spa cover is rigid, it is not designed to support any weight. Therefore, as a safety precaution and to preserve the life of your cover, you must not sit, stand, or lie on it, nor should you place objects of any kind on top of it.

**Step 1** - Place cover on spa. Make sure it is correctly positioned.



**Step 2** - Position the tie-down hardware (attached to the straps of your cover) on the side of the spa so they are easily reached by the cover tie-down straps.



**Step 3** - With the straps pulled taut (but not overly tight), lightly drill the location for screw placement. Gently drill 3 holes - one for each screw slot in the lock. (If you do not have a low torque drill, use the lowest torque setting on the drill you have.) DO NOT drill all the way in but instead just make a guide for starters.

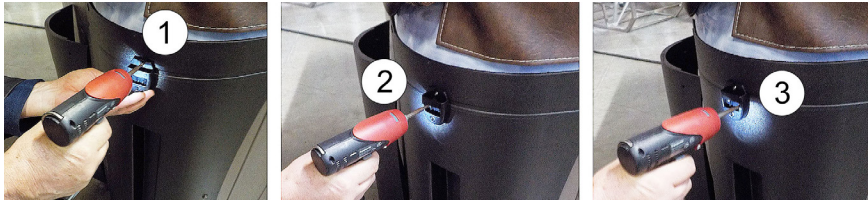

**Step 4** - Use a screwdriver to finish screwing in the 3 screws. (Repeat this process for the other 3 corners.)



**Step 5** - Keep the cover fastened down at all times when not in use. Locking hardware may be locked with a key (which is provided).



**Step 6** - The provided key will allow you to lock down spa access.

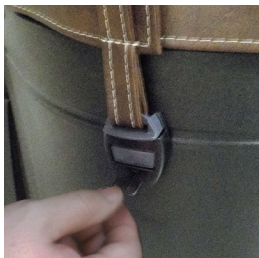

**WARNING**  
**AVOID**  
**DROWNING**  
**RISK**

FAILURE TO FOLLOW INSTRUCTIONS MAY RESULT IN INJURY OR DROWNING  
NON-SECURED OR IMPROPERLY SECURED COVERS ARE A HAZARD.  
REMOVE COVER COMPLETELY BEFORE ENTRY OF BATHERS.  
ENTRAPMENT POSSIBLE.  
KEEP COVER ON SPA AND LOCKED WHEN NOT IN USE

# Vacation Care

You can leave your spa unattended for up to two weeks if you follow these instructions.

**ALWAYS lock your cover using the cover locks if you plan to be away from home and the spa is filled with water.**

1. Select the Low Range temp choice used for vacation mode.
2. Following the water quality instructions starting on page 26, adjust the pH.
3. Shock the water (add either chlorine or bromine sanitizer).
4. When you return, check and adjust the pH and shock the water.

If you will not be using your spa for longer than 14 days and a spa maintenance service is not available, we strongly recommend you drain or winterize your spa.

# Cleaning Your Spa

## Spa Cover and Pillows

Due to the constant punishment your spa cover and pillows receive, you should protect them by applying a vinyl and leather cleaner as part of your monthly maintenance plan. Use a product that is specifically designed to protect spa covers and pillows from chemical and ultraviolet light damage without leaving an oily residue behind that is normally associated with common automotive vinyl protectants.

**Warning: Do not** use automotive vinyl protectants on spa covers or pillows. These products are generally oil-based and will cause severe water clarity issues that are difficult to correct.

## Spa Shell

Each time you drain your spa, before you refill it you should clean your spa shell with an all-purpose cleaner and apply a coat of surface protectant.

Use a low detergent, non-abrasive cleaner specifically formulated to clean the spa without damaging its acrylic finish.

Use a non-oil based surface protectant that is specifically formulated to protect the spa's finish from the chemicals and minerals associated with normal spa use.

# Using the Freedom Sound System

The Freedom Sound System™ entertainment option contains a Bluetooth-enabled speaker system that is available for certain Cal Spa models. Any Bluetooth-enabled device can be used to play audio through your spa.



Before you can use the sound system, you need to pair the Bluetooth module with your device. The Bluetooth module is installed within the spa cabinet. Everything can be done with your device. The example shown below is from an iPhone device. Your device may appear differently. Before you begin, make sure Bluetooth is enabled on your device.

1. Select Bluetooth from your device's option list.
2. Select **SWA8-6BT...** from the list of available devices to pair.
3. Your iPhone device will ask for a code: the code is **0000**.
4. Allow your device to pair with the spa's Bluetooth module.
5. When the devices have been connected, the device **SWA8-6BT...** will be highlighted.

Only one Bluetooth device can be paired with the Freedom Sound System™ at any time.

(For Android users, the systems will pair automatically - no code is needed.)

Once your device is paired and connected, all sounds from your device will be played through the sound system, including system sounds and telephone.

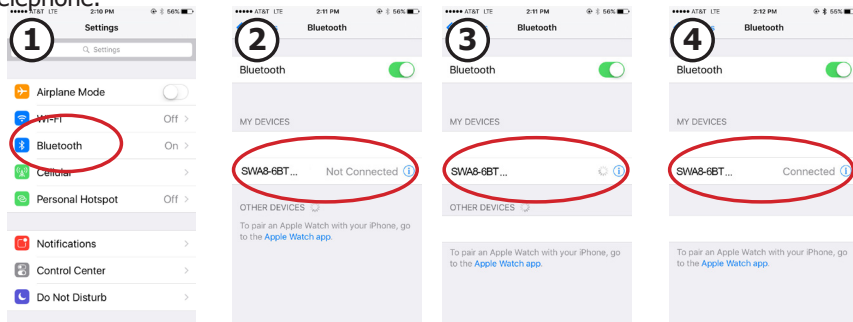





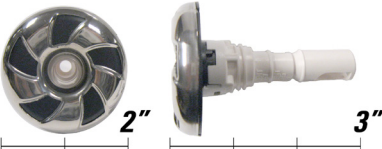

# Appendix

Please visit [www.quickspaparts.com](http://www.quickspaparts.com) to order your replacement parts.

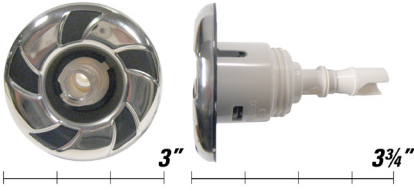

## Replacement Parts

Screw-in Jet Inserts	
Description	Used by
<b>ELE 2" Euro No Eyeball</b> PLUCS2295021S 	Patio Patio+ Inground Spas
<b>ED 2" Euro Directional</b> PLUCS2295051S 	Patio Patio+ Inground Spas
<b>MED 3" XL Cluster Storm Directional</b> PLUCS2295031S 	Patio Patio+ Inground Spas
<b>mfd 3" Micro Flow Directional</b> PLUCS2295061S 	Patio Patio+ Inground Spas

Screw-in Jet Inserts	
Description	Used by
<b>MFD 3.5" Maxi Flow Directional</b> PLUCS2295091S 	Patio Patio+ Inground Spas
<b>PSD 5" Power Storm</b> PLUCS2295131S 	Patio Patio+ Inground Spas
<b>ET 2" Cluster Storm Twin</b> PLUCS2295161S 	Patio Patio+ Inground Spas
<b>MMP 3" Mini Multi-Massage</b> PLUCS2295171S 	Patio Patio+ Inground Spas

**Note:** All Cal Spa models use a combination of screw-in and snap-in jet inserts where removable jets are used.

Please visit [www.quickspaparts.com](http://www.quickspaparts.com) to order your replacement parts.

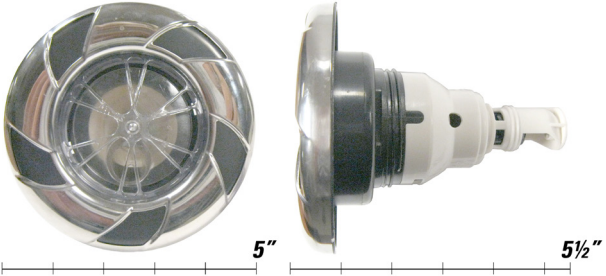
Screw-in Jet Inserts	
Description	Used by
<b>PSTR 5" Power Storm Twin Roto</b> PLUCS2295181S 	Patio Patio+ Inground Spas
<b>MMP 5" Power Storm Riffed</b> PLUCS2295141S 	Patio Patio+ Inground Spas
<b>PST 5" Power Storm Wagon Wheel</b> PLUCS2295191S 	Patio Patio+ Inground Spas

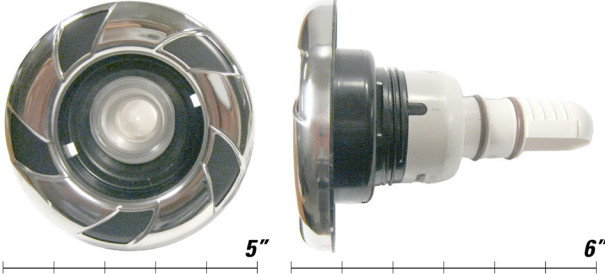
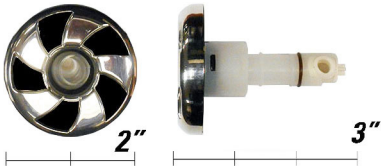





Screw-in Jet Inserts	
Description	Used by
<b>T 5" Tornado Adjustable</b> PLUCS2295201S 	Patio Patio+ Inground Spas
<b>2" Neck Jet Directional</b> PLU29923-014-000 	Patio Patio+ Inground Spas

Please visit [www.quickspaparts.com](http://www.quickspaparts.com) to order your replacement parts.

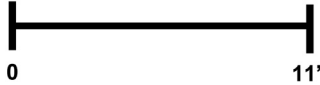
Water Diverter Valves	
<p><b>Diverter Valve 2" Titanium Black (CS600303T1-TT)</b> PLU21300465</p>	
<p><b>Diverter Valve 1" Titanium Black (CS600426T1-TT)</b> PLU21300453</p>	
<p><b>Diverter Valve 1 1/2" On/Off ASSY (600-4601)</b> PLU21100045</p>	

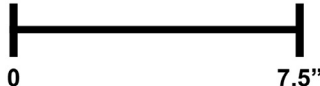
Air Control Valve	
<p><b>Air Control with Titanium Black CS660350T1-TT</b> PLU21300504</p>	
<p><b>Aquatic Air Therapy (AAT) Air Control</b> PLU25059-211-00</p>	

Drains	
<p><b>Drain Super Hi Flo Suction 2 1/2" Black (640-3581LGV)</b> PLU21400146</p>	
<p><b>Low Profile Drain 3/4" Black (640-0511)</b> PLU21400401</p>	

Pillows	
<p><b>Cascade Pillow No Insert Black</b> ACC01401031</p>	 
<p><b>Infinity Pillow Ribbed Black</b> ACC01401051</p>	 
<p><b>Infinity Pillow Plain Black</b> ACC01401061</p>	 
<p><b>Y Pillow recess</b> ACC01401101</p>	 

Filters	
<p><b>50 sq ft</b></p>	<p><b>FIL50-5D13H15FCT-3</b></p> 



Please visit [www.quickspaparts.com](http://www.quickspaparts.com) to order your replacement parts.

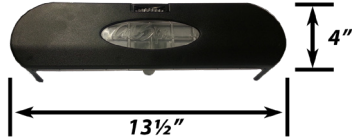

Filters	
75 sq ft	<p>FIL75-5D17H15FCT-3</p> 
75 sq ft Mega	<p>FIL75-7D155H2MCT-3</p> 
<p>DYNA FLO XTRA Lo-Pro 75 SQ. Ft.</p> <p>2" CV, 4 SCALLOP (less cartridge)</p>	<p>FIL11703305</p> 

Teleweir Skimmers	
<p>50 square foot teleweir skimmer:</p>	 
<p>Filter attaching cap assembly</p> <p>FIL11700013</p>	
<p>Filter skimmer inner pipe</p> <p>FIL11700012</p>	
<p>75 square foot teleweir mega skimmer:</p>	 
<p>Filter attaching cap assembly</p> <p>FIL11700025</p>	
<p>Filter skimmer inner pipe</p> <p>FIL11700026</p>	

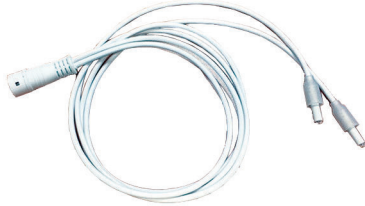
Waterfalls	
<p>Cascade II Waterfall Black textured with valve and logo 12 -3/8" '14</p>	
<p>PLU21800825TEX</p>	
<p>Cascade II Waterfall Curved Black Textured with Valve and Logo 12-3/8" '14</p>	
<p>PLU21800828</p>	

LED Lights	
<p><b>1-LED light string</b> LIT16100330</p> 	
<p><b>2-LED light string</b> LIT16100331</p> 	
<p><b>4-LED light string</b> LIT16100332</p> 	
<p><b>1 to 3 ext. cord</b> LIT16100335</p> 	
<p><b>1 to 1 port ext. cord</b> LIT16100338</p> 	

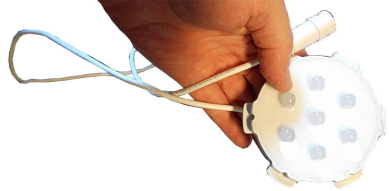
Please visit [www.quickspaparts.com](http://www.quickspaparts.com) to order your replacement parts.

LED Lights	
<p><b>Interior light with logic (7 LED)</b> LIT16100333</p> 	
<p><b>Interior light without logic (7 LED)</b> LIT16100337</p> 	
<p><b>Main light housing, LED lens, fitting nut</b> LIT16100336</p> 	

**Replacement Cabinet Panels**

The complete selection of replacement cabinets for all models is very extensive and too lengthy for this owner's manual. To order replacement panels for your spa, visit [www.quickspaparts.com](http://www.quickspaparts.com).

## Covers

All spa covers are designed with a tapered height, angling downward from the center to the sides to drive off rain and prevent water from pooling. The covers listed below are filled with either 1.5 lb or 2.0 lb foam.

**Standard**

4" - 2.5"  
1.5 Lb. foam

**Deluxe**

5" - 3"  
2.0 Lb. foam

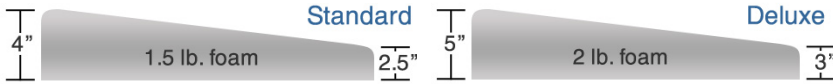

	<b>Taper Dark Brown Basic</b>	<b>Taper Black Basic</b>	<b>Taper Gray Basic</b>	<b>Taper Dark Brown Standard</b>	<b>Taper Black Standard</b>	<b>Taper Gray Standard</b>
<b>54" x 78"</b> Fits spa models: PZ-517L, PPZ-525L	COV5478BDB-3	COV5478BBK-3	COV5478BG-3	COV5478SDB-3	COV5478SBK-3	COV5478SG-3
<b>64" x 84"</b> Fits spa model: PPZ-537L	COV6484BDB-3	COV6484BBK-3	COV6484BG-3	COV6484SDB-3	COV6484SBK-3	COV6484SG-3
<b>72" x 72" triangle</b> Fits spa models: PZ-617T, PPZ-628T	COV7272TRBDB-3	COV7272TRBBK-3	COV7272TRBG-3	COV7272TRSDB-3	COV7272TRSBK-3	COV7272TRSG-3
<b>78" x 84"</b> Fits spa models: PZ-621L, PPZ-631L	COV7884BDB-3	COV7884BBK-3	COV7884BG-3	COV7884SDB-3	COV7884SBK-3	COV7884SG-3
<b>78" round</b> Fits spa model: P2511R	COV78RDBDB-3	COV78RDBBK-3	COV78RDBG-3	N/A	N/A	N/A
<b>87" x 87"</b> Fits spa model: EP-760DL, EC-754DL	COV8787BDB-3	COV8787BBK-3	COV8787BG-3	COV8787SDB-3	COV8787SBK-3	COV8787SG-3

	<b>Black Deluxe</b>	<b>Taper Black Deluxe</b>	<b>Taper Dark Brown Deluxe</b>	<b>Taper Gray Deluxe</b>
<b>93" x 130"</b> Fits spa model: EC-947E	COV93130DBBK-3	COV93130DBK-3	COV93130DDB-3	COV93130DG-3
<b>84" x 84" (7 foot spas)</b> Fits spa models: P2-722L, P2-722B, PP-732L+, PP-732B+, EC-735L, EC-735B, EC751L, EC751B, EP-761L, EP-761B, PL-760L, PL-760B, PPL7L+	N/A	COV8484SBK-3 (Standard)	COV8484SDB-3 (Standard)	COV8484SG-3 (Standard)
<b>93" x 93" (8 foot spas)</b> Fits spa models: EC-835L, EG835B, EC-851L, EC-851B, EC-852L, EC-864L, EC-864B, EP-861L, EP-864B, PL-860L, PL-861B, PL-880L, PL-881B, PPL-8B+	N/A	COV9393DBK-3	COV9393DDB-3	COV9393DG-3



## Basic Troubleshooting

The troubleshooting guidance provided here is intended to cover the most common problems a spa owner may encounter. For more in-depth troubleshooting, go to [www.calspas.com/troubleshooting](http://www.calspas.com/troubleshooting).

Symptom	Possible Solutions
<b>Problems starting up</b>	
Pump won't prime	See priming instructions on page 10.
Breaker keeps shutting off	Reset the GFCI breaker. If this continues, contact your dealer or a qualified spa technician.
<b>Power and system problems</b>	
System won't start up or breaker keeps shutting off	Power may be shut off. Turn on GFCI circuit breaker. If this continues, contact your dealer or a qualified spa technician.
Control panel doesn't respond	Turn on or reset the GFCI circuit breaker. If this does not solve the problem, contact your dealer or a qualified spa technician.  If you hear the pump running but the control panel doesn't respond, contact your dealer
Spa does not turn off	Spa may be trying to heat up. Check if spa is in Ready or Rest mode.  In cold climates, if spa is not equipped with full foam or any kind of insulation, it will try to maintain the set temperature. Set the spa to low temperature range and set the temperature to 80°F.  Spa may be in filter cycle. If it is, this is normal and no adjustment is necessary.
Message on the control panel	There may be a problem. See Error Screens on page 15.
<b>Heat problems</b>	
Spa water does not get hot	Spa may be in low temperature range. Set the spa to high temperature range.  The filter may be dirty or may need to be replaced. Clean or replace the filter.  The water level may be too low. Fill the spa with water level at 4 to 6 inches from the top.  The temperature is not turned up high enough. Raise temperature on topside control.  Cover the spa. The cover will keep heat in the spa and help keep heat from escaping. Make sure cover is on at all times when spa is not in use.  The heater element may be old, deteriorated, coated with scale, or defective. Contact your dealer for more assistance.  The gate valves may be partially or completely closed. NEVER OPERATE YOUR SPA WITH THE GATE VALVES CLOSED!

Please visit [www.quickspaparts.com](http://www.quickspaparts.com) to order your replacement parts.

Symptom	Possible Solutions
Spa overheats - temperature greater than 110°F / 43°C	<p>Overheating can occur during summer months and may not necessarily indicate a malfunction. When it occurs, a message code may also appear on the control panel.</p> <p>Temperature may be set too high. Turn the set temperature down to a lower temperature.</p> <p>Filtration time may be too long. Turn the filtration cycles down during the warm months.</p> <p>The spa may not be properly ventilated. Make sure the front of the spa is not blocked to allow air flow.</p> <p>High speed pumps may have been running too long. Limit pump running time to no more than 15 to 30 minutes.</p>

### Water pressure problems

Low water pressure	<p>Jet valves may be partially or fully closed. Open the jet valves.</p> <p>Filter cartridge may be dirty. Clean or replace the filter.</p> <p>Pump may have airlock. Remove airlock by priming spa (page 10)</p> <p>The suction fittings may be blocked. Remove any debris that may be blocking them.</p> <p>The filter skimmer may be blocked. Remove the blockage.</p> <p>Gate valves may be closed. Open gate valves. Note: Never operate your spa with the gate valves closed!</p> <p>Spa may be running in filtration mode. Press JETS or JETS 1 button to turn on high speed pump.</p>
No water pressure (no water stream from any jets)	<p>Power may be switched off. Turn the power back on.</p> <p>The pump may be defective. After you have tried all other troubleshooting, contact your dealer for assistance.</p>
Jets surge on and off	Water level may be too low. Add water to normal level.

### Pump problems

Pump runs constantly – will not shut off	There may be a problem with circuit board. Contact your dealer.
Noisy pump	<p>The water level may be too low. Fill the spa with water level at 4 to 6 inches from the top.</p> <p>Filter cartridge may be dirty. Clean or replace the filter.</p> <p>Pump may have airlock. Remove airlock by priming spa (page 10)</p> <p>The suction fittings may be blocked. Remove any debris that may be blocking the suction fittings.</p> <p>Gate valves may be closed. Open gate valves. Note: Never operate your spa with the gate valves closed!</p> <p>Air may be leaking into the suction line. Contact your dealer for assistance.</p> <p>Debris may be inside the pump. Contact your dealer for assistance.</p> <p>Noise may be a sign of damage. Contact your dealer for service.</p>

Symptom	Possible Solutions
Pump turns off during operation	Automatic timer may have completed its cycle. Press JETS or JETS 1 button to start the cycle again. Pump may have overheated due to the vents on the equipment door being blocked. Make sure the front of the spa is not blocked to allow air flow. The pump motor may be defective. Contact your dealer for assistance.
Pump has a burning smell while running	A burning smell may be a sign of damage. Contact your dealer for service.
Pump does not run	Pump may have over heated. Let it cool for an hour and try operating the spa for a shorter time. Power to the spa may be shut off. Turn on or reset the GFCI circuit breaker. If this does not solve the problem, contact your dealer or a qualified spa technician.

## “Thermal Creep”

Cal Spas are designed with energy-efficient components and systems that are meant to sustain heat generated by the equipment, which is then cycled back into the spa water. In hot weather or in situations where the spa is set to extended run times, Thermal Creep may occur. Thermal Creep is a condition where the measured water temperature can be higher than the set temperature. To manage Thermal Creep you may:

**Vent your cover.** This means placing a folded cloth about  $\frac{3}{4}$ " (2cm) thick under all four corners of the cover before you lock the cover down.

**Open your cover.** Opening the cover at night will also quickly cool the water down if desired.

**Open all air controls.** Set your filtration cycles to run during the cooler times of the day or night.

**Reduce the length of your filter cycles.**

**Visit your local dealer for additional guidance.**

Since Thermal Creep only occurs in well-insulated hot tubs, it is not indicative of something that is wrong with your spa or its equipment.

# LIMITED WARRANTY

This Limited Warranty is extended to the original purchaser of a Cal Spa brand portable spa manufactured after January 1, 2020 and installed for residential use in the United States of America and Canada. This warranty begins on the date of delivery of the spa, but in no event later than one year from the date of manufacture.

This warranty applies only to this spa line:

**Special Edition**

**Shell Structural**

Warranted against water loss due to defects in the spa shell.

5 years

**Shell Finish**

Warranted against blistering, cracking, or delaminating of the interior surface of the spa shell.

2 years

**Equipment and Controls**

Electrical equipment components – specifically limited to the pumps, standard titanium heater, and control system – are warranted against malfunctions due to defects in workmanship or materials.

2 years

**Plumbing**

Warranted against leaks due to defects in workmanship or materials.

1 year

**Cabinet - Synthetic or Fiberglass**

Warranted against defects in workmanship or materials. Normal wear and weathering of the finish will occur naturally over time and are not defects.

1 year

### Warranties for Other Components

The fuses, headrests, cabinet finish, and filters are warranted to be free of defects in workmanship and material at the time of delivery. All stereo-related components (receiver, speakers, sub-woofer, stereo media locker, power supply, wireless remote control etc.) are warranted against malfunction due to defects in workmanship or material for one year from the original date of delivery. All other factory-installed components not mentioned specifically, including, but not limited to the wood frame, jets, diverter valves, LED lighting systems, filter lids, and mechanical components, are warranted against malfunction due to defects in workmanship and material for two years from the original date of delivery. The spa cover delivered with the spa is warranted for 90 days.

### Genuine Cal Spas Parts & Accessories

This Limited Warranty is void if Cal Spas (the "Manufacturer") or its designated representative determines that the spa has been subjected to damage or failure due to installation of aftermarket parts that are not genuine Cal Spas branded parts and accessories. This disclaimer includes, but is not limited to filters, ozone systems, salt systems, repair parts and other accessories. Genuine Cal Spas brand parts and accessories are built to our highest standards of quality, durability and performance, and they are designed to work with your spa to ensure optimal performance and function.

### Performance

This warranty begins on the date of delivery of the spa, but in no event later than one year from the date of manufacture.

To obtain service in the event of a defect covered by this Limited Warranty, notify your Cal Spa dealer or Cal Spas as soon as possible and use all reasonable means to protect the spa from further damage. Upon proof of purchase, a designated service representative will correct the defect subject to the terms and conditions contained in this Limited Warranty. There will be no charge for parts or labor to repair the defect, although providing access to affect the repair is your responsibility as the spa owner. Freight charges for replacement parts is the responsibility of the spa owner. You may be assessed reasonable repairman travel mileage charges.

In the event that the spa is removed to a repair facility for repair and reinstalled, the cost of removal and reinstallation will be your responsibility as the spa owner. If the Manufacturer determines that repair of the covered defect is not feasible, it reserves the right to provide a replacement spa of equal value to the original purchase price. In such an event, reasonable costs for



Please visit [www.quickspaparts.com](http://www.quickspaparts.com) to order your replacement parts.

removal of the original spa, shipping costs from the factory for the replacement spa and delivery and installation of the replacement will be your responsibility as the spa owner. The replacement spa will carry the balance of the original spa's warranty. Spa covers are not included.

This warranty ends either by specified time frame, owner-transfer, relocation, or installation of any component other than by manufacturer.

### Warranty Limitations

This Limited Warranty is void if Cal Spas or its designated representative determines that the spa has been subjected to alteration, neglect, misuse or abuse, or freight damage caused by the common carrier; any repairs have been attempted by anyone other than a designated representative; the failure is caused by accident, acts of God or other causes beyond the control of the Manufacturer; neglect, misuse and abuse include any installation, operation or maintenance of the spa other than in accordance with the instructions contained in the owner's manual provided with the spa, including but not limited to the failure to maintain proper water chemistry and chemical balance and the use of abrasive or improper cleaners or non-genuine parts and accessories. This Limited Warranty does not provide coverage for any item attached to or installed on the spa after the date of manufacture or for gaining access to any component for repair or replacement. Spa units in commercial use are excluded from any coverage whatsoever. The spa owner accepts liability for repair work performed by anyone other than the Manufacturer or a designated Cal Spa representative. This Limited Warranty is void if damage occurs to the spa shell because of excessive heat buildup due to failure to cover a spa that is empty of water while exposed to direct sunlight.

### Proration of Warranty

Units determined by the Company to be non-repairable will be replaced on a prorated basis with the same or a comparable unit. The user will be charged one percent of the current retail cost for each full month of ownership from the date of purchase through the date failure is determined to be non-repairable. This charge will be waived during the first twelve months of ownership.

### Limitations

The Manufacturer disclaims all warranties, expressed or implied, in fact or in law, to the extent allowed by your State's Law, including the warranty of merchantability and fitness for use, except as stated specifically herein. All warranty service must be performed by the Manufacturer or its designated representative using authorized Cal Spa parts. No agent, dealer, distributor, service company or other party is authorized to change, modify or extend the terms of this limited warranty in any manner whatsoever. The Manufacturer will not be responsible for any statements or representations made in any form that go beyond, are broader than, or are inconsistent with any authorized literature or specifications furnished by Cal Spas.

### Disclaimers

The Manufacturer and its representatives shall not be liable for any injury, loss, cost or other damage, whether incidental or consequential, arising out of any defect covered by this limited warranty, including without limitation, loss of use of the spa and cost for removal of defective product even if the Manufacturer was advised of the possibility of damage. The liability of the Manufacturer under this limited warranty, if any, shall not exceed the original amount paid for the defective product. Coverage under this limited warranty shall commence as of the original date of delivery and the duration of such coverage shall not extend for any reason whatsoever beyond the stated time periods. These disclaimers shall be equally applicable to any service provided by the Manufacturer and its designated representatives.

### Legal Rights

This Limited Warranty gives you specific legal rights. You may also have other rights that vary from state to state. Some states do not allow limitations on how long an implied warranty lasts, so this limitation may not apply to you.













## Warranty Registration

Registering your new Cal Spas product is quick and easy. It is important that you register your Cal Spas product as soon as possible. By taking just a few quick minutes to register, you can enjoy product alerts, more efficient support, and quicker service.

Go to <https://calspas.com/register-your-spa.php>. Fill in your information and click "SEND WARRANTY INFO"

**Locating the product serial number:** The serial number of your spa is located on a metal plate attached to the inside of the door for the equipment area. You will need this number to properly register your spa and activate coverage. Write this information in the space provided below.

Spa Model: \_\_\_\_\_

Spa Serial Number: \_\_\_\_\_

Date Purchased: \_\_\_\_\_

Date Installed: \_\_\_\_\_

Dealer's Phone Number: \_\_\_\_\_

Dealer's Address: \_\_\_\_\_

**Please visit [www.quickspaparts.com](http://www.quickspaparts.com) to order your replacement parts.**

LTR20201163, Rev. Z7  
4/26/21