



All Portable Spas

Manufactured after November 23, 2009

2010 OWNER'S MANUAL

United States and Canada



© 2010 LMS, Inc.



Cal Spas Home Resort™

www.calspas.com

Preparing for Your New Portable Spa

Planning the Best Location	3
Preparing a Good Foundation	3
120 Volt Electrical Installation	4
240 Volt Electrical Installation	4
GFCI Wiring Diagram	7
Gas Heater Hook up	8
Filling and Powering Up Your Portable Spa	10
Priming the Pump	11

Operating Your Spa

5100, 6200 and 6300 Electronic Control Operation	12
9800 Electronic Control Operation	14
"Sounds Good" System Operation	17
Auxiliary Control Panels	17
Periodic Reminder Messages	18
Diagnostic Messages	18
Electrical Power Efficiency	20
Jets	21
Diverter Knobs	21
Waterfalls	21
Air Venturis	21
Adjustable Therapy System	22
Wireless Spa Monitor	22
LED Perimeter Lighting	23

Clear Water Plan

The Key to Clear Water	24
Testing and Adjusting Spa Water	25
Sanitation	26
About the Pure XL Water Sanitizer	28
Filter Cleaning	28

Bather Load	29
Starting the Spa with Fresh Water	29
Maintenance Schedule	30
Cal Zone Quest Ozonator	31
Cal Clarity Bromine Generator	31
Troubleshooting Water Clarity Problems . .	33

Cleaning and Maintenance

Removing and Reseating the Pillows	34
Spa Cover	34
Draining Your Portable Spa	35
Cleaning and Replacing the Filter	35
Winterizing (Cold Climate Draining)	36
Vacation Care	36
Cleaning Your Spa	37
Jet Removal and Replacement	38

Using the Entertainment System

Listening to the Radio	39
Inserting and Ejecting a Disk	39
Playing a CD	39
Using the iPod Docking Station	40
Programming the Universal Remote Control 40	
Using the iSound Remote Music System . .	41
About the SunBriteTV Monitor	41

Appendix

Replacement Parts	42
Keeping Fit with your Spa	50
Troubleshooting	52
Cal Spas™ Chemicals	55
2010 Warranty	56
Warranty Registration	58

CONTACT INFORMATION

For customer service, please contact your authorized dealer immediately. If you need additional information and/or assistance, contact:

**LMS Customer Service Department
1462 East Ninth Street
Pomona, CA 91766.**

Toll Free: 1-800-CAL-SPAS
Fax: 1-909-629-3890

Copyright 2009-2010 LMS, Inc. All rights reserved. Duplication without written consent is strictly prohibited.

Cal Spas®, Adjustable Therapy System™, ATS™, Cal Zone Quest 2000™, Cal Premium™, Cal Select™, Cal Stone™ Ultimate Fitness Spa Series™, and XL Heat Exchanger™ are registered trademarks.

Due to continuous improvement programs, all models, operation, and/or specifications are subject to change without prior notice.

LTR20101000, Rev. B
12/31/09

Important Safety Instructions

READ AND FOLLOW ALL INSTRUCTIONS.

WARNING:

To reduce the risk of injury, do not permit children to use this product unless they are closely supervised at all times.

DANGER -- Risk of accidental drowning:

Do not allow children to be in or around a spa unless a responsible adult supervises them. Keep the spa cover on and locked when not in use. See instructions enclosed with your cover for locking procedures.

DANGER -- Risk of injury:

The suction fittings in this spa are sized to match the specific water flow created by the pump. Should the need arise to replace the suction fittings, or the pump, be sure the flow rates are compatible.

Never operate the spa if the suction fitting or filter baskets are broken or missing. Never replace a suction fitting with one that is rated less than the flow rate marked on the original suction fitting.

DANGER -- Risk of electric shock:

Install the spa at least 5 feet (1.5 meters) from all metal surfaces. As an alternative, a spa may be installed within 5 feet of metal surfaces if each metal surface is permanently bonded by a minimum #8 AWG solid copper conductor to the outside of the spa's control box.

DANGER -- Risk of electric shock:

Do not permit any external electrical appliances, such as lights, telephones, radios, televisions, and etc., within five feet (1.5 meters) of the spa. Never attempt to operate any electrical device from inside the spa.

WARNING -- To reduce the risk of injury:

The spa water should never exceed 104°F (40°C). Water temperatures between 100°F (38°C) and 104°F (40°C) are considered safe for a healthy adult. Lower water temperatures are recommended for young children and when spa use exceeds 10 minutes.

High water temperatures have a high potential for causing fetal damage during pregnancy. Women who are pregnant, or who think they are pregnant, should always check with their physician prior to spa usage.

The use of alcohol, drugs or medication before or during spa use may lead to unconsciousness, with the possibility of drowning.

Persons suffering from obesity, a medical history of heart disease, low or high blood pressure, circulatory system problems or diabetes should consult a physician before using the spa.

Persons using medications should consult a physician before using the spa since some medications may induce drowsiness while others may affect heart rate, blood pressure and circulation.

HYPERTHERMIA DANGER:

Prolonged exposure to hot air or water can induce hyperthermia. Hyperthermia occurs when the internal temperature of the body reaches a level 3°F to 6°F above the normal body temperature of 98.6°F (or 2°C to 4°C above 37°C). While hyperthermia has many health benefits, it is important not to allow your body's core temperature to rise above 103°F (39.5°C).

Symptoms of excessive hyperthermia include dizziness, lethargy, drowsiness and fainting. The effects of excessive hyperthermia may include:

- Failure to perceive heat
- Failure to recognize the need to exit spa or hot tub
- Unawareness of impending hazard
- Fetal damage in pregnant women
- Physical inability to exit the spa
- Unconsciousness

WARNING: The use of alcohol, drugs, or medication can greatly increase the risk of fatal hyperthermia.

DANGER -- Risk of electric shock:

- Replace a damaged power cord immediately.
- Do not bury the power cord.
- Connect to a grounded, grounding-type receptacle only.

WARNING: People with infectious diseases should not use a spa or hot tub.

WARNING: To avoid injury, exercise care when entering or exiting the spa or hot tub.

WARNING: Do not use drugs or alcohol before or during the use of a spa or hot tub to avoid unconsciousness and possible drowning.

WARNING: Do not use a spa or hot tub immediately following strenuous exercise.

WARNING: Prolonged immersion in a spa or hot tub may be injurious to your health.

CAUTION: Maintain water chemistry in accordance with manufacturer's instructions.

SAVE THESE INSTRUCTIONS.

Preparing for Your New Portable Spa

Most cities and counties require permits for exterior construction and electrical circuits. In addition, some communities have codes requiring residential barriers such as fencing and/or self-closing gates on property to prevent unsupervised access to the property by children. Your dealer can provide information on which permits may be required and how to obtain them prior to the delivery of your spa.

Planning the Best Location

Safety First

Do not place your spa within 10 feet (3 m) of overhead power lines.

Consider How You Will Use Your Spa

How you intend to use your spa will help you determine where you should position it. For example, will you use your spa for recreational or therapeutic purposes? If your spa is mainly used for family recreation, be sure to leave plenty of room around it for activity. If you will use it for relaxation and therapy, you will probably want to create a specific mood around it.

Plan for Your Environment

If you live in a region where it snows in the winter or rains frequently, place the spa near a house entry. By doing this, you will have a place to change clothes and not be uncomfortable.

Consider Your Privacy

In a cold-weather climate, bare trees won't provide much privacy. Think of your spa's surroundings during all seasons to determine your best privacy options. Consider the view of your neighbors as well when you plan the location of your spa.

Provide a View with Your Spa

Think about the direction you will be facing when sitting in your spa. Do you have a special landscaped area in your yard that you find enjoyable? Perhaps there is an area that catches a soothing breeze during the day or a lovely sunset in the evening.

Keep Your Spa Clean

In planning your spa's location, consider a location where the path to and from the house can be kept clean and free of debris.

Prevent dirt and contaminants from being tracked into your spa by placing a foot mat at the spa's entrance where the bathers can clean their feet before entering your spa.

Allow for Service Access

Many people choose to install a decorative structure around their spa. If you are installing your spa with any type of structure on the outside, such as a gazebo, remember to allow access for service. It is always best to design special installations so that the spa can still be moved, or lifted off the ground.

Preparing a Good Foundation

Damage caused by inadequate or improper foundation support is not covered by the warranty.

It is the responsibility of the spa owner to provide a proper foundation for the spa.

We strongly recommend that you have a qualified, licensed contractor prepare the foundation for your spa.

Place the spa on a level foundation (preferably a 4" concrete slab). If you are installing the spa indoors, pay close attention to the flooring beneath it. Choose flooring that will not be damaged or stained.

If you are installing your spa on an elevated wood deck or other structure, consult a structural engineer or a contractor to ensure the structure will support the weight of 150 pounds per square foot.

120 Volt Electrical Installation

Always follow applicable local, state and federal codes and guidelines.

Use only a dedicated electrical line with a 20 amp breaker.

Cord-and-plug connections may not use a cord longer than 15 feet (4.6 m) and must be plugged into a dedicated 20 amp GFCI connection (NEC 680.42(A) (2)). Do not use extension cords!

Always use a weatherproof-covered receptacle.

Receptacle shall be located not less than 5 feet (1.5 m) from and not exceeding 10 feet (3.0 m) from the inside wall of the spa. (NEC 680.43(A))

Do not bury the power cord. If your cord becomes damaged, replace it before next usage.

All 120V spas must have a GFCI. This can be either a 20 amp GFCI receptacle or a 20 amp GFCI cord and plug kit as shown (CKIT110 - P/N ELE09700086).

Test the GFCI plug prior to first use and periodically when the spa is powered. To test the GFCI plug version, follow these instructions. (Spa should already be plugged in and operational.)

1. Press the TEST button on the GFCI. The GFCI will trip and the spa will stop operating.
2. Press the RESET button on the GFCI. The GFCI will reset and the spa will turn back on.

The spa is now safe to use.

If the GFCI trips while the spa is in use, press the RESET button. If the GFCI does not reset, unplug the spa and call your local Cal Spas dealer for service. DO NOT USE THE SPA!

240 Volt Electrical Installation

All 240V spas must be permanently connected (hardwired) to the power supply. See the wiring diagram on page 7.

These instructions describe the only acceptable electrical wiring procedure. Spas wired in any other way will void your warranty and may result in serious injury.

When installed in the United States, the electrical wiring of this spa must meet the requirements of National Electric Code, ANSI/NFPA 70-2008 and any applicable local, state, and federal codes.

The electrical circuit must be installed by an electrical contractor and approved by a local building or electrical inspector.

Failure to comply with state and local codes may result in fire or personal injury and will be the sole responsibility of the spa owner.

GFCI and Wiring Requirements

The power supplied to the spa must be on a dedicated GFCI protected circuit as required by ANSI/NFPA 70 with no other appliances or lights sharing the power.

Use copper wire with THHN insulation. Do not use aluminum wire.

Use the table on the next page to determine your GFCI and wiring requirements.

When NEC requires the use of wires larger than #6 AWG, install a junction box near the spa and use #6 AWG wire between the junction box and the spa.

Wire runs over 85 feet must increase wire gauge to the next lower number. For example: A normal 50 amp GFCI with four #8 AWG Copper wires run over 85 feet would require you to go to four #6 AWG copper wires.

Read and follow the heater manufacturer's safety and installation instructions prior to installation and operation. Incorrect installation may damage the heater and void its warranty.

Testing the GFCI Breaker

Test the GFCI breaker prior to first use and periodically when the spa is powered. To test the GFCI breaker follow these instructions (spa should be operating):

1. Press the TEST button on the GFCI. The GFCI will trip and the spa will shut off.
2. Reset the GFCI breaker by switching the breaker to the full OFF position, wait a moment, then turn the breaker back on. The spa should have power again.

240V GFCI and Wiring Requirements

All 5100 and 6200 control systems are set at the factory to run on the low power setting for 40 amp operation. This is the default setting. Spa owners can have their installer change this setting so the spa will run on high power for 50 amp operation.

Warning: Never set a spa to run on high power without installing a properly rated GFCI.

Spa Model	GFCI Required	Wires Required
4050 control box (5100 and 6200 systems) Power saver mode -- this is the factory default setting	One 40 amp GFCI	Four #8 AWG copper wires
4050 control box (5100 and 6200 systems) High power setting -- See configuration instructions below.	One 50 amp GFCI	Four #8 AWG copper wires
9800 control box (except Ultimate Fitness spas -- see below)	One 50 amp GFCI	Four #8 AWG copper wires
5060 control box (6300 system) Default high power setting -- See configuration instructions on page 6.	One 60 amp GFCI	Four #8 AWG copper wires
Ultimate Fitness Spas:		
Fitness spa with 5.5 kW heater: <i>F854, F1257, FP2400</i>	One 50 amp GFCI	Four #8 AWG copper wires
Fitness spa with 11 kW heater: <i>F1257, F1455, FP1655, FP2500, FP2400</i> SEE PAGES 6 AND 7 FOR INSTALLATION DIAGRAM.	Service 1: One 60 amp GFCI	Service 1: Four #8 AWG copper wires
	Service 2: One 30 amp GFCI	Service 2: Three #8 AWG copper wires
Fitness Pro 4700 spa SEE PAGES 6 AND 7 FOR INSTALLATION DIAGRAM.	Service 1 (swim side): One 60 amp GFCI	Service 1: Four #8 AWG copper wires
	Service 2 (swim side): One 30 amp GFCI	Service 2: Three #8 AWG copper wires
	Service 3 (spa side): One 40 amp GFCI	Service 3: Four #8 AWG copper wires

4050 System High Power Configuration Applies to 5100 and 6200 systems

To operate the spa in high power mode, ensure the following steps are performed before starting your spa:

- When installing the electrical system, use a 50 amp GFCI. Follow the GFCI wiring diagram on the next page.
- Have your dealer or installer set dip switch #10 to the OFF position on the circuit board as shown at right.

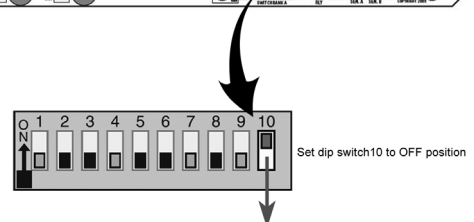
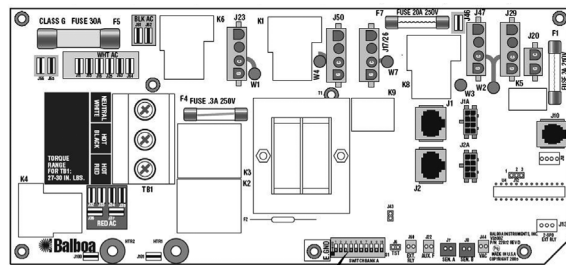

5060 System High Power Configuration

Applies to 6300 systems

The 6300 control system requires higher power than other 240V systems. Dip switch #10 is factory set in the ON position. This causes the heater to shut off when any pump is running in high speed. To allow the heater to continue operating, dip switch #10 must be set to the OFF position.

To ensure your spa functions properly, ensure the following steps are performed before starting your spa:

- When installing the electrical system, use a 60 amp GFCI. Follow the GFCI wiring diagram on the next page.
- Have your dealer or installer set dip switch #10 to the OFF position on the circuit board as shown at right.

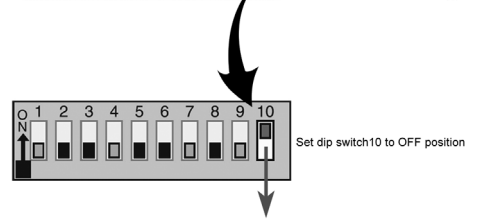
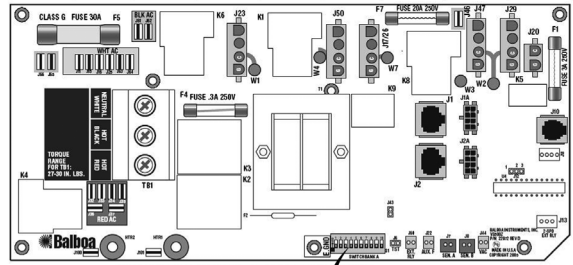

Electrical Installation for 11 kW Heater

This applies to Fitness spas with the 11 kW heater only.

Two electrical services are required to heat the swim side of the Fitness Spa.

SOURCE #2
 INPUT POWER 30AMPS
 3 WIRES
 HOT, HOT, GROUND
 AWG #8

SOURCE #1
 INPUT POWER 60 AMPS
 4 WIRES
 HOT, HOT, NEUTRAL GROUND
 AWG #8

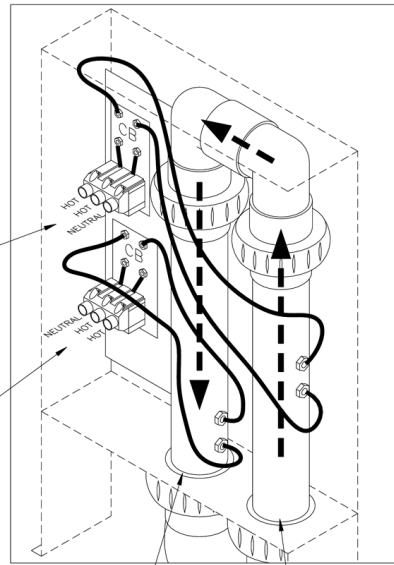

5.5 KW H OUT

5.5 KW H IN

GFCI Wiring Diagram

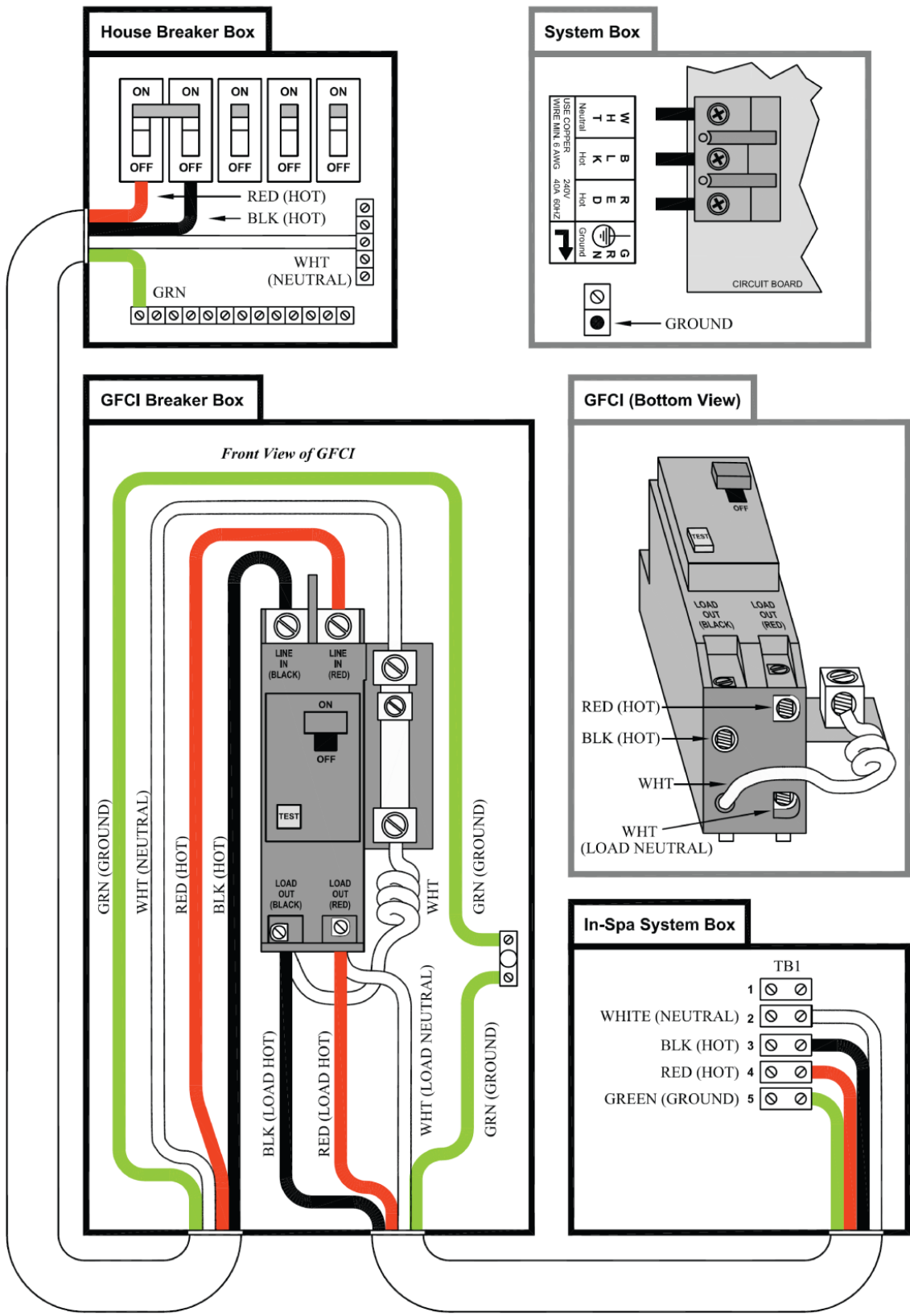

Gas Heater Hook up

Ultimate Fitness Series spa owners may buy and install a separate gas heater and pump for use with their spa. This option may be purchased separately from your local distributor.

Spa owners are responsible for ensuring installation of their gas heater conforms to local, state, and federal regulations. The electrical and gas installation must be performed by contractors and approved by a local building / electrical inspector. Failure to do so may void your warranty.

All Ultimate Fitness Series spas are plumbed with a gas heater ready union located inside the cabinet at either the front or rear, depending on the model. (See the figures below and at right.) Properly installed, they can be attached to an external gas heater. Customers are responsible for creating openings in the panel to accommodate the lines and wiring. The gas heater should be located not less than 10 feet and no more than 25 feet away from the spa.

To connect the plumbing for an external gas heater:

1. Disconnect the ready union.
2. Cut off both sides of the union and discard it.
3. Create two 2½" diameter holes through the spa panel.
4. Use two 2" couplings to connect the hoses to 10' - 15' 2-3/8" diameter PVC lines.
5. Connect PVC lines to the gas heater.

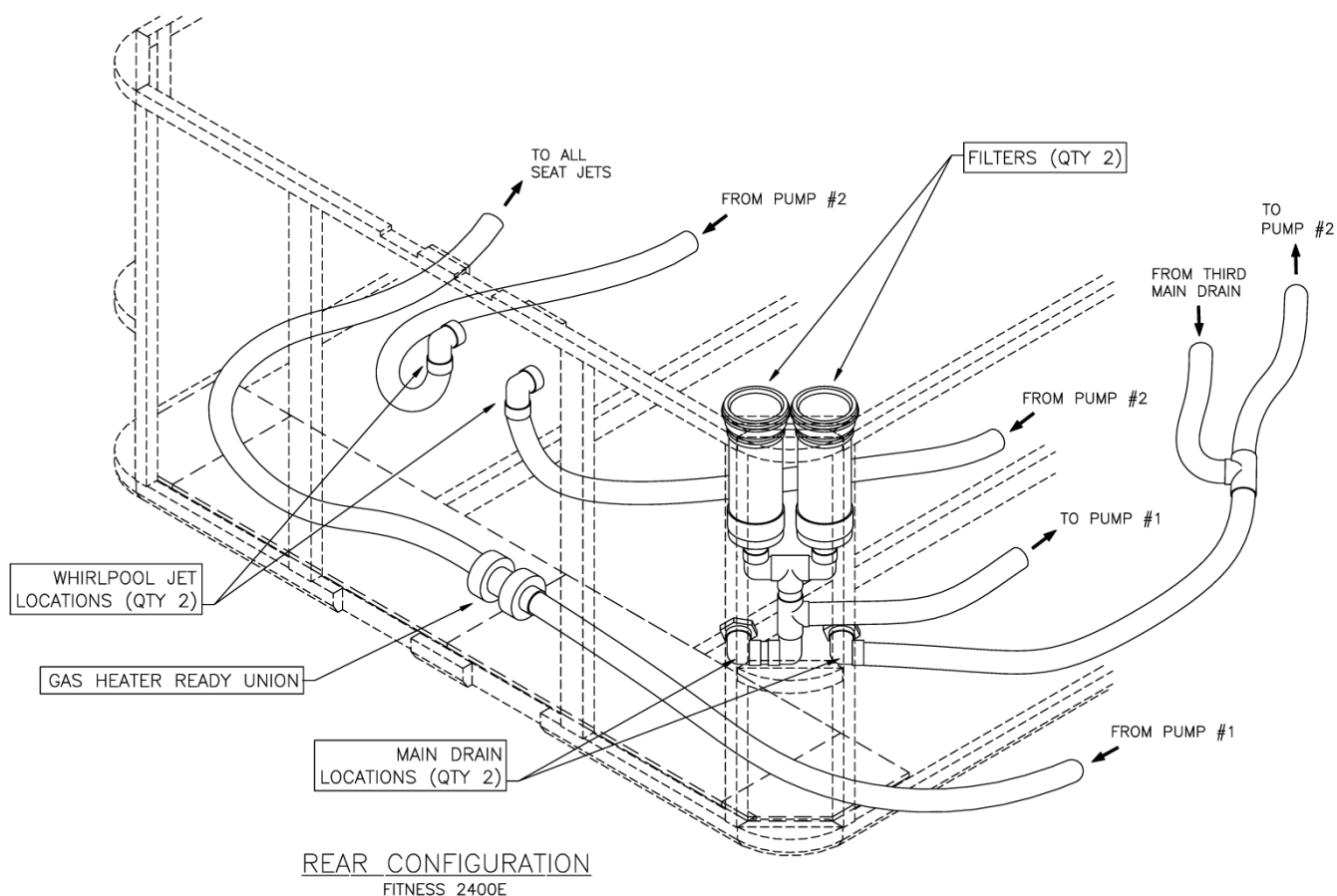

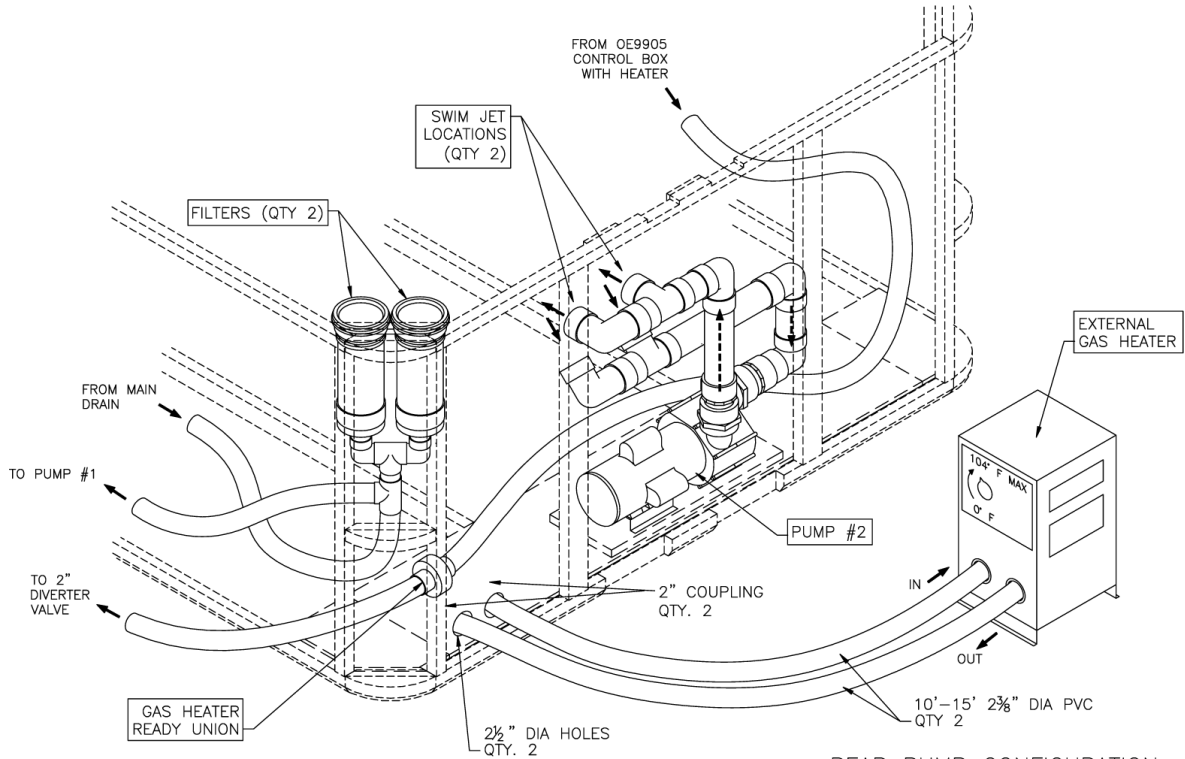

REAR PUMP CONFIGURATION
FITNESS PRO 2500E

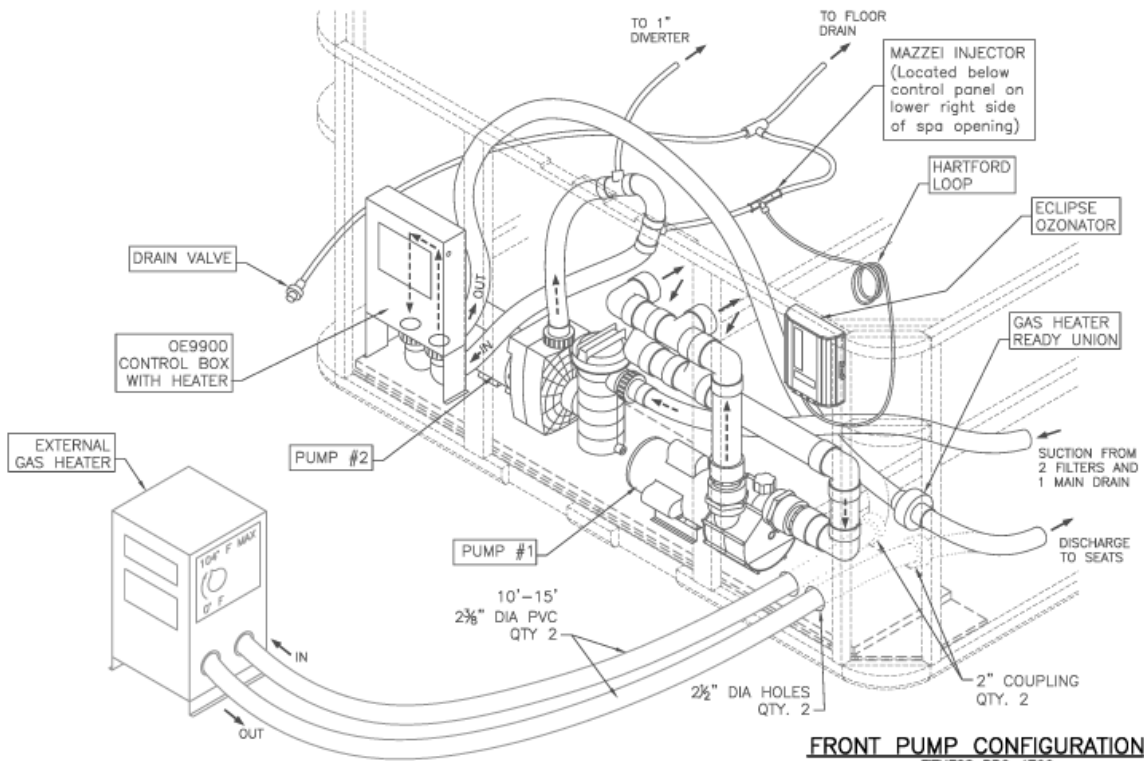

FRONT PUMP CONFIGURATION
FITNESS PRO 4700

Filling and Powering Up Your Portable Spa



Never fill your spa with soft water.

Soft water makes it impossible to maintain the proper water chemistry and may cause the water to foam, which will ultimately harm the finish of the spa and void your warranty.

1. Once the spa has been placed on an approved surface and has been correctly wired by a licensed electrician, inspect all plumbing connections in the equipment area of your spa. Ensure that these connections are secure and that they did not loosen during shipment.
2. If equipped, open all gate valves in the equipment area. Before operating the spa, these valves must be in the up or "open" position.



VERY IMPORTANT!

Never run the spa with the gate valves closed or without water circulating for long periods of time. Be careful not to over-tighten the plumbing fittings.

3. Remove the cartridge from filter canister.
4. Place a garden hose in the filter canister and fill your spa with **regular tap water** about six inches from the top.



VERY IMPORTANT!

Always fill the spa through the filter canister! Failure to do so may cause air to be trapped in the filtration system and prevent the pumps from operating properly.

5. Presoak the filters in spa water.



VERY IMPORTANT!

You must presoak the filters before inserting them in the filter canister. Dry filters can allow air into the filtration system which can cause pump failure.

6. (For owners of the automatic bromine generator) Make sure the dial on the face of the bromine generator unit is turned to the OFF position.
7. Once the water is at the correct level and air is bled, turn on the power at the GFCI breaker. (Ensure that the 120V spas are connected to the proper electrical outlet.)

Note: Depending on the model, when the power is turned on to the spa, the controls will perform a diagnostic check for approximately five minutes. When the diagnostic is complete, the spa will automatically operate at filter speed and continue heating until the spa water temperature reaches the default temperature of 100°F.

8. If no water is flowing when the pump is running, there could be an air pocket at the suction side of the pump. Shut off power to the spa and loosen the pump union on the suction side of the pump to bleed the air. When air is bled, turn power back on.
9. Install the pre-soaked filters into the filter canister.

The spa is now ready for use.

Priming the Pump

New spa owners often have difficulty the first time they start their spa and the pump fails to prime. This can be frustrating, but these simple instructions can help you.

Sometimes air can become trapped in the pump while filling the spa. You will know this has happened when after you have filled and started the spa, the pump does not seem to function. You will hear the pump operating, but no water will be moving.

There are two methods of priming the pump.

The first method will remove small air bubbles trapped in the pump.

1. Turn the spa on and wait for PR (Priming Mode) to appear on the topside display.
2. Press the JETS1 button to turn on the pump and let it run for 10 seconds. The pump should be running in low speed.
3. Press the JETS1 buttons again and let the pump run in high speed for 10 seconds.
4. Press the JETS1 button again to turn off the pump. The pump should be left in the off position for 10 to 15 seconds.
5. Repeat steps 1 through 4 until water is flowing through all the jets and all air is removed from the plumbing.

The second method will remove a large air lock within the pump.

1. Using a Phillips screwdriver, remove the front panel from the spa and locate the pump.
2. While the spa is operating, turn the bleeder valve counter clockwise with a small pair of pliers or a flat head screwdriver until the air has been released from the pump.
3. If this is unsuccessful, loosen the white union nut on side of the pump with channel locks. When air is bled out, tighten the nut and set the pump on high speed.



The pump will not work properly while air is trapped in it. Continuing to operate the pump in this way will cause damage.

Whenever you fill your spa, fill it through the filter canister and make sure all jets are open.

Note: If you press the **Temp** button any time during Priming Mode, it will exit that mode and begin Standard Mode.

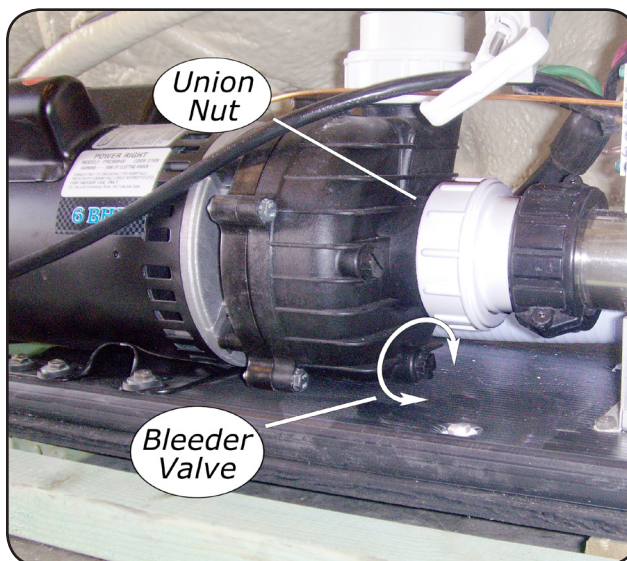

Operating Your Spa

5100, 6200 and 6300 Electronic Control Operation

These instructions will describe features and options that your particular spa may not be equipped with.



5100 Control Panel (one and two pump systems)



6200 and 6300 Control Panel

Initial Start up

When first powered up, your spa will perform a self-diagnostic check and go into priming mode. The topside will display **PR** to indicate this. Priming mode will be active for less than five minutes.

Sometimes the pump fails to prime, especially when spa owners do not fill their spas through the filter canister. You can avoid priming problems by following these steps during priming mode.

1. Press the JETS button to turn on the pump and let it run for 10 seconds. The pump should be running in low speed.
2. Press the JETS buttons again and let the pump run in high speed for 10 seconds.
3. Press the JETS button again to turn off the pump. The pump should be left in the off position for 10 to 15 seconds.
4. Repeat steps 1 through 3 until water is flowing through all the jets and all air is removed from the plumbing.

When the spa has finished priming, the heater will be activated and the water temperature will be maintained in standard mode. The spa will heat to 100°F (37.5°C) at start up until the set temperature is changed as described below.

Temperature Adjustment

(Range 80°F to 104°F, 26°C to 40°C)

The electronic control panel displays the actual water temperature in degrees Fahrenheit. The displayed temperature will only be current after the pump has been running for at least two minutes.

To display the temperature that the spa is set to:

- Press the **Temp** button. The temperature setting will flash.
- While the display is flashing, each time you press **Temp** button, the set temperature will change up or down one degree.
- If the desired temperature is opposite of the direction each press of the button is making, release button, allow display to stop flashing and then press **Temp** button to change temperature the other direction.

Standard, Economy and Sleep Heating Modes

Your new spa is equipped with a heating feature that gives you complete control of the heating system. When the spa is powered up, it will automatically start in standard heating mode.

- **St** will light briefly on the main display. In this mode, the heating system will automatically maintain the set spa temperature. In the economy-heating mode, the heating system will only activate during filtration times.
- **Ec** will display solid if temperature is not current and will alternate with spa temperature if measured temperature is current.
- Economy mode will heat the water to the set temperature while Sleep mode, indicated by a **SL** on the main display, will also only activate the heater during the filtering cycles but will only heat the water to within 20°F (10°C) of the set temperature. Like Economy mode, **SL** will display solid when temperature is not current and will alternate with actual temperature when it is current.

NOTE: Displayed temperature will only be current after the pump has been running for at least two minutes.

Switching Modes

- Press **Temp** button followed by the **Light** button.
- Press the same sequence to switch to the next mode.

Jets

Press the **Jets** button:

- Once to activate low speed pump.
- Twice to activate high speed.
- Three times to turn pump off.

Light

Press the **Light** button to turn on the light. Press it once again to turn the light off. All optional lighting such as the control panel light and cabinet perimeter lighting is controlled by the **Light** button and will turn on and off with the spa light.

Option

Press the **Option** button to turn on the pump 2. Press it once again to turn off the pump 2 (6200 control only).

6300 Control - Pump 2 and Pump 3 Sequence

- Press **Option** button once to activate high speed pump 2.
- Press **Option** button twice to activate high speed pump 3 and high speed pump 2.
- Press three times to activate pump 3 high speed only.
- Press four times to turn pumps off.

“Green Pack” Operation

Spas with the “Green Pack” option require approximately 20% less power to operate. Once the spa is properly installed, it does not require any special operation. This is for your information only.

When JETS 1 is pressed, the heater will operate at 220V. When JETS 2 or OPTION is pressed (depending on which control panel you have), the heater will automatically switch to operate at 110V.

With the “Green Pack”, your spa will never use more than 30 amps while in operation.

Automatic Time outs

These features will automatically turn themselves off during periods of continuous use:

- Low speed pump After 4 hours
- High speed pumps After 15 minutes
- Optional circulation pump After 15 minutes
- Optional turbo After 15 minutes
- Spa light After 4 hours

Setting Filtration Cycles

Your spa is programmed to filter twice a day. The first cycle will begin 6 minutes after the spa is turned on and the second cycle 12 hours later. The factory has programmed the cycle to last for 2 hours but this can be switched to 4, 6, or 8 hours depending on your requirements. To set filtration time, turn off the power to the spa at the time of day you would like one of the filtration cycles to begin then turn back on after 30 seconds. When power has been restored, press the **Temp** button then the **Jets** button. Press **Temp** button again to change the filtering cycle duration. When desired duration is selected press the **Jets** button to exit.

At the beginning of each filtering cycle the Turbo system will run for approximately 30 seconds. The low speed pump will run for the duration of the filtering cycle and if an Ozone system is installed it will be activated. During filtering, **FC** will appear on the main display.

9800 Electronic Control Operation

These instructions will describe features and options that your particular spa may not be equipped with.



Initial Start up

When first powered up, your spa will perform a self-diagnostic check and go into priming mode. The topside will display **PR** to indicate this. Priming mode will be active for less than five minutes.

Sometimes the pump fails to prime, especially when spa owners do not fill their spas through the filter canister. You can avoid priming problems by following these steps during priming mode.

1. Press the JETS 1 button to turn on the pump and let it run for 10 seconds. The pump should be running in low speed.
2. Press the JETS 1 buttons again and let the pump run in high speed for 10 seconds.
3. Press the JETS 1 button again to turn off the pump. The pump should be left in the off position for 10 to 15 seconds.
4. Repeat steps 1 through 3 until water is flowing through all the jets and all air is removed from the plumbing.

When the spa has finished priming, the heater will be activated and the water temperature will be maintained in standard mode. The spa will heat to 100°F (37.5°C) at start up until the set temperature is changed as described below.

Temperature Adjustment

(Range 80°F to 104°F, 26°C to 40°C)

The start-up temperature is set at 100°F (37.5°C). The last measured temperature is constantly displayed on the control panel. Note that the last measured spa temperature is displayed. The displayed temperature will be updated when the pump has been running for at least two minutes.

Press the "UP" or "DOWN" buttons once to display the set temperature. Each time either button is pressed again, the set temperature will increase or decrease depending on which button is pressed. After three seconds, the control panel will automatically display the last measured spa temperature.

Time

When time hasn't been programmed, the "TIME" icon flashes. To set the time, press the "TIME" button and then the "MODE/PROG" button. Use the "UP" and "DOWN" buttons to adjust time. See the next page for more detailed instructions.

Standard, Economy, Sleep, and Standby Modes

Mode/Prog: This button is used to switch between standard, economy, and sleep modes.

1. Press "MODE/PROG" to enter mode programming.

2. Press the "DOWN" button to cycle through to the desired mode.
3. Press "MODE/PROG" to confirm selection.

Standard Mode: This is programmed to maintain the desired temperature. Note that the last measured spa temperature displayed is current only when the pump has been running for at least two minutes. The "STAND" icon will display until the mode is changed.

Economy Mode: Economy mode heats the spa to the set temperature only during filter cycles. The "ECON" icon will display until the mode is changed. Pressing the "JETS 1" button while in economy mode puts the spa in standard-in-economy mode, which operates the same as standard mode but reverts back to economy mode automatically after one hour. During this time, pressing the "MODE/PROG" button will revert to economy mode immediately.

Sleep Mode: Sleep mode heats the spa to within 20°F (11°C) of the set temperature only during filter cycles. The "SLEEP" icon will display until the mode is changed.

Standby Mode: Pressing "Warm" or "Cool" then "JETS 2" will turn off all spa functions temporarily. This is helpful when changing a filter. Pressing any button resets the spa.

Jets 1

Press the "JETS 1" button once to turn pump 1 on or off and to shift between low and high speeds if equipped. If left running, the low speed turns off after two hours and the high speed turns off after 15 minutes. On non-circulation systems, the low speed of pump 1 runs when the blower or any other pump is on. It may also activate for at least two minutes every 30 minutes to detect the spa temperature and then to heat to the set temperature if needed, depending upon the mode. When the low speed turns on automatically, it cannot be deactivated from the panel; however, the high speed may be started.

Jets 2

Press the "JETS 2" button once to turn pump 2 on or off and to shift between low and high speeds if it is a two-speed pump. If left running, the pump will turn off after 15 minutes.

Option

This is an optional feature. Press the "OPTION" button to turn the optional equipment on and off. If left on, the equipment will automatically turn off after 15 minutes.

Light

Press the "LIGHT" button to turn the spa light on and off and to shift between dim and bright settings if your light is dimmable. On dim, the control panel will show the center circle plus one quarter of the light beams. Half of the light beams will show on medium brightness, and all of the light beams will show on bright.

Invert

Press the "INVERT" button to change the numbers in the display to read upside down. Another press returns the display to the right-side-up position. This enables you to read the display while you are in the spa.

Locking the Panel

To lock the panel:

- Press "TIME", "JETS 1", and the "UP" button within three seconds. When locked, the panel will display "LOCK". All buttons are frozen except the "TIME" button.

To unlock the panel:

- Press "TIME", "JETS 1" then the "DOWN" button within three seconds.

Setting the Temperature Lock

To activate the temperature lock:

- Press the "UP" or "DOWN" button, "TIME", "JETS 1", then the "UP" button within three seconds. The panel will display "TEMP LOCK" when the set temperature is locked.

To unlock the set temperature:

- Press the "UP" or "DOWN" button, "TIME", "JETS 1", and then the "DOWN" button.

Circulation Pump

This is an optional feature. The circulation pump will come on when the system is checking temperature, during filter cycles, during freeze conditions, or when another pump is on.

Preset Filter Cycles

There are two filter cycles per day. The start and end times of each cycle are programmable. To program, set the time as instructed above, then press "MODE/PROG" to advance to the next setting (or to exit after the last setting). The default filter cycles are as follows:

- The first filter cycle is automatically activated at 8:00 AM and operates the pump until 10:00 AM.

The "FILTER 1" indicator icon will light when filter 1 is running.

- The second filter cycle is automatically activated at 8:00 PM and operates the pump until 10:00 PM. The "FILTER 2" indicator icon will light when filter 2 is running.

The pump and the ozone generator will run during filtration. At the start of each filter cycle, the blower will run on highest speed for 30 seconds to clean out the air channels. The lowest speed of pump 2 and pump 3 will run for five minutes. In the event of power loss or shut down, the time of day will need to be reset for filter cycles to run according to your desired programming.

Clean up Cycle

When the pump or blower is turned on by a button press, a clean-up cycle begins 30 minutes after the pump or blower is turned off or times out. The pump and the ozone generator will run for one hour.

Ozone

This is an optional feature. On most systems, the ozone generator (if installed) runs during filter cycles (except when pump 1 is operating at high speed on a non-circulating system) and during clean-up cycles. On some systems, the ozone generator operates whenever the pump runs. If your system is configured with the optional ozone disable feature, the ozone generator will turn off for one hour any time a function button ("JETS 1", "JETS 2", "OPTION" etc.) is pressed.

Freeze Protection

If the temperature sensors detect a drop to 44°F within the heater, the pump automatically activates to provide freeze protection. The equipment stays on until four minutes after the sensors detect that the spa temperature has risen to 45°F or higher. In colder climates, an optional additional freeze sensor may be added to protect against freeze conditions that may not be sensed by the standard sensors. Auxiliary freeze sensor protection acts similarly except with the temperature thresholds determined by the switch and without a four-minute delay in turnoff.



"Sounds Good" System Operation

The "Sounds Good" system is available on 9800 controls only.

When you press the button once, it activates the sound system. You will hear a unique sound for each button you press on the control panel.

The "Sounds Good" system plays sounds in three modes and will cycle in this order each time you press the button on the SOUNDS GOOD panel:



- Once All sounds play at full volume
- Twice All sounds play at half volume
- Three times One sound plays for all controls
- Four times All sounds are off

Auxiliary Control Panels

Standard configuration (9800)

Jets 1
Light Jets 2
Option



Spa Models with 3-pump system (9800)

Jets 1
Jets 3 Jets 2
Option



Air blower control (9800)



Two button jets control (6200/6300)



Periodic Reminder Messages

Press the "Mode" button to reset a displayed reminder.

Message	Frequency	Action Required
rPH	Every 7 days	Test and adjust chemical levels per manufacturer's instructions.
rSA	Every 7 days	Test and adjust chemical levels per manufacturer's instructions.
rCL	Every 30 days	Remove, clean, and reinstall filter per manufacturer's instructions.
rtg	Every 30 days	Test and reset GFCI per manufacturer's instructions. Drain and refill spa per manufacturer's instructions.
rdr	Every 90 days	Drain and refill spa per manufacturer's instructions.
rCO	Every 180 days	Clean and condition spa cover.
rCH	Every 365 days	Install a new filter.

Diagnostic Messages

Message	Meaning	Action Required
No message on display	1) Spa temperature is unknown. 2) Spa is in Economy or Sleep mode. 3) Power has been cut off to the spa.	1) After pump has been running for 2 minutes temperature will be displayed. 2) In Economy or Sleep mode, the pump may be off for hours outside a filter cycle. If you wish to see the current spa temperature, either switch to Standard mode or turn Jets1 on for at least two minutes. 3) The control panel will be disabled until power returns. Spa settings and time of day will be preserved for 30 days with a battery back-up.
BUF	Internal problem detected.	Repair required. Contact your dealer or service organization.
dr	Insufficient water detected in heater. Spa will be shut down for 15 minutes.	Check water level in spa. Refill if necessary. Make sure pumps are primed and filter cartridges are clean. Press any button to reset or wait 15 minutes and spa will automatically reset. If message spa does not reset, call your dealer or service organization.
dry dY	Insufficient water detected in heater. Spa is shut down. (Displays on third occurrence of dr message.)	Follow directions for dr message and press any button to reset spa. Spa will not automatically reset when dry or dY is displayed.
Ec	Indicates heater is in Economy Mode.	None.
--F or --C	Temperature unknown	After the pump has been running for two minutes, the temperature will be displayed.
HL HFL	A difference in readings between temperature sensors has been detected indicating a possible water flow problem.	Make sure spa is filled to proper level and that pumps are primed and filter cartridges are clean. If message does not reset, call your dealer or service organization.
IC ICE	Potential freeze condition detected.	No action required. The pumps and the blower will automatically activate regardless of spa status.

Message	Meaning	Action Required
LF	Persistent low flow problems. Heater is shut down, but other spa functions continue to run normally. Displays on the fifth occurrence of the HL or HFL message within 24 hours.	Follow action required for HL or HFL message. Heating capacity of the spa will not reset automatically. Press any button to reset.
OH OHS	Overheat protection. The spa has shut down. One of the sensors has detected that the spa water is 110°F.	DO NOT ENTER THE WATER. Remove the spa cover and allow water to cool. At 107°F, the spa should automatically reset. If spa does not reset, shut off the power to the spa and call your dealer or service organization.
HH OHH	Overheat protection (spa is shutdown). One sensor has detected 118°F (48°C) at the heater.	DO NOT ENTER THE WATER! Remove the spa cover and allow spa to cool below 107°F (42°C). Press any button on the topside display to reset spa. If spa will not reset after spa has cooled, turn off power for approximately 30 seconds and then turn power back on. If display message is repeated then shut the power off to the spa and call your dealer or service organization.
Pr	When your spa is first actuated, it will go into priming mode.	The priming mode will last for up to four minutes and then the spa will begin to heat and maintain the water temperature in the Standard mode.
SF	Safety Suction. Spa is shut down.	The display will show SF when a vacuum switch closes. All functions will turn off and the system will be disabled until a panel button is pressed.
SL	Indicates heater is in Sleep Mode.	None.
SA Sb SNA Snb	Spa is shut down. The sensor that is plugged into the sensor "A" or "B" jack is not working.	If the problem persists, contact your dealer or service organization. (May appear temporarily in an overheat situation and disappear when the heater cools.)
Sns Sn	Sensors are out of balance. <ul style="list-style-type: none"> If this is alternating with the temperature, it may just be a temporary condition. If the display shows only this message (periodically blinking), the spa is shut down. 	Contact your dealer or service organization.
ST	Indicates heater is in Standard Mode.	None.
Stby	Pressing a button combination on the user panel has activated Standby Mode.	Press any button to leave Standby Mode and return to normal operation.

Electrical Power Efficiency

Your new spa comes equipped with an electric heater. Following the directions listed below will ensure the most efficient operation:

NOTE: This method is only for spa usage under two hours a week.

- Keep the spa's operating temperature 5°F below the desired usage temperature when not in use. One or two hours before use, set the temperature to the desired temperature.
- If the spa usage exceeds two hours a week, the set temperature should remain at the desired usage temperature.
- The air venturis should be used sparingly. When open, water temperature drops quite rapidly and can also dissipate chemicals.

Allowing the water temperature to lower more than 10°F below the desired usage temperature and reheating it prior to usage will cause the heater to operate longer than it normally would maintaining the desired temperature. Doing this will increase your operating cost and makes your heater work more than necessary.



Jets

Almost all of the jets in your spa are adjustable. Rotating the face of an adjustable jet to the left (counter-clockwise) will decrease the amount of water flow through the jet. Rotating the face of an adjustable jet to the right (clockwise) will increase the amount of water flow through the jet. (See example shown below.)

Neck jets adjust in the opposite directions (counter-clockwise to increase, clockwise to decrease).

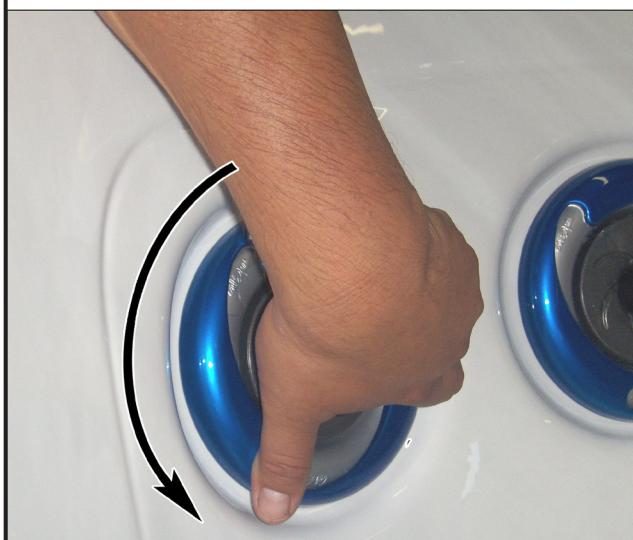

Diverter Knobs

Diverter knobs are 1" and 2" knobs located around the top of your spa. They allow you to divert water through jets from one side of the spa to the other, or in most cases from floor jets to wall jets. This is accomplished by rotating the diverter knob to the left (counterclockwise), decreasing the amount of water flow through a section of jets. To increase the amount of water flow through the other section of jets, rotate the handle to the right (clockwise).



Waterfalls

Some spa series include optional waterfalls. When the booster pump is on, turn the knob near the waterfall, or rotate the dial on top of the waterfall. Water will immediately start flowing through it.

Air Venturis

Air venturis are the 1" knobs located around the top of your spa. Each one will let you add a mixture of air with the jet pressure. This is accomplished by rotating the air venturi knob to the left (counterclockwise) to increase the amount of airflow through the jets. To decrease the amount of airflow through the jets, rotate the handle to the right (clockwise).



Adjustable Therapy System

Pump On/Off

This button allows the user to turn on and off the ATS seat pump. Press this button once to turn the pump on. Once on, the green LED light on the control panel will illuminate, indicating that the system is operational. To turn off the pump, press the "PUMP ON/OFF" button a second time. Note: The pump must be on prior to operating any other features of this system.

Pulse Mode

This button allows the user to turn the ATS massage control on and off. Press the pulse button once to turn on the massage control. Once pressed, the orange LED in position number 1 will light, indicating the number one pulse mode. Each press of either the up or down button will move the orange LED up or down to the next pulse mode.

Note: Allow one second between each button press. Pressing the button quickly may cause improper operation. To turn the pulse mode off and return to normal pump operation, press the "PULSE MODE" button a second time.

Up

This button allows the user to cycle up from one through seven massage modes one at a time. Each mode offers a different pulsating massage. Some modes are faster than others, so just cycle through them to find the massage you like best.

Down

This button allows the user to cycle down through all seven massage modes, one at a time.

Time Reset Mode

Pulse mode will normally run for 15 minutes then automatically shut off. For another 15-minute session, press the "PUMP ON/OFF" button and the "PULSE MODE" button. A green LED will blink and the pump will run on high-speed mode as part of a 15-minute cool down period. After that, the pump will stop automatically and the green LED light on the panel will continue to blink for one minute then shut off automatically. After the second 15-minute session, the system will run through a cool down cycle for up to two hours. In this cool down mode, the user will only be able to operate the pump (by again pressing the "PUMP ON/OFF" button). However, the massage mode will remain off until the cool down mode is completed.



Pulse Mode System

Pulse mode system will shut off for two hours unless reset by the following procedure. During this time the pump will run at a maximum speed.

- In the off position, press the "PULSE MODE" button once.
- The green power light will flash to indicate reset.

Wireless Spa Monitor

The wireless spa monitor allows you to monitor and change your spa's activity from a distance. The table below describes each button's function.

Light	Operates spa light and LED mood lighting
Temp	Display or adjust the set temperature control
Jet 1	Turn on or off jet 1
Mode	Switch between Standard, Economy, and Sleep Modes



LED Perimeter Lighting

Press the LIGHT button on the topside control panel to turn the spa light on. If your spa has perimeter LED lights, they will also light up at the same time as the spa light.

The perimeter lights operate in three modes:

- 1. **Cycle:** The first time you press the LIGHT button, the lights will cycle through all the colors in this order:

- White
- Cyan
- Magenta
- Blue
- Yellow/green
- Green
- Red

To cycle through the different color choices, press the button repeatedly. Each time you press the button, you advance to the next color.

- 2. **Flashing white:** When you have cycled through all the colors, the next time you push the LIGHT button, the LED lights will flash white.
- 3. **Fading cycle:** The next time you push the LIGHT button, the lights will gradually fade from one color to the next in the order shown above.

Spas with exterior corner LED lighting work in the same modes as described above but do not light up when the interior perimeter lights are yellow/green, green or red.



Clear Water Plan

This section is intended for new spa owners with no experience with water chemistry. Everyone's experience with maintaining water quality is different, but there are some general concepts you need to know.

Water maintenance is not difficult, although it requires regular attention. The most important thing to understand about taking care of your spa water is that preventive action is much easier than correcting water quality issues.

The Key to Clear Water

Excellent water quality is a simple matter of four things:

Regularity

Clear water requires regular maintenance. Establish a routine based on a regular schedule for your spa water maintenance.

Maintaining your water quality helps the enjoyment of your spa and extends your spa's life by preventing damage from neglect and chemical abuse.

See page 30 for the schedule of recommended maintenance.

Sanitation

Sanitizers kill bacteria and viruses and keep the water clean. A low sanitizer level will allow microbes to grow quickly in the spa water.

We recommend using either chlorine or bromine as your sanitizer.

Spa owners with a Cal Zone 2000 ozonator or a Cal Clarity bromine generator also need to add sanitizer, although their requirements are different.

See page 26 for learn how to use sanitizer.

Contents of this section:

- Testing and Adjusting Spa Water
- Sanitation
- Filtration
- Bather Load
- Starting the Spa with Fresh Water
- Maintenance Schedule
- Cal Zone Quest Ozonator
- Cal Clarity Bromine Generator
- Troubleshooting Water Clarity Problems

Filtration

Cleaning your filter regularly is the easiest and most effective single thing you can do to keep your water clear.

A clogged or dirty filter will cause the heater and pump to work harder than they need to, possibly causing them to fail.

The spa's heating system will only function with the proper amount of water flow through the system.

See page 28 for filter cleaning instructions.

Chemical Balance

You will need to test and adjust the chemical balance of your spa water. Although this is not difficult, it needs to be done regularly.

Depending on your choice of sanitizer, you need to test the level of calcium hardness, total alkalinity, and pH. Spa owners with a Cal Clarity bromine generator also need to check total dissolved solids and phosphates.

See page 26 for learn how to balance your spa water.



Testing and Adjusting Spa Water

You have two types of testing methods to choose from:

- The **reagent test kit** is a method which provides a high level of accuracy. It is available in either liquid or tablet form.
- **Test strips** are a convenient testing method commonly used by spa owners.

Balancing the Total Alkalinity

Total alkalinity (TA) is the measure of the total levels of carbonates, bicarbonates, hydroxides, and other alkaline substances in the water. TA can be considered a "pH buffer". It is the measure of the ability of the water to resist changes in pH level.

The recommended total alkalinity is 80 - 120 ppm.

If the TA is too low, the pH level will fluctuate widely from high to low. Low TA can be corrected by adding Cal Spas "pH-Alkalinity Up".

If the TA is too high, the pH level will tend to be too high and may be difficult to bring down. High TA can be corrected by adding Cal Spas "pH-Alkalinity Down".

When the TA is balanced, it normally remains stable, although adding water with high or low alkalinity will raise or lower the TA level.

Balancing the Calcium Hardness

Calcium hardness (CH) is a measure of the total amount of dissolved calcium in the water. Calcium helps control the corrosive nature of the spa's water and is why soft water is not recommended. The low calcium content of soft water is very corrosive to the equipment and can cause staining of the spa shell.

The recommended calcium hardness is 150 - 200 ppm.

If the CH is too low, add Cal Spas "Liquid Hardness Increaser".

If the CH is too high, dilute the spa water with soft water or, if this is not available, add Cal Spas "Stain and Scale Defense".

When the CH is balanced, it normally remains stable, although adding soft water or very hard water will raise or lower the CH level.

Balancing the pH

The pH level is the measure of the balance between acidity and alkalinity.

If the pH is too low, it can cause corrosion of metal fixtures and the heating element. Low pH can be corrected by adding pH-Alkalinity Up.

If the pH is too high, it can cause scaling by allowing metals or minerals to form deposits and stain spa surfaces. High pH can be corrected by adding pH-Alkalinity Down.

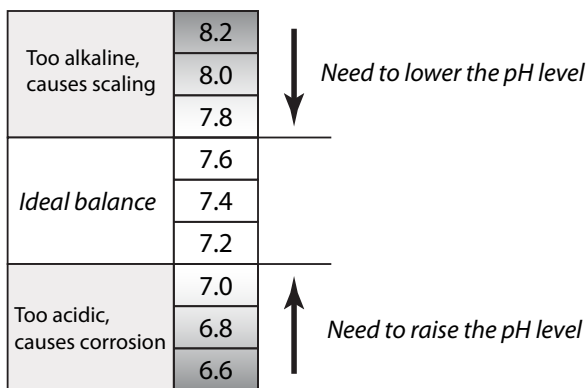

Testing For:	Ideal Range (ppm)		Chemicals To Use:	
	Minimum	Maximum	To Raise	To Lower
Total Alkalinity	80	120	pH-Alkalinity Up	pH-Alkaliity Down
Calcium Hardness	150	200	Liquid Hardness Increaser	Stain and Scale Defense
pH	7.4	7.6	pH-Alkalinity Up	pH-Alkaliity Down

Sanitation

After you fill your spa, you need to decide which chemical sanitizer you wish to use. Consult your Cal Spas dealer for the right decision with regards to your lifestyle and spa usage.

We recommend either **bromine** or **chlorine** as your sanitizer. Both work well when maintained regularly.



DO NOT use trichlor. Trichlor is very acidic and the hot temperature of the spa causes it to dissolve too quickly. It will cause damage to your spa and will void your warranty.

Sanitizers kill bacteria and other organic waste by breaking them down to non-harmful levels and are filtered out.

Make sure you follow all instructions and use only Cal Spas brand chemicals.

Whichever plan you decide on, follow it completely and don't take shortcuts. It will provide you with clean, safe, clear spa water with a minimum of effort. Spa owners with the Cal Zone Quest ozonator or the Cal Clarity bromine generator still need to use a chemical sanitizer. See page 31 for instructions on usage.

Using Chlorine as a Sanitizer

If you choose to use chlorine as a sanitizer, only use granulated chlorine, not liquid chlorine. We recommend you use only Cal Spas "Chlorinating Granules".

Once a week, check the chlorine level using either a test strip or a reagent kit. See the table on the following page for the ideal range.

Add one or two tablespoons of Cal Spas "Chlorinating Granules" to the spa water weekly. Note that chlorine dissipation rate will be faster at higher water temperatures and slower at lower temperatures.

When you add chlorine, open all of the jets and run the spa at high speed with the cover open for at least 30 minutes.

Follow the maintenance schedule on page page 30.

Using Bromine as a Sanitizer

Bromine is a very effective sanitizer that produces low chemical odors. Unlike chlorine, it can break down bacteria and other impurities to a safe level with a low burn-out rate.

Bromine is available in both granulated and tablet form. Use granulated bromine to establish your bromine base. Use tablets to maintain it. The filter cartridge provided with your spa has an internal chamber for bromine tablets. Do not use a floater.

When you begin with fresh water, add 2 ounces of Cal Spas Go Brom. Open all of the jets and run the spa at high speed. This is your base bromine level as the tablets will take a while to dissolve.

Add two ounces of Oxidizer Shock. Open all of the jets and run on high speed with the cover half open for at least 30 minutes.

Place three or four bromine tablets in the chamber inside the filter cartridge as shown in the figure at right.

Follow the maintenance schedule on page page 30.

Adding Sanitizer Tablets to the Chemical Chamber



Testing For:	Ideal Range (ppm)		Chemicals To Use:	
	Minimum	Maximum	To Raise	To Lower
Chlorine level				
Without ozonator	3.0	5.0	Chlorinating Granules	
With ozonator	2.0	4.0		
Bromine level				
Without ozonator	6.7	11.0	Go Brom	
With ozonator	5.7	10.0		
Note: The Cal Clarity bromine generator requires different water chemistry tests. See page 31 for instructions on its use.				

Shocking the Water

In addition to using a chemical sanitizer, you will periodically need to shock the water. Shocking the water helps remove burned-out chemicals, bacteria, and other organic material from your spa's water and improves your sanitizer's effectiveness.

Do not use chlorinating shock, which will damage your spa's jets and pump seals. The only shock you should use is Cal Spas Oxidizer Shock. It is an easy way to maintain either chlorine or bromine chemical plans.

For best results use the directions below.

Add one ounce of Cal Spas Oxidizer Shock:

- Once a week
- After heavy bather loads
- If water has a strong odor

Spa must be running with all of the jets on high for 30 minutes with the cover open. If necessary, repeat oxidizer shock in 30 minute intervals.



Chemical Safety

Read and follow all printed instructions listed on bottles and packages. Failure to follow chemical directions may result in serious injury, sickness, or even death.

Do not exceed chemical dosages as recommended in the Clear Water Plan or on chemical bottles and packages.

Never change chemical brands or types without completely draining, flushing and thoroughly cleaning the spa and cover first.

Never mix chemicals together.

Do not allow chemicals to come in contact with skin, eyes or clothing. Remove and wash clothing that

may have been exposed to chemical contact prior to wearing them again.

Inhaling or ingesting chemicals will cause serious injury, sickness, or even death.

Chemicals must be stored completely out of the reach of children in an area that is well vented, cool, and dry. Failure to provide a proper area for chemical storage may result in serious injury, sickness, fire explosion and even death. Do not store your chemicals inside the equipment area of your spa.

About the Pure XL Water Sanitizer

The Pure XL water sanitizer is an optional water purification system installed at the factory. It works 24 hours a day with the continuous filtration pump during normal operation of the spa. It eradicates germs in the water that are resistant to chlorine-based chemicals using high intensity UV light.

There are no settings to adjust and is virtually maintenance-free. Once a year the UV light needs to be replaced and the quartz sleeve needs to be cleaned.

This is not a user-serviceable item and maintenance must be performed by a spa technician. Have your service technician consult the manufacturer's instruction and service manual. (UV water purifier system is manufactured by Aqua Ultraviolet.)

Filter Cleaning

The filter is the part of your spa that removes the debris from the water and needs to be cleaned on a regular basis to maximize your spa's filtering performance and heating efficiency.

In addition to spraying off the filter weekly to remove surface debris, your filter should be deep cleaned periodically to dissolve scale and particles that get lodged deep within the filter fibers and impede the filtration process. Even if the filter looks clean, scale and particles can clog the fibers and prevent water from flowing through the filter resulting in the most common spa problem—no heat, caused by a dirty filter.

We recommend you clean your filter once a month and replace it once a year or as necessary.

1. Remove the filter by turning it counterclockwise, unscrewing the bottom threads, then pulling it up and out.
2. Place the dirty filter into a bucket of water deep enough to cover the filter. Add 8 oz of Cal Spas "Liquid Filter Cleaner" to the bucket of water.

Note: It is a good idea to keep a spare filter to use in the spa while the dirty filter is being deep cleaned. This way, you can rotate the filters and both will last longer.

3. Twist off the tablet tube and set it aside.
4. Soak the filter for a minimum of 24 hours.
5. Spray the filter with a water hose. Spray each pleat carefully.
6. Put fresh bromine in the tablet tube (if you use it as a sanitizer) and twist it back on top of the filter.
7. Reinstall the filter. Do not overtighten.

Bather Load

“Bather Load” is the term used to describe the number of people using a spa, combined with the length of usage, and the frequency of usage. All these factors have a great effect on the spa water. The higher the bather load, the more chemicals need to be added and a longer filtration time will be needed.

All versions of the Cal Spas Clear Water Plan are designed for spas with average bather load (3

to 4 people, 15 minutes of usage, three times a week at 100 degrees) If your bather load exceeds these guidelines, and you experience water quality problems, increase the amount of filtration first, (go to the next higher filtration number) then if water quality is still not adequate, consult the advice of your Cal Spas dealer for additional chemical or system recommendations. Be sure to give them your bather load information.

Starting the Spa with Fresh Water

This applies to all spa owners **EXCEPT** those with the Cal Clarity bromine generator. See instructions on page page 31 for bromine generator operating instructions and spa filling procedures.

We recommend you use Cal Spas chemicals only. Other brands of chemicals may have similar names and/or usage descriptions but due to manufacturing differences, use of other chemicals can increase the likelihood of under- or over-dosing the spa chemicals. Damage to the spa or spa’s components from improper chemicals or chemical usage is not covered under the spa’s warranty.

Prior to filling a spa for the first time, or after a routine draining, you will want to follow this start-up plan to extend water life and performance.

As with all chemical dosages listed in these Clear Water Plans, start-up dosages are intended for 500-gallon spas. Please adjust the chemical dosages to the capacity of your particular spa.

1. Clean the surface of the spa with Cal Spas “Multi-Purpose Cleaner”.
2. Apply a protective coat of Cal Spas “Fast Sheen” to the acrylic surface.

3. Fill the spa to the proper water level with normal tap water. (Do not use soft water.)
4. Use test strip and balance the spa water.
 - Adjust total alkalinity (acceptable range is 80-120ppm).
 - Adjust pH if necessary (between 7.2 to 7.8).
5. Pour in 16 oz of Cal Spas “Metal Protector” in the center of the spa.
6. Add Stain and Scale Prevention.
7. Add either chlorine or bromine (but not both).

Chlorine: Add two tablespoons of Cal Spas “Chlorine Granules” to the spa water.

Bromine: Add 2 oz of Cal Spas “Go Brom” to establish a bromine base.

Add 2 Cal Spas “Bromine Tablets” to bromine floater.

Set floater opening at #2.

8. Turn on jets for 15 minutes. Leave spa uncovered during this time.
9. Put cover on spa and allow to heat up to desired temperature.

Water level is very important to the operation of your spa. If the water level is too low or too high, your spa will not operate properly. The water level should be about six inches from the top when the spa is not being used.

Maintenance Schedule

Each time you refill the spa	Follow the section "Starting the Spa with Fresh Water".
Prior to each use	Test the spa water using either test strips a reagent test kit. Adjust chemical levels as necessary.
Once a week	Test the spa water using either test strips a reagent test kit. Adjust chemical levels as necessary.
Once a month	Deep clean your spa's filter. (Follow filter cleaning instruction at beginning of Clear Water Plan)
Every two to four months	<p>Drain and clean your spa with "Multi-Purpose Cleaner".</p> <p>Polish the acrylic surface with "Fast Sheen".</p> <p>Clean and treat spa cover, pillows, and Cal Select cabinet (if equipped) with "Cover Protector".</p> <p>Refill your spa, following the section "Starting the Spa with Fresh Water".</p> <p>If you are using the Cal Clarity Automatic Bromine Generator Clear Water Plan, add new sodium bromide to the water.</p>
Once a year	<p>Replace filter cartridges if the pleats appear frayed.</p> <p>If you use the Cal Zone Quest 2000 Ozonator, you will need to replace the ozone cartridge.</p> <p>If you use the Cal Pure UV water sanitizer, you will need to replace the UV lamp.</p>

We recommend that your spa water be changed every 4 to 6 months. You may find the need to change your spa water more frequently with heavy use. When empty, your spa should be cleaned with a non-abrasive cleaner, such as Cal Spas™ All Surface Cleaner, and then rinsed thoroughly.

Cal Zone Quest Ozonator

The Cal Zone ozone generator releases ozone into the spa water. You will still need to test for chlorine and occasionally replenish it to return the chlorine level to the baseline.

This plan and its chemical dosages are intended for spas equipped with the optional Cal Zone Quest 1000 / 2000 Ozonator or Del Zone Eclipse Ozonator. The chemical references are designed for Cal Spas chemicals only.

Start Up

1. Follow the spa start up procedures for chlorine Clear Water Plan.
2. Set the spa's filtration time for "F-4". This activates the ozonator and produces the ozone gas.

Note: Filtration time may need to be increased with heavy bather load.

Day One (Monday)

1. Test spa water using chlorine test strips. (You will need to use a small amount of chlorine as a supplemental sanitizer)
2. Based on the test strip readings:
 - Adjust total alkalinity (acceptable range of 80-120 ppm).
 - Adjust the pH if needed (range is between 7.2 to 7.8).
 - Add 1 tablespoon of chlorine granules.
 - The recommended level of Chlorine is 1-3 ppm.
3. Add 2 oz of "Stain and Scale Defense".
4. Remove dirty filter from the spa and rinse off.
5. Place your extra clean filter cartridge back into the spa.
6. Vacuum debris from the bottom of your spa with the spa vacuum.



Day Two (Friday)

1. Test spa water using chlorine test strips.
2. Based on the test strip reading:
 - Adjust total alkalinity, then the pH if needed.
 - Add 1 tablespoon of chlorine granules (if needed).
3. Add 2 oz of Cal Spas "Oxidizer Shock" to spa. Run spa for 15 minutes with cover off.
4. Replace cover.

Cal Clarity Bromine Generator

The Cal Clarity bromine generator automatically generates and releases free bromine into the spa water. You will still need to test for bromide and occasionally replenish it to return the bromine level to the baseline.



Start Up

1. Clean surface of spa with Cal Spas "Multi-Purpose Cleaner".
2. Apply a protective coat of Cal Spas "Fast Sheen" to the acrylic surface.
3. Fill spa to proper water level with normal tap water. Do not use soft water.
4. Use a test strip and balance the spa water:
 - Adjust total alkalinity (acceptable range is 80 to 120 ppm),
 - Adjust pH if necessary (between 7.2 to 7.8).
5. Pour in 16 oz. of Cal Spas "Metal Protector" in the center of spa.
6. Test for TDS (total dissolved solids).
 - The ideal range is 50 to 300 ppm.
 - TDS must be less than 500 ppm to start with.
7. Test for phosphates. Phosphate level should be below 200 ppb. Remove phosphates if necessary.
8. Determine the gallon capacity of the spa. Be accurate, because this determines the amount of TRU BLU that will be added. Consult the Cal Spas Pre-delivery Guide for spa gallons.
9. Power up the spa and make sure all the spa's pumps are set to high speed. Turn the dial on the face of the Cal Clarity Bromine Generator to OFF.
10. Sprinkle evenly over the surface of the spa one 2lb bottle of TRU BLU sodium bromide per 100 US gallons (370 liters) of water. Do not add too much!

Note: Each bottle of TRU BLU will raise TDS / conductivity amount approximately 500 ppm.

11. Allow spa to run for 15 minutes so the TRU BLU can dissolve completely before proceeding to the next step.
12. Use sodium bromide test strips (not bromine) and adjust sodium bromide level to 7.4 to 8.2 (equates to 1700 to 2500 ppm TDS level).
13. Add 2 oz of Cal Spas "Oxidizer Shock" to help burn out impurities in fill water.
14. Turn the dial on the bromine generator clockwise until the LED display reads 10.

15. This will initiate the build up of a bromine bank.
16. Set the filtration cycle to "continuous" (F-C) for the first 24 hours.
17. Put the cover on and allow the spa to heat to desired temperature.

Adjusting The Proper Bromine Levels

1. After start up, decrease the filtration cycle to F-4 and monitor the bromine level until it is within the recommended range.
2. Use bromine test strips to achieve a 3-5 ppm recommended level.

Note: It can take several days for the bromine level to stabilize because the fill water that was used sometimes contains contaminants that need to be neutralized, thereby using up the initial bromine that is generated.

3. Once the desired level has been achieved, turn the dial down until a maintenance setting is achieved. The common maintenance setting for an average bather load is 4.

When changing the setting, use bromine test strips to determine when you have reached the level you want.

Once a Week

1. Test spa water with bromine test strip.
2. Based on test strip readings:
 - Adjust alkalinity if necessary.
 - Adjust pH if necessary.
 - Increase / decrease bromine production with dial if required.
3. Remove dirty filter from the spa and rinse off.
4. Place your clean, extra filter cartridge back into the spa.
5. Add 2 oz of Cal Spas "Oxidizer Shock" to spa. Run spa for 15 minutes
6. Vacuum debris from the bottom of your spa with the "Spa Vacuum".
7. Replace cover.

Troubleshooting Water Clarity Problems

Problem	Probable Causes	Possible Solutions
Cloudy Water	<ul style="list-style-type: none"> • Dirty filter • Excessive oils / organic matter • Improper sanitization • Suspended particles / organic matter • Overused or old water 	<ul style="list-style-type: none"> • Clean filter • Shock spa with sanitizer • Add sanitizer • Adjust pH and/or alkalinity to recommended range • Run jet pump and clean filter • Drain and refill the spa
Water Odor	<ul style="list-style-type: none"> • Excessive organics in water • Improper sanitization • Low pH 	<ul style="list-style-type: none"> • Shock spa with sanitizer • Add sanitizer • Adjust pH to recommended range
Chlorine Odor	<ul style="list-style-type: none"> • Chloramine level too high • Low pH 	<ul style="list-style-type: none"> • Shock spa with sanitizer • Adjust pH to recommended range
Musty Odor	<ul style="list-style-type: none"> • Bacteria or algae growth 	<ul style="list-style-type: none"> • Shock spa with sanitizer – if problem is visible or persistent, drain, clean and refill the spa
Organic buildup / scum ring around spa	<ul style="list-style-type: none"> • Buildup of oils and dirt 	<ul style="list-style-type: none"> • Wipe off scum with clean rag – if severe, drain the spa, use a spa surface and tile cleaner to remove the scum and refill the spa
Algae Growth	<ul style="list-style-type: none"> • High pH • Low sanitizer level 	<ul style="list-style-type: none"> • Shock spa with sanitizer and adjust pH • Shock spa with sanitizer and maintain sanitizer level
Eye Irritation	<ul style="list-style-type: none"> • Low pH • Low sanitizer level 	<ul style="list-style-type: none"> • Adjust pH • Shock spa with sanitizer and maintain sanitizer level
Skin Irritation / Rash	<ul style="list-style-type: none"> • Unsanitary water • Free chlorine level above 5 ppm 	<ul style="list-style-type: none"> • Shock spa with sanitizer and maintain sanitizer level • Allow free chlorine level to drop below 5 ppm before spa use
Stains	<ul style="list-style-type: none"> • Total alkalinity and/or pH too low • High iron or copper in source water 	<ul style="list-style-type: none"> • Adjust total alkalinity and/or pH • Use a stain and scale inhibitor
Scale	<ul style="list-style-type: none"> • High calcium content in water – total alkalinity and pH too high 	<ul style="list-style-type: none"> • Adjust total alkalinity and pH – if scale requires removal, drain the spa, scrub off the scale, refill the spa and balance the water • Use a stain and scale inhibitor

Cleaning and Maintenance

Removing and Reseating the Pillows

You can remove the pillows for cleaning and maintenance quickly and easily. This method works for all types of pillows.

Grab the lower edge of the pillow with both hands firmly and pull up. As you do this, the pillow inserts will pop out of the holes.

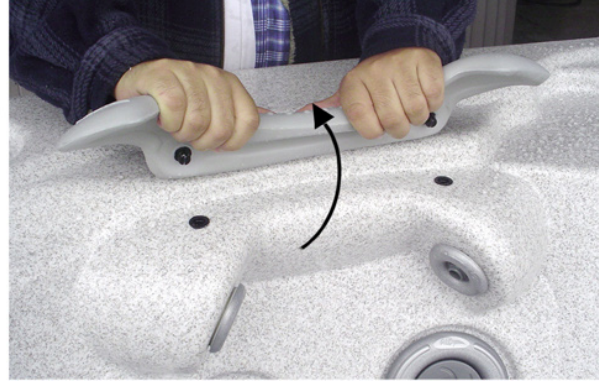

Reseat the pillows by aligning the pillow inserts with the holes and striking the pillow hard enough to insert the pegs back into the holes.



Spa Cover

Important! Keep the spa covered when not in use!

- Covered spas will use less electricity in maintaining your set temperature.
- Covering your spa will protect your spa's finish from the sun's ultraviolet rays.
- You are required to keep the spa covered to maintain warranty coverage.
- Covering your spa helps prevent children from drowning in the spa.

See the manual enclosed with your cover for instructions on mounting the locks and how to lock and unlock the cover.

In addition, while the spa cover is rigid, it is not designed to support any weight. Therefore, as a safety precaution and to preserve the life of your cover, you must not sit, stand, or lie on it, nor should you place objects of any kind on top of it.

Draining Your Portable Spa

Your spa should be drained every four to six months, and refilled with fresh tap water. The following is the recommended method for draining your spa.

1. Turn off the power at the breaker.
2. Remove all filters.

If your drain valve is mounted on the side of the spa cabinet as shown at right, proceed to step 5.

If your drain valve is located inside the spa cabinet:

3. Using a Phillips screwdriver, remove the screws to the access panel and open it.
4. Locate hose ending with the 3/4 inch hose-bib fixture.

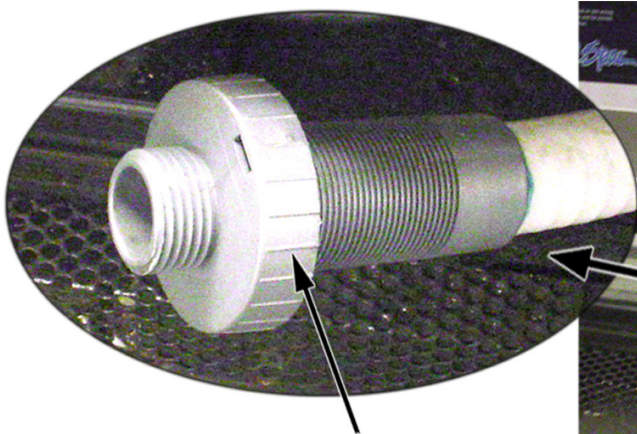

Hose-bib fixture

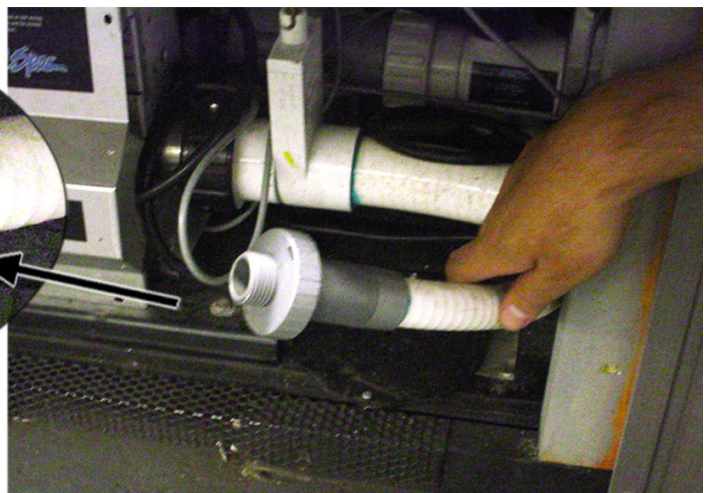

5. Hook up the female end of a garden hose to the drain fitting.
6. Place the other end of the garden hose where you would like the water to drain to.
7. Twist the hose-bib fixture counterclockwise and pull to open the drain.
8. Let spa drain completely, then remove garden hose.
9. Twist the hose-bib fixture clockwise to close it.

Cleaning and Replacing the Filter

Filtration is one of the most important steps you can take to ensure clean, clear water. It is far less expensive to fix water clarity problems by filtering your spa than by using excessive amounts of chemicals, excessive filtration times, or by water replacement.

See the section "Clear Water Plan" for more information on cleaning your filter.

Winterizing (Cold Climate Draining)

In many areas of the country, the temperature drops below 32°F (0°C). We recommend that you always have your spa full of water and running at normal spa temperatures (80°F to 100°F, 26.7°C to 37.8°C). This will help reduce the risk of freezing in your spa and your spa's equipment.

Warning: If you find the need to drain your spa, please be aware of the potential of freezing in your spas equipment and plumbing. Even if the directions below are followed perfectly, there is no guarantee that your spa will not suffer freeze damage.

Freeze damage is not covered by your warranty.

1. Open all filter covers.
2. Remove the filter baskets and filters.
3. Drain your spa completely as described in the instructions above.
4. Vacuum water from the spa's main drain fitting with a wet/dry vacuum.
5. Remove drain plugs from the front of the pumps.
6. Disconnect the unions from both sides of the pump.
7. Blow any remaining water out of the jets and equipment area with the wet/dry vacuum.
8. Cover your spa with a good spa cover and an all-weather tarp to ensure that neither rain nor snow enters the spa.

NOTE: All manifolds are plumbed in series directly to the main drain (see example at right), making it easier to remove water and reducing the possibility of freeze damage.

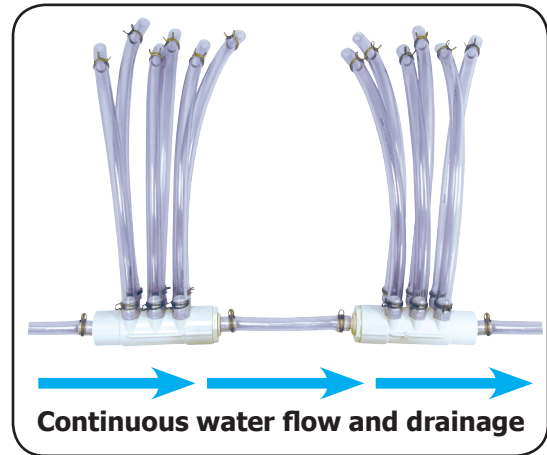

Vacation Care

You can leave your spa unattended for up to two weeks if you follow these instructions.

ALWAYS lock your cover using the cover locks if you plan to be away from home and the spa is filled with water.

1. Set the spa to Sleep Mode. (See instructions on page 12 or page 14 for changing modes.)
2. Following the water quality instructions starting on page 24, adjust the pH.
3. Shock the water (add either chlorine or bromine sanitizer).
4. When you return, check and adjust the pH and shock the water.

If you will not be using your spa for longer than 14 days and a spa maintenance service is not available, we strongly recommend you drain or winterize your spa.

Cleaning Your Spa

Spa Cover and Pillows

Due to the constant punishment your spa cover and pillows receive, you should protect them by applying Cal Spas Vinyl and Leather Cleaner as part of your monthly maintenance plan. It is specifically designed to protect spa covers and pillows from chemical and ultraviolet light damage. It accomplishes this without leaving an oily residue behind that is normally associated with common automotive vinyl protectants.

Warning: Do not use automotive vinyl protectants on spa covers or pillows. These products are generally oil-based and will cause severe water clarity issues that are difficult to correct.

Spa Shell

Each time you drain your spa, before you refill it you should clean your spa shell with our Cal Spas All-Purpose Cleaner and apply a protective coat of Cal Spas Fast Sheen.

Cal Spas All-Purpose Cleaner is a low detergent, non-abrasive cleaner specifically formulated to clean the spa without damaging its acrylic finish.

Cal Spas Fast Sheen is a non-oil based wax that is specifically formulated to protect the spa's finish from the chemicals and minerals associated with normal spa use.

1. Spray Cal Spas™ Multi-Purpose Cleaner directly to the spa's finish.
2. Wipe clean with a soft cloth.
3. Repeat on heavily calcified areas.
4. Wipe spa thoroughly with a wet sponge, rinsing often in a bucket of clean water.
5. Allow the spa to dry completely.
6. Apply a coat of Cal Spas™ Fast Sheen to the spa's entire finish with a soft cloth or sponge.
7. Allow Fast Sheen to dry until white and powdery.
8. Buff clean with a soft cloth, rotating frequently.

IMPORTANT: Do not use any of these products on spas full of water. Only apply to clean, cool, dry surfaces. Incorrect product usage may cause water clarity issues.

Jet Removal and Replacement

Rotate the jet face counterclockwise until you feel some resistance.

Continue to rotate the jet for another quarter turn. You will feel the jet snap out of position. Continue to rotate the jet as you pull it out of the jet well.

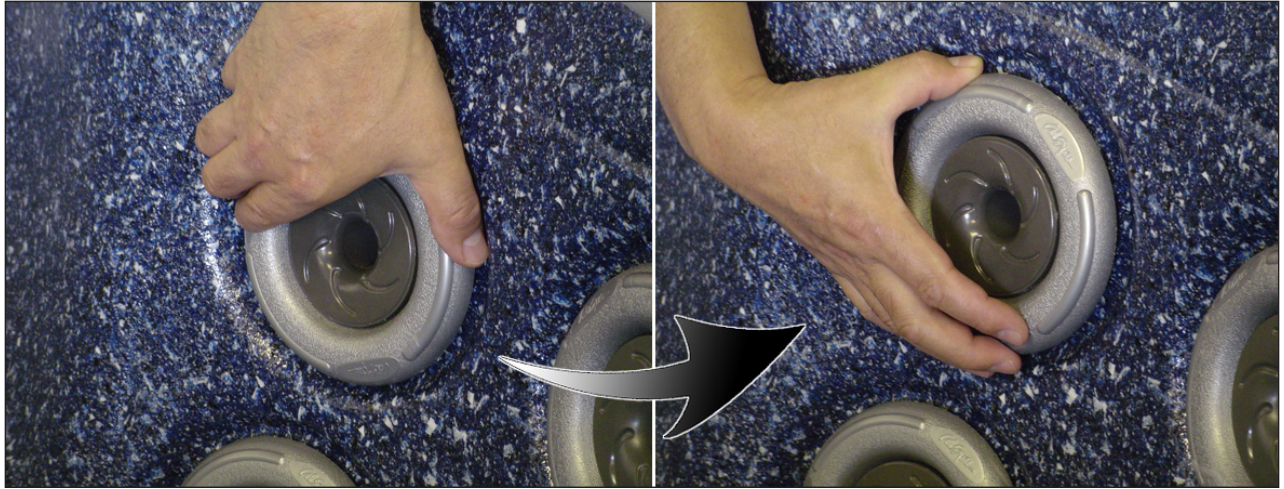

To replace jets, insert the jet in the jet well and push and rotate it clockwise until you feel it snap into position. When the jet face can be rotated freely, it is properly seated.

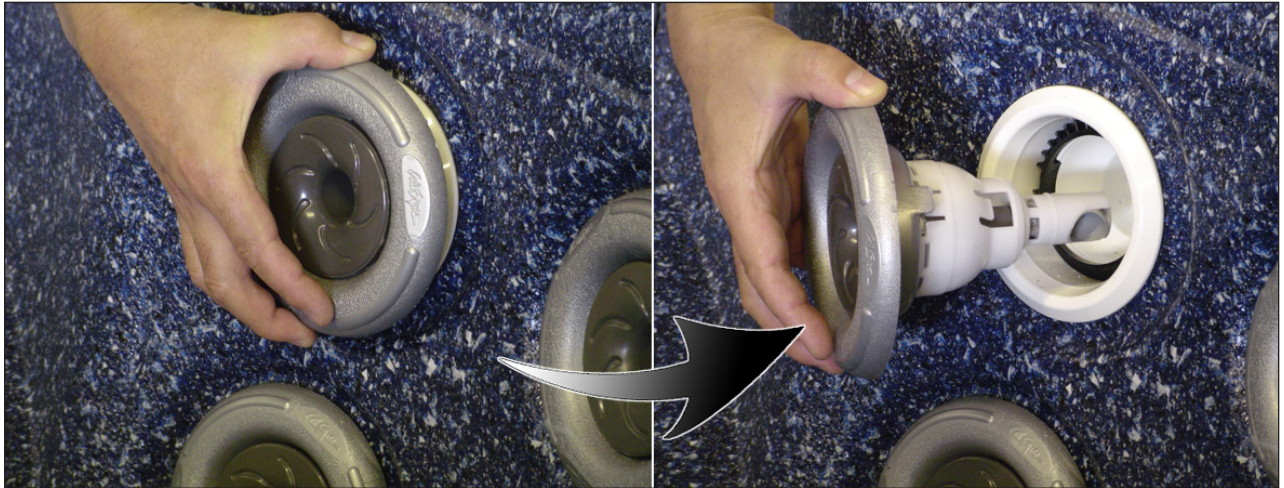

Using the Entertainment System

Some spas may be equipped with audio/visual entertainment options. Several options are available and include marine grade CD players and an iPod docking station. Each spa equipped with an audio/visual system is delivered with the manufacturer's operating instructions in a clear plastic bag.

The instructions contained in this manual describe only basic functions. See the manufacturer's operating instructions for other features and functions. We strongly recommend that you read the manufacturer's instructions prior to operating this unit.

Observe the following precautions for your entertainment system:

- Make sure that hands and CDs are dry before coming in contact with this or any electronic option.
- Always close the CD protective door.
- Do not place wet CD's into this unit at any time.
- Water damage is not covered by Cal Spas or the manufacturer's warranty.

Although the marine grade entertainment system is encased in a plastic housing with weather seals, the system is **water resistant** and **NOT waterproof**. You must take every precaution to keep this system dry! Water damage is not covered by Cal Spas or the manufacturer's warranty.

Listening to the Radio

1. Press the POWER button on the unit or the remote control to turn the system on. The system automatically starts in the mode it was in when it was last shut off.
2. Press the SOURCE or MODE button to switch to the radio mode.
3. Press the left and right arrows located at the far right of the panel to tune the radio to a station.

Playing a CD

You can play CDs with any of the media systems.

1. Insert a disc in the disc drive as described above. The player will identify the type of disc and begin playing it.
2. Use either the remote control or the buttons on the faceplate to start and stop the player and to jump to selections.
3. To remove the disc, press the EJECT button.

Inserting and Ejecting a Disk

For the Sony CDX-HS70MW system:

1. Press the OPEN button on the unit. The faceplate will lower and expose the disk drive.
2. Insert a disk in the disk drive.
3. Flip up the faceplate.

To remove the disc, press the OPEN button. The faceplate will open. Press the small EJECT button located to the left of the disk drive slot.

For the Sony CDX-GT10M system, simply insert a disk into the slot in the faceplate. To remove the disc, press the EJECT button.

Using the iPod Docking Station

To play an iPod from the docking station to the spa's stereo system:

1. Place the iPod in the docking station.
2. Press the SOURCE button on the stereo until the display shows AUX.
3. Play the iPod.
4. Adjust volume using the volume control in the docking station.



Programming the Universal Remote Control

The Cal Spas universal remote has been pre-programmed to function with the entertainment system the spa has been configured with. However, in case you need to reprogram the remote, use the device list below for the programming code.

1. Turn on the device (TV, CD player, DVD player) with the manufacturer's remote control.
2. Press the button on the remote for the device you want to program (TV, CD, DVD, etc.)
3. Press and hold the SETUP button until the LED blinks twice.
4. Enter the device code. If you perform this procedure correctly, the LED will blink twice. If not, repeat steps 2 and 3.

Device Manufacturer	Device Type	Code
Sony CDX-GT10M	CD	1440
Sony CDX-HS70MW	CD	1440
Samsung 42" plasma (Galaxy spa only)	TV	1312

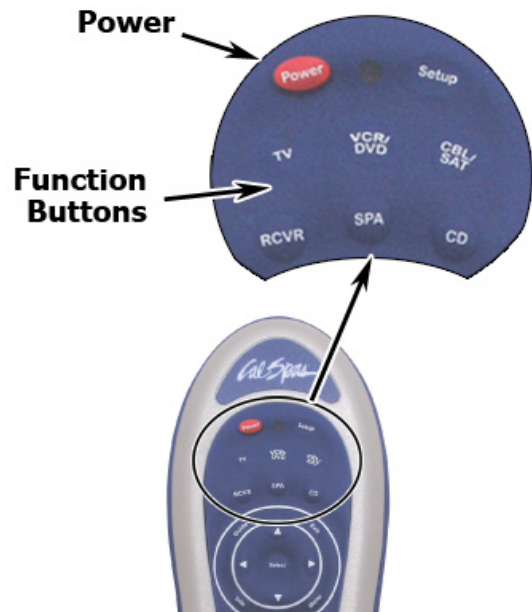

Using the iSound Remote Music System

The iSound Remote Music System comes with the SoundCast iCast transmitter and OutCast wireless speaker. This is a stand-alone audio product manufactured by SoundCast Systems. It is not integrated with any Cal Spa product.

The OutCast system is ideal for use outdoors and especially in an environment with a pool or spa. The portable wireless speaker is extremely water resistant (but not waterproof) and is free from interference from other wireless devices such as cordless or cell phones, microwave ovens, remotes, or wireless routers.

The OutCast system comes with its own owner's manual. It describes parts included, installation, and proper use. Owners of the OutCast system must read this manual.

The iCast Transmitter is tailored to the needs of Apple iPod owner. The iCast transmitter is specially configured to accommodate currently available iPods, using approved interchangeable inserts in the docking bay.

Note: The OutCast system includes an MP3 docking station, transmitter, and remote speaker and does NOT INCLUDE an MP3 player such as an iPod.



About the SunBriteTV Monitor

Because Cal Spas does not offer an integrated TV or DVD option with any line of spas, we recommend spa owners use the SunBriteTV monitor as a high quality, weather resistant video monitor.

The SunBriteTV monitor is a stand-alone video product and is not manufactured by Cal Spas. The SunBriteTV monitor comes with its own owner's manual. Owners of the SunBriteTV must read this manual.

It is designed for permanent outdoor installation and is suitable for use adjacent to your spa.

This television is highly adaptable to most kinds of installation with a wide variety of video input options such as DVD or cable TV and easily customizable according to spa owners' preferences and circumstances.

You will need to coordinate the installation of your video system with your spa dealer.



THE SUNBRITETV MUST BE INSTALLED NO LESS THAN FIVE FEET AWAY FROM ANY BODY OF WATER (SUCH A POOL OR SPA).

Check local building codes and consult your spa dealer for proper installation guidelines.

Appendix





Replacement Parts

Jets	
<p>CRW 5.5" Power Storm</p> <p>Stainless steel: PLU21703677 Cobalt blue: PLU21703677-BLU</p>	
<p>ED 2.25" Euro Directional</p> <p>Stainless steel: PLU21703674 Cobalt blue: PLU21703662-BLU</p>	
<p>ELE 2.25" Euro Less Eyeball</p> <p>Stainless steel: PLU21703663 Cobalt blue: PLU21703663-BLU</p>	
<p>EW 2" Euro</p> <p>Stainless steel: PLU21703621 Cobalt blue: PLU21703621-BLU</p>	
<p>EWD 2" Neck Euro</p> <p>Stainless steel: PLU21703675 Cobalt blue: PLU21703675-BLU</p>	
<p>mfc 3" Micro Flow Directional</p> <p>Stainless steel: PLU21703664 Cobalt blue: PLU21703664-BLU</p>	
<p>MFRW 3.25" Neck Blasters</p> <p>Stainless steel: PLU21703627 Cobalt blue: PLU21703627-BLU</p>	
<p>MFW 4" Maxi Flow</p> <p>Stainless steel: PLU21703630 Cobalt blue: PLU21703630-BLU</p>	
<p>mfw 3" Micro Flow</p> <p>Stainless steel: PLU21703631 Cobalt blue: PLU21703631-BLU</p>	

Jets	
<p>MJW 5.5" Shower Storm</p> <p>Stainless steel: PLU21703625 Cobalt blue: PLU21703625-BLU</p>	
<p>MNW 3" Neck</p> <p>Stainless steel: PLU21703628 Cobalt blue: PLU21703628-BLU</p>	
<p>msw 3" Micro Swirl</p> <p>Stainless steel: PLU21703632 Cobalt blue: PLU21703632-BLU</p>	
<p>OZ 2" Ozone Injector</p> <p>Stainless steel: PLU21700818 Cobalt blue: PLU21700818-BLU</p>	
<p>PSA 5.5" Power Storm Acupressure</p> <p>Stainless steel: PLU21703668 Cobalt blue: PLU21703668-BLU</p>	
<p>PSD 4" Polystorm Directional</p> <p>Stainless steel: PLU21703661 Cobalt blue: PLU21703661-BLU</p>	
<p>PSR 5.25" Power Storm Rifle</p> <p>Stainless steel: PLU21703666 Cobalt blue: PLU21703666-BLU</p>	
<p>PST 5.25" Power Storm Twister</p> <p>Stainless steel: PLU21703665 Cobalt blue: PLU21703665-BLU</p>	





Jets	
<p>SFW 5.5" Sure Flow Stainless steel: PLU21703626 Cobalt blue: PLU21703626-BLU</p>	
<p>SW Swim PLU21700565</p>	
<p>SXW 5.5" Storm, 2 Hole Stainless steel: PLU21703623 Cobalt blue: PLU21703623-BLU</p>	
<p>T 5.25" Tornado Stainless steel: PLU21703629 Cobalt blue: PLU21703629-BLU</p>	
<p>W 4" Whirlpool Stainless steel: PLU21703609 Cobalt blue: PLU21703609-BLU</p>	
<p>Jet Stream Propulsion PLU21702620</p>	





Valves	
<p>1" LED Diverter Valve with Swoosh Logo PLU21300450</p>	
<p>2" LED Diverter Valve with Swoosh Logo PLU21300460</p>	
<p>1" Diverter Valve Silver Handle with Dark Gray Cap and Wall Fitting PLU21300470</p>	
<p>2" Diverter Valve Silver Handle with Dark Gray Cap and Wall fitting PLU21300480</p>	
<p>Air Control with Swoosh Logo PLU21300500</p>	
<p>Air Control Valve Silver Handle with Dark Gray Cap and Wall Fitting PLU21300510</p>	
<p>2" Large Diverter Valve, Silver Cap PLU21300043</p>	
<p>1" Large Diverter Valve, Silver Cap PLU21300047</p>	
<p>1" Air Control, Silver Cap PLU21700378</p>	

Pillows	
Quad ACC01400931	
Neck Blaster ACC01401010	
Cascade (Logo) ACC01401030	
Infinity ACC01400950	
Neck ACC01401040	

Drains	
Main Drain, Super Hi Flo Suction 2 1/2" Silver PLU21400137	
Bottom Drain Star Suction Cover PLU21400197	
Bottom Drain Filtration Return Assembly OZO18300005	

Waterfalls	
Cascade Waterfall PLU21800820	
Filter Waterfall PLU21800830	
Vertical Waterfall PLU21800840	

Filters	
Filter Cartridge, 75 Sq Ft, Anti-Bacterial, with Chemical Chamber FIL11100215	
Filter Cartridge, 50 Sq Ft, Anti-Bacterial, with Chemical Chamber FIL11100205	
Filter Cartridge 75 Sq Ft, Anti-Bacterial FIL11703211	
Filter Cartridge, 50 Sq Ft, Anti-Bacterial FIL11100201	

Lights	
Light Assembly Complete LIT16000150	
Light Mini 2" Diameter LIT16000151	
Walfitting, Clear Lens Cap, Jumbo Spa Light, 5" LIT16100153	
Red Lens Insert, Jumbo Spa Light LIT16100155	
Blue Lens Insert, Jumbo Spa Light LIT16100156	

Ozone Cartridges
Cal Zone Quest 2000 Replacement Cartridge OZO18100020

Pure XL UV Water Sanitizer
Pure XL Water Sanitizer, Complete System XXX12345678
Replacement UV Lamp XXX12345678
Replacement Quartz Sleeve XXX12345678
O-Ring for Twist Top XXX12345678
Quartz Cap, Clear XXX12345678
Rubber Seal, Purple XXX12345678
25 Watt Transformer, 220V XXX12345678

LED Lights	
Small Controller Daisy Chain LIT16100179	
2' Daisy Chain Jumper LIT16100183	
Overmold Adapter for Small Controller LIT16100209	
Quad LED Daisy Chain Assembly LIT16100211	
Dual LED Daisy Chain Assembly LIT16100212	
7 LED 2" Light Daisy Chain with Stand-Off LIT16100214	
Faceted Bullet Lens, Polycarbonate, UV Stable LIT16100215	
Silicone O-Ring for Lens LIT16100208	

Replacement Cabinet Panels

The complete selection of replacement cabinets for all models is very extensive and too lengthy for this owner's manual. See your Cal Spas deal to order replacement panels for your spa, or call 1-800-CAL-SPAS.

Covers

Avalon Series	
A515/A526/A534	
84" X 64"	
Standard Rust	ACC01200460
Standard Gray	ACC01200461
Standard Slate	ACC01200464
Standard Palomino	ACC01200466
Deluxe Rust	ACU02200500
Deluxe Gray	ACU02200501
Deluxe Slate	ACU02200502
Deluxe Palomino	ACU02200499
A726 / A734 / A744	
84" X 84"	
Standard Rust	ACC01200410
Standard Gray	ACC01200411
Standard Slate	ACC01200412
Standard Palomino	ACC01200419
Deluxe Rust	ACU02200250
Deluxe Gray	ACU02200251
Deluxe Slate	ACU02200256
Deluxe Palomino	ACU02200257
A826 / A834 / A844 / A857	
93" X 93"	
Standard Rust	ACC01200420
Standard Gray	ACC01200421
Standard Slate	ACC01200422
Standard Palomino	ACC01200423
Deluxe Rust	ACU02200260
Deluxe Gray	ACU02200261
Deluxe Slate	ACU02200266
Deluxe Palomino	ACU02200267
A969L	
93" X 130"	
Standard Rust	ACC01200450
Standard Gray	ACC01200451
Standard Slate	ACC01200452
Standard Palomino	ACC01200454
Deluxe Rust	ACU02200290
Deluxe Gray	ACU02200291
Deluxe Slate	ACU02200295
Deluxe Palomino	ACU02200289

Classic Series	
CA-36/CBA-36/CD-46/CM-47/ CA-50/CBA-50/CBA-64/CA-65	
93" X 93"	
Standard Rust	ACC01200420
Standard Gray	ACC01200421
Standard Slate	ACC01200422
Standard Palomino	ACC01200423
Deluxe Rust	ACU02200260
Deluxe Gray	ACU02200261
Deluxe Slate	ACU02200266
Deluxe Palomino	ACU02200267
Custom Teal	ACU02200262
Custom Navy	ACU02200263
Custom Hunter	ACU02200264
CD-46	
93" OCTAGON	
Standard Rust	ACC01200434
Standard Gray	ACC01200435
Standard Slate	ACC01200436
Standard Palomino	ACC01200433
Deluxe Rust	ACU02200277
Deluxe Gray	ACU02200278
Deluxe Slate	ACU02200279
Deluxe Palomino	ACU02200276
Custom Teal	ACU02200287
Custom Navy	ACU02200288
Custom Hunter	ACU02200298
CE-56	
96" x 135"	
Standard Rust	ACC01200440
Standard Gray	ACC01200441
Standard Slate	ACC01200444
Standard Palomino	ACC01200445
Deluxe Rust	ACU02200280
Deluxe Gray	ACU02200281
Deluxe Slate	ACU02200285
Deluxe Palomino	ACU02200286
Custom Teal	ACU02200282
Custom Navy	ACU02200283
Custom Hunter	ACU02200284

CN-48/CN-63		93" x 130"	
Standard Rust		ACC01200450	
Standard Gray		ACC01200451	
Standard Slate		ACC01200452	
Standard Palomino		ACC01200454	
Deluxe Rust		ACU02200290	
Deluxe Gray		ACU02200291	
Deluxe Slate		ACU02200295	
Deluxe Palomino		ACU02200289	
Custom Teal		ACU02200296	
Custom Navy		ACU02200297	
Custom Hunter		ACU02200299	
CL-25		64" x 84"	
Standard Rust		ACC01200460	
Standard Gray		ACC01200461	
Standard Slate		ACC01200464	
Standard Palomino		ACC01200466	
Deluxe Rust		ACU02200500	
Deluxe Gray		ACU02200501	
Deluxe Slate		ACU02200502	
Deluxe Palomino		ACU02200499	
Custom Teal		ACU02200503	
Custom Navy		ACU02200504	
Custom Hunter		ACU02200505	
CP-34/CT-34/CP-48/ CT-48/CP-63/CT-63		84" x 84"	
Standard Rust		ACC01200410	
Standard Gray		ACC01200411	
Standard Slate		ACC01200412	
Standard Palomino		ACC01200419	
Deluxe Rust		ACU02200250	
Deluxe Gray		ACU02200251	
Deluxe Slate		ACU02200256	
Deluxe Palomino		ACU02200257	
Custom Teal		ACU02200252	
Custom Navy		ACU02200253	
Custom Hunter		ACU02200254	

CV-34		84" X 93"	
Standard Rust		ACC01200462	
Standard Gray		ACC01200463	
Standard Slate		ACC01200465	
Standard Palomino		ACC01200467	
Deluxe Rust		ACU02200510	
Deluxe Gray		ACU02200511	
Deluxe Slate		ACU02200512	
Deluxe Palomino		ACU02200509	
Custom Teal		ACU02200513	
Custom Navy		ACU02200514	
Custom Hunter		ACU02200515	

Fitness Series			
F2400		96" x 169"	
Deluxe Rust		ACU02200420	
Deluxe Gray		ACU02200421	
Deluxe Slate		ACU02200422	
Deluxe Palomino		ACU02200423	
Custom Teal		ACU02200424	
Custom Navy		ACU02200425	
Custom Hunter		ACU02200426	
F2500		93" x 206"	
Deluxe Rust		ACU02200400	
Deluxe Gray		ACU02200401	
Deluxe Slate		ACU02200402	
Deluxe Palomino		ACU02200406	
Custom Teal		ACU02200403	
Custom Navy		ACU02200404	
Custom Hunter		ACU02200405	
F4700		96" x 202"	
Deluxe Rust		ACU02200407	
Deluxe Gray		ACU02200408	
Deluxe Slate		ACU02200409	
Deluxe Palomino		ACU02200410	
Custom Teal		ACU02200411	
Custom Navy		ACU02200412	
Custom Hunter		ACU02200413	

Family II Series	
FII515B 78" ROUND	
Standard Rust	
Standard Gray	
Standard Slate	
Standard Palomino	
Deluxe Rust	
Deluxe Gray	
Deluxe Slate	
Deluxe Palomino	
Deluxe Teal	
Deluxe Navy	
Deluxe Hunter	
FII518B 43" x 83"	
Standard Rust	
Standard Gray	
Standard Slate	
Standard Palomino	
Deluxe Rust	
Deluxe Gray	
Deluxe Slate	
Deluxe Palomino	
Deluxe Teal	
Deluxe Navy	
Deluxe Hunter	
FII520B 54" x 78"	
Deluxe Rust	ACC01200370
Standard Gray	ACC01200371
Standard Slate	ACC01200373
Standard Palomino	ACC01200374
Deluxe Rust	ACU02200210
Deluxe Gray	ACU02200211
Deluxe Slate	ACU02200216
Deluxe Palomino	ACU02200217
Deluxe Teal	ACU02200212
Deluxe Navy	ACU02200213
Deluxe Hunter	ACU02200214

FII730/FII745 84" x 84"	
Standard Rust	ACC01200410
Standard Gray	ACC01200411
Standard Slate	ACC01200412
Standard Palomino	ACC01200419
Deluxe Rust	ACU02200250
Deluxe Gray	ACU02200251
Deluxe Slate	ACU02200256
Deluxe Palomino	ACU02200257
Deluxe Teal	ACU02200252
Deluxe Navy	ACU02200253
Deluxe Hunter	ACU02200254
FII830/FII845 93" x 93"	
Standard Rust	ACC01200420
Standard Gray	ACC01200421
Standard Slate	ACC01200422
Standard Palomino	ACC01200423
Deluxe Rust	ACU02200260
Deluxe Gray	ACU02200261
Deluxe Slate	ACU02200266
Deluxe Palomino	ACU02200267
Deluxe Teal	ACU02200262
Deluxe Navy	ACU02200263
Deluxe Hunter	ACU02200264
Galaxy Series	
GX49 93" x 93"	
Deluxe Rust	ACU02200260
Deluxe Gray	ACU02200261
Deluxe Slate	ACU02200266
Deluxe Palomino	ACU02200267

Victory Xtreme Series	
VX901 72" x 72"	
Standard Rust	ACC01200566
Standard Gray	ACC01200567
Standard Slate	ACC01200568
Standard Palomino	ACC01200559
FX624B 76" x 84"	
Standard Rust	ACC01200406
Standard Gray	ACC01200407
Standard Slate	ACC01200508
Standard Palomino	ACC01200509
Deluxe Rust	ACU02200362
Deluxe Gray	ACU02200363
Deluxe Slate	ACU02200367
Deluxe Palomino	ACU02200358
Custom Teal	ACU02200372
Custom Navy	ACU02200373
Custom Hunter	ACU02200374
VX724L 78" x 84"	
Standard Rust	ACC01200520
Standard Gray	ACC01200521
Standard Slate	ACC01200522
Standard Palomino	ACC01200523
VX726B/L, VX740L 84" x 84"	
Standard Rust	ACC01200410
Standard Gray	ACC01200411
Standard Slate	ACC01200412
Standard Palomino	ACC01200419
Deluxe Rust	ACU02200250
Deluxe Gray	ACU02200251
Deluxe Slate	ACU02200256
Deluxe Palomino	ACU02200257
Custom Teal	ACU02200252
Custom Navy	ACU02200253
Custom Hunter	ACU02200254

VX834B/L, VX848B/L, VX860B/L 93" x 93"	
Standard Rust	ACC01200420
Standard Gray	ACC01200421
Standard Slate	ACC01200422
Standard Palomino	ACC01200423
Deluxe Rust	ACU02200260
Deluxe Gray	ACU02200261
Deluxe Slate	ACU02200266
Deluxe Palomino	ACU02200267
Custom Teal	ACU02200262
Custom Navy	ACU02200263
Custom Hunter	ACU02200264

Keeping Fit with your Spa

IMPORTANT: Always consult your physician before starting any exercise activity or program. The Ultimate Fitness series spas feature rubber exercise bands. When stretched, these bands create a high tension condition. Improper use or failure to connect the exercise bands properly may cause injury. Always inspect all of the exercise equipment prior to beginning any exercise. Do not use any damaged equipment

The fitness equipment consists of: two rowing arm bars, two 62" exercise bands, two 32" exercise bands, two 27" exercise bands, two hand grips, two ankle bands, two hand loops, and an exercise belt. This equipment attaches to the exercise anchors located on the spa walls.

Ultimate Fitness Series Exercise Program

Refer to the equipment configurations shown on the next page for the following exercises.

Seated Row

Use the exercise bars in a seated position with your feet stable, abs tight and lower back stable. Keep your palms down, arms extended with elbows slightly bent. Pull towards your chest squeezing your shoulder blades to the middle back and returning slowly to the starting position.

Standing Chest Fly

Using the exercise grips, place palms sideways facing your body with your elbows slightly bent. Pull your body forward, bringing hands together, squeezing and flexing chest muscles, then slowly returning to the starting position.

Standing Chest Press

Using the exercise grips, place your palms down with your elbows bent at 90°. Press forward bringing your hands together, squeezing and flexing your chest muscles, then slowly return to the start position.

Standing Shoulder Press

Using the exercise grips, place your palms facing away from your body with your elbows bent at 90°. Press upward bringing your hands together in front of you, above your head and slowly return to the start position.

Arm Curls

Using the exercise grips, place your hands face up with your elbows slightly bent, pull upward towards your chin squeezing and flexing your biceps then slowly return to start position.

Running or Walking

Attach the exercise belt around your waist and attach the two 62" exercise bands to the far wall of the spa. Turn on the two swim jets and walk or run into jet stream.

Leg Stretching and Strength Training

Attach an ankle band to your ankle and attach a 62" exercise band to any exercise anchor. Lift your leg to the side or back as the band provides tension.

Connecting the Exercise Equipment

The drawings below show different ways the exercise kit can be connected depending on the exercises you wish to do.

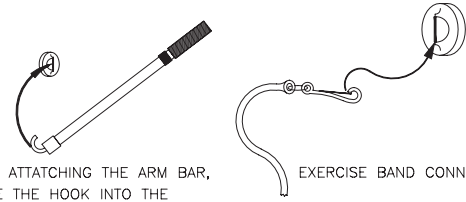

WHEN ATTACHING THE ARM BAR, PLACE THE HOOK INTO THE EYE PAD AS SHOWN.

EXERCISE BAND CONNECTION

ROWING CONFIGURATION

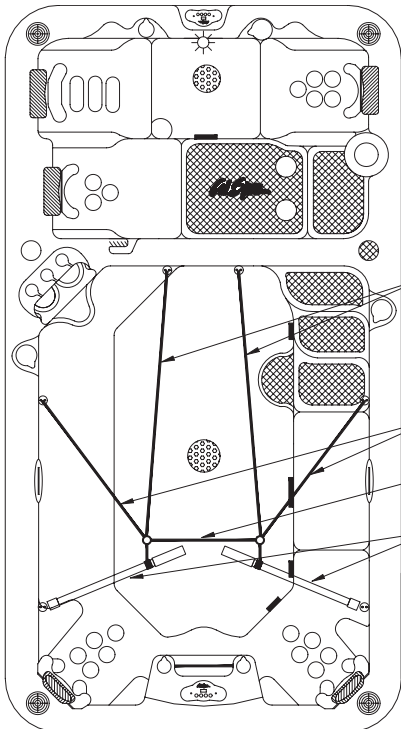

- 62" EXERCISE BANDS
- 32" EXERCISE BANDS
- 27" EXERCISE BAND (OPTIONAL)
- ROWING BARS

STRENGTH TRAINING CONFIGURATION

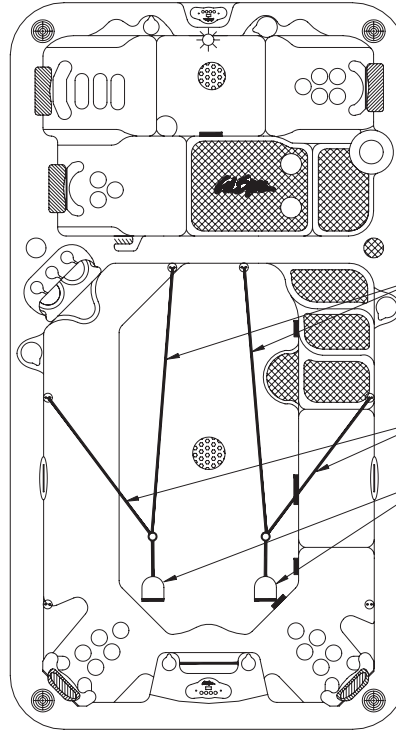

- 62" EXERCISE BANDS
- 32" EXERCISE BANDS (OPTIONAL)
- HAND GRIPS

RUNNING OR WALKING CONFIGURATION

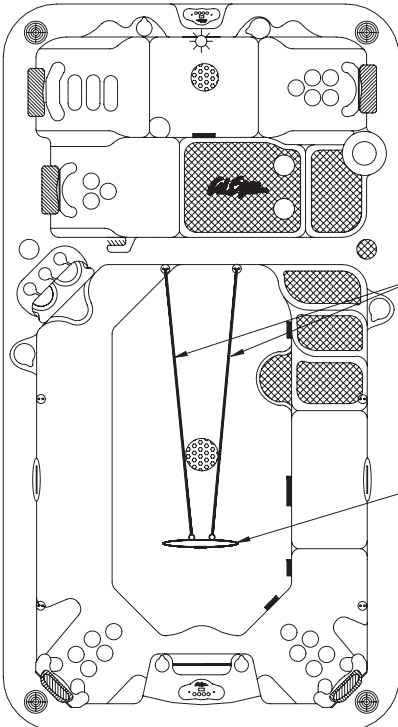

- 62" EXERCISE BANDS
- EXERCISE BELT

STRETCHING CONFIGURATION

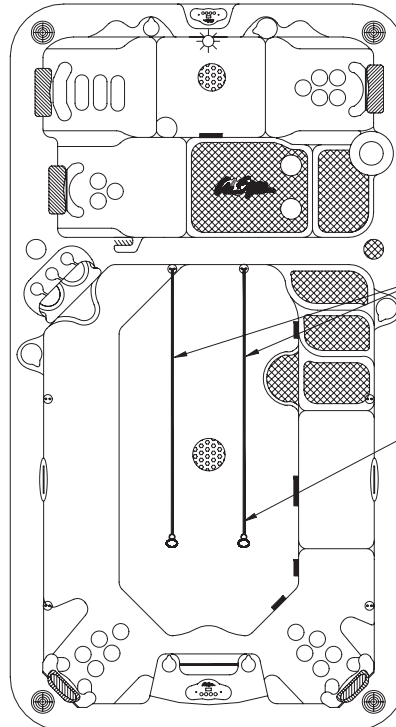

- 62" EXERCISE BANDS
- ANKLE BANDS

Troubleshooting

Symptom	Possible Causes	Possible Solutions
System / Power Problems		
System does not work	Power is turned off	Reset spa
Control pad and spa equipment do not operate	No electrical power to spa	Turn on or reset the GFCI circuit breaker. If this does not solve the problem, have a qualified electrician check the electrical service.
	The 20 or 30A fuse, depending on the system, has blown	Contact your dealer
The spa does not turn off	Spa is trying to heat up	Check the temperature setting is in Standard mode
	Spa is in filter cycle	Normal. No adjustment necessary
	Spa is in Standard mode	Check setting
Control panel displays a message	An error may have occurred	See Diagnostic Messages on page 18 for message code meanings
GFCI breaker trips repeatedly	Improper wiring to spa or GFCI breaker is defective	Consult with a qualified electrician
	There is a defective component on the spa	Contact your dealer
Heat Problems		
Spa does not heat	Heating mode not selected	See control panel instructions on pages 12 through 16
	Water level is too low	Add water to correct level
	No electrical power to spa	Turn on or reset the GFCI circuit breaker. If this does not solve the problem, have a qualified electrician check the electrical service.
	Heater is defective	Contact your dealer
	Gate valve is partially or fully closed	Open gate valves. Note: Never operate your spa with the gate valves closed!
Spa gets warm but does not get hot	Thermostat has been turned down	Set control panel to a higher temperature
	Insufficient filtration time	Increase filtration time
	Water level is too low	Add water to correct level
	No electrical power to spa	Turn on or reset the GFCI circuit breaker. If this does not solve the problem, have a qualified electrician check the electrical service.
	Dirty filter cartridge	Clean filter cartridge
	Gate valves closed	Open gate valves
	Spa cover improperly positioned	Align spa cover
Spa gets too hot	Filtration time is set too long	Reduce filtration cycles, especially during summer months

Symptom	Possible Causes	Possible Solutions
Water Problems		
Water is not clean	For all water clarity problems, see page 24.	
High water consumption	Very high evaporation or heavy splashing	Use the cover and refill as necessary
Low water stream from the jets	Running in FILTER mode - slow speed	Select high speed jets
	Block wall suction or skimmer	Clean the wall suction/skimmer. Remove blockage
	Dirty filter	Clean filter and replace
	Jets are closed	Open jets
	Valves closed	Open valves
No water stream from the jets	Pump has airlock	Remove airlock by priming spa (page 11)
	Jets are closed	Open jets
	Power switched off, system off	Reset power
	Pump is defective	Contact your dealer
	Pump fluctuations	Low water. Check level on skimmer flap
Water leakage from below the spa	Check the connections and empty the hoses	Close or turn off empty cycle if necessary
Water Pressure Problems		
Jets surge on and off	Water level is too low	Add water to normal level
Jets are weaker than normal or do not work at all	Jet valves are partially or fully closed	Open jet valves
	Filter cartridge is dirty	See Cleaning the Filter
	Air is trapped in the pump	Open the air bleed valve on each pump's housing and allow air to bleed out of the system. Be sure to tighten each air bleed valve as soon as water starts to flow.
	The suction fittings are blocked	Remove any debris that may be blocking the suction fittings
	Gate valve is closed	Open gate valves. Note: Never operate your spa with the gate valves closed!
Air and Jets Problems		
No airstream from the jets	Air control not open	Open the control
	Jet spout opening not fixed properly	Check jet spout openings
	Jet spout opening missing	Check jets and replace as necessary
Light Problems		
Standard spa light does not work	Light bulb has burned out	Replace light bulb
	Lighting system is defective	Contact your dealer

Symptom	Possible Causes	Possible Solutions
Pump Problems		
Pump runs constantly – will not shut off	Problem with circuit board	Contact your dealer
Noisy pump	Water level is too low	Add water to normal level
	Block wall suction or skimmer	Clean the wall suction/skimmer
	Damaged or worn-out motor block	Contact your dealer
	Clogged floor suction or skimmer	Clean floor suction or skimmer
	Leakage of air into suction line	Contact your dealer
	Debris is inside pump	Contact your dealer
	Gate valves are closed	Open gate valves. Note: Never operate your spa with the gate valves closed!
	Damaged or worn motor bearings	Contact your dealer
	Improper or defective wiring	Contact your dealer
Pump turns off during operation	Automatic timer has completed its cycle	Start the cycle again
	Pump has overheated due to the vents on the equipment door being blocked	Clear items away from vents
	The pump motor is defective	Contact your dealer
Pump has a burning smell while running	Damaged or worn motor bearings	Contact your dealer
Pump does not work	Power may be turned off	Reset power
	Pump has over heated	Let cool for one hour
	Incorrect or faulty wiring of electrical supply	Contact your dealer
	Switch is off	Auto reset after the motor has cooled down
	House circuit breaker tripped or in OFF position	Reset circuit breaker Contact your dealer
	Motor overload condition	Motor overload will reset automatically. If problem persists, contact your dealer
	Damaged electrical cord	Contact your dealer
	Pump cord not plugged in	Plug pump cord into red receptacle
	GFCI tripped or in OFF position	Reset GFCI

Cal Spas™ Chemicals



Bromine/Chlorine Starter Kit

#CHE07000290/#CHE07000295

When used as directed, this product is effective as a spa and hot tub sanitizer/disinfectant. Treats 250 gallons for up to three weeks.



Vinyl & Leather Cleaner

#CHE07000620

Specifically designed to protect spa covers and pillows from chemical and ultraviolet damage.



Fast Sheen

#CHE07000610

Unique water-based, chemically reactive silicone sealant and polish. Seals, shines, and protects spa surfaces.



Brominating Tablets

#CHE07000760/#CHE07000770

Sanitizer, disinfectant for spas and hot tubs.



Chlorinating Granules

#CHE07000865/#CHE07000880

When used as directed, this product is effective as a spa and hot tub water disinfecting agent.



Go Brom

#CHE07000830

Establishes a bromide bank in spas and hot tubs.



Filter Cartridge Cleaner

#CHE07000690

Breaks down organic and inorganic material. Removes calcium scale and mineral deposits.



Liquid Hardness Increaser

#CHE07000250

Increases water hardness to reduce corrosion. Helps reduce foaming.



Spa Brite

#CHE07000580/#CHE07000590

Clears up cloudy water in spas and hot tubs. Effective at all spa and hot tub temperatures.



Foam Gone

#CHE07000800/#CHE07000810

Breaks up existing foam in spa water. Effective at all spa and hot tub temperatures.



pH-Alkalinity Up

#CHE07000720/#CHE07000730

Helps maintain pH in spas and hot tubs.



pH-Alkalinity Down

#CHE07000750

Lowers pH in spas and hot tubs.



Enzyme Formula

#CHE07000600/#CHE07000605

Emulsifies and biodegrades bodily oils, suntan lotion, and other contaminants in spas and hot tubs.



Metal Protector

#CHE07000630/#CHE07000640

Controls water discoloration caused by minerals. Special Extra Strength formula for spas and hot tubs.



Stain & Scale Prevention

#CHE07000650/#CHE07000660

Prevents minerals from damaging spa components and affecting performance.



Oxidizer Shock

#CHE07000680/#CHE07000710

Destroys organic contaminants and odor-causing wastes.

2010 WARRANTY

**U.S. and Canada
Portable Spas**

This limited warranty is effective for portable spas manufactured after November 23, 2009.

Cal Spas portable spas are warranted to be free from defects in material and workmanship. This warranty starts **from date of manufacture** and ends either by specified time-frame listed below, owner-transfer, relocation, or installation of any component other than by manufacturer.

This limited warranty is only valid on portable spas delivered in the United States and Canada. However, it does not apply to special offers and events and extends through the selling dealer to the original purchaser at the original site of installation. This warranty excludes Designer Series in-ground spas.

	Promo and Premium spas	Platinum spas	Family series, Escape and Victory Xtreme spas	Avalon, Classic, Fitness and Galaxy spas
Spa Shell / Structural				
LMS warrants against the loss of water through the spa shell due to defects in materials and/or workmanship.	2 Years	3 Years	3 Years	5 Years
Interior Surface – Altair Plus / Quarite Plus				
LMS warrants against cracks, blisters, peeling, discoloration and delamination of Altair Plus / Quarite Plus interior surfaces.	2 Years	3 Years	3 Years	5 Years
Interior Surface – Standard Acrylic / Quarite				
LMS warrants against cracks, blisters, peeling, discoloration and delamination of standard acrylic/quarite interior surfaces.	2 Years	3 Years	3 Years	5 Years
Equipment				
LMS warrants the spa's electrical and electronic components, specifically: the control system, pumps and air blowers against malfunction due to defects in materials and/or workmanship.	2 Years	3 Years	3 Years	5 Years
Plumbing				
LMS warrants all factory installed plumbing and Eliminator™ Plus Wet Ends from loss of water due to defects in material and/or workmanship.	2 Years	3 Years	3 Years	5 Years
Cabinets				
LMS warrants Cal Premium™, Cal Select™ and Cal Stone™ panels against cracking and warping. Cabinet surface peeling, blistering, fading, or delamination are specifically excluded from this warranty.	2 Years	3 Years	3 Years	5 Years
Components				
LMS warrants manufacturer-installed XL Heat Exchanger™ and Cal Zone Quest 2000 Ozonator™ against malfunction due to defects in materials and/or workmanship. Specifically excludes replacement ozone cartridge, which has a one year warranty. Also excludes Pure XL UV water sanitizer, which has a one year warranty.	2 Years	3 Years	5 Years	5 Years

Electrical and Electronic Components

LMS warrants stereos, TVs and the LED light source one year.

Manufacturer Warranty

Cal Spas electronic component warranty is extended through the manufacturer of the product including, but not limited to: televisions, stereos, UV water sanitizer components, etc. Spa covers are warranted for one year by manufacturer (except for Promo, Premium, and Platinum spa covers, which are warranted for 90 days) unless otherwise specified.

Warranty Performance

In the event of a malfunction or defect covered under the terms of this warranty, the factory authorized selling dealer is responsible for performing all necessary repairs. To obtain service, contact the selling dealer. In the event the consumer is unable to obtain satisfactory customer service from the selling dealer, written notification must be given to the LMS Customer Relations Department within 30 days of the reported failure. In the event of any warranty replacement, all labor costs (not limited to removal, replacement, and installation) and shipping costs are the responsibility of the spa owner. There will be no charge for parts on a covered item. However, the LMS Service Agent may assess a reasonable travel or mileage charge per service call, which may include diagnostic time. If LMS determines that repair of a covered item is not feasible, LMS reserves the right to replace the defective merchandise with merchandise equivalent or equal in value to the original merchandise. In the event of any warranty replacement, all removal, replacement, installation and shipping costs are the responsibility of the spa owner.

Proration of Warranty

Units determined by the Company to be non-repairable will be replaced on a prorated basis with the same or a comparable unit. The user will be charged one percent of the current retail cost for each full month of ownership from the date of purchase through the date failure is determined to be non-repairable. This charge will be waived during the first twelve months of ownership.

Warranty Limitations and Exclusions

This warranty is void if the spa has been subject to negligence, alteration, misuse, abuse, repairs by non-LMS authorized personnel, incorrect electrical installation, installation by unqualified personnel, installation without a permit if required by local codes, installation of any component other than by the manufacturer, acts of God (including, but not limited to, acts of nature and surrounding environments), and any other cases beyond the control of LMS.

Examples of common acts invalidating this warranty include, but are not limited to:

- Use of spa in a non-residential application.
- Scratches caused by normal use.
- Operation of spas water temperature out of the normal operating range of 32°F (0°C) to 118°F (47.8°C).
- Damage caused by incorrect water level (low, overflow, etc.).
- Damage caused by extreme weather conditions (hot, cold, etc.).

- Damage caused by dirt, sand and calcium.
- Damage caused by clogged filter cartridges. See filter cleaning recommendations in this owner's manual.
- Damage caused by continued operation of this spa with either a known or an unknown problem.
- Damage caused by tri-chlor, acids, chlorine tablets, any floating chemical devices, or any spa chemicals not authorized by LMS.
- Damage caused by improper water chemistry. (High levels of chlorine, bromine, calcium, pH and other excessive chemical levels.)
- Damage caused by direct sunlight. Spas should always be covered when not in use.
- Damage caused as a result of failure to follow operating instructions as defined within this owner's manual.
- Damage caused by incorrect electrical installation, electrical brownout, voltage spikes, or operation of spa out of voltage range by more than ±10%.
- Spas improperly installed or placed on non-approved surfaces.

Although shell cracks, which are breaks in the shell that go all the way through, are covered by this limited warranty, cosmetic scratches, gouges and crazing are not considered cracks and are not covered.

The limited warranty applies only to spas normally used for personal, family or household purposes.

For relocating your spa without voiding your warranty, contact Customer Service for relocation procedures.

Replaceable service items such as filters, light bulbs, pillows, jet inserts, and filter covers are specifically excluded from the limited warranty.

Spa covers and stereo systems are delivered with their own manufacturer's warranty. For more information, please see their warranties in the owner's information package that was delivered with your spa for more information.

Equipment adjustments (such as pressure switch adjustments) are specifically excluded from this warranty.

Disclaimers

This limited warranty is made with the express understanding that the spa is not an essential device or medical device as defined under State and Federal Law. LMS shall not be liable for loss of use of the spa or other incidental or consequential costs, expense or damages, which may include but are not limited to removal of permanent deck or other custom fixtures or the necessity for crane removal. Any implied warranty shall have duration equal of the applicable warranty stated above. Under no circumstances shall LMS or any of its representatives be held liable for injury to any person or damage to any property, however arising.

Legal Remedies

This limited warranty gives you specific legal rights and you may have other rights, which may vary from state to state.

Customer Service

See your Cal Spas dealer for a copy of the applicable warranty, details, and any questions you may have regarding the warranty coverage on your spa.

Warranty Registration

Easy Online Registration

Registering your new Cal Spas product is quick and easy! It is important that you register your Cal Spas product as soon as possible. By taking just a few quick minutes to register, you can enjoy:

- **Product alerts**
- **More efficient support**
- **Quicker service**

Register now -- it's fast and it's easy!

- 1) Go to www.calspas.com/warranty
- 2) Fill in your information and click "Send Warranty Info"

Locating the product serial number

The serial number of your spa is located on a metal plate attached to the lower right front panel of the spa. You will need this number to properly register your spa and activate coverage. Write this information in the space provided below.

Spa Model: _____

Spa Serial Number: _____

Date Purchased: _____

Date Installed: _____

Dealer's Phone Number: _____

Dealer's Address: _____

