

# CalSpa<sup>®</sup>

A Division of California Acrylic Industries, Inc.

CHANGING THE WAY YOU FEEL<sup>®</sup>

Powered by GE Motors

## OWNER'S MANUAL

USA and Canada

### 2000

Pneumatic Series

2100 Electronic Series

2200 Electronic Series

2300 Electronic Series

Duplication without written consent is strictly prohibited.

This Owners Manual is for spas manufactured after January 3, 2000

California Acrylic Industries, Inc. • 1462 East Ninth Street, Pomona CA 91766 • (909) 623-8781

[www.calspas.com](http://www.calspas.com)

Revised December 22, 1999



# Welcome

## To the Cal Spas Family

Congratulations on the purchase of your new Cal Spa. Welcome to our family. You can feel confident knowing that you have purchased the most technologically advanced spa in the industry. Your new spa is backed by the worldwide recognized name in value, reliability, and customer service, Cal Spas.

### **Customer Information:**

We want to learn more about you. After reading this manual, please complete and submit the following Customer Survey and Warranty Registration Card. Your feedback will be used to help us better serve you, our valued customer, and register your spa for its warranty.

### **Cal Spas Information:**

Cal Spas has been manufacturing spas since 1979 and is considered a pioneer and innovator in the industry.

Through our State of the Art manufacturing facility in Pomona California, we manufacture not only the best quality spas, but also an entire line of home resort products. Those products include but are not limited to gazebos, redwood decking and surround packages, billiard tables and billiard accessories, saunas, jetted bathtubs, and much more. Cal Spas is devoted to bringing you a total environment of peace, tranquility, and pure enjoyment with our extensive line of home resort products.

Our exclusive product line features GE Motors, XL Heater, Cal Zone Quest 2000 Ozonator, Spa Cal Filtration, and our Safety Suction System. These features not only set Cal Spas apart from the competition, they also ensure that our customers receive incredible value, performance, and a lifetime of enjoyment. In addition, all of our spas have earned the Underwriters Laboratories® seal of approval. You can rest assured you have invested in a product that is safe and made of the highest quality.

For the aforementioned reasons we can proudly say, Cal Spas, "It's the Logical Choice".



## Table of Contents

Safety Instructions.....	2
Basic Spa Information.....	3
Quick Reference Information.....	4
Set-Up and Delivery Instructions.....	6
110 Volt Information.....	7
220 Volt Information.....	8
Starting Up Your Portable Spa.....	10
Starting Up Your Inground Spa.....	11
Chemical Maintenance .....	12
Filter Maintenance Portable Spas.....	13
Filter Maintenance Inground Spas.....	14
General Operation Instructions.....	15
Pneumatic Operation.....	17
2100 Electronic Operation.....	19
2200 Electronic Operation.....	23
2300 Electronic Operation.....	27
Winterizing and Draining Your Cal Spa.....	31

# IMPORTANT SAFETY INSTRUCTIONS

When installing and using this electrical equipment, basic safety precautions should always be followed, including the following:

1. Read the entire owner's manual and follow instructions before operating the spa
2. Warning-To reduce the risk of injury, do not permit children to use this product unless they are supervised at all times.
3. All 110 volt spas require a DEDICATED 20 AMP SERVICE. Do not use extension cords. Note: This may require a licensed electrician to upgrade your standard receptacle and /or circuit breaker.
4. All 220 volt spas require a DEDICATED 50 AMP GFCI SERVICE WITH FOUR # 6 AWG COPPER WIRES.
5. Danger-Risk of Accidental Drowning. Extreme caution must be exercised to prevent unauthorized access by children. To avoid accidents, ensure that children cannot use the spa unless they are closely supervised at all times (Keep spa cover on when not in use).
6. Danger-Risk of injury. The suction fittings in this spa are sized to match the specific water flow created by the pump. Should the need arise to replace the suction fittings or the pump, be sure that the flow rates are compatible.
7. Never operate spa if the suction fittings or filter baskets are broken or missing.
8. Never replace suction fitting with one rated less than the flow rate marked on the original suction fitting.
9. Danger-Risk of Electric Shock. Install at least 5 feet (1.5m) from all metal surfaces. As an alternative, a spa may be installed within 5 feet of metal surfaces if each metal surface is permanently bonded by a minimum No. 8 AWG solid copper conductor to the outside of the spas control box.
10. Danger-Risk of Electric Shock. Do not permit any electrical appliance, such as a light, telephone, radio, and televisions, within 5 feet (1.5m) of spa. Never attempt to operate any electrical device from inside the spa.
11. Warning-To reduce the risk of injury:
  - a.) Before entering a spa, the user should measure the water temperature with an accurate thermometer, since the tolerance of water temperature-regulating devices varies.
  - b.) The spa water should never exceed 104°F (40°C). Water temperatures between 100° (38°C) and 104°F (40°C) are considered safe for a healthy adult. Lower water temperatures are recommend for young children, and when spa use exceeds 10 minutes.
  - c.) Since excessive water temperatures have a high potential for causing fetal damage during early months of pregnancy, pregnant or possibly pregnant women should always check with a physician prior to spa usage.
  - d.) The use of alcohol, drugs, or medication before or during spa use may lead to unconsciousness with the possibility of drowning.
  - e.) Persons suffering from obesity or with a medical history of heart disease, low or high blood pressure, circulatory system problems or diabetes should consult a physician prior to spa usage.
  - f.) Persons using medication should consult a physician before using a spa since some medication may induce drowsiness while other medication may affect heart rate, blood pressure, and circulation.

Save These Instructions

# Basic Spa Information

Congratulations on the purchase of your new Cal Spa. Our purpose is to provide you with the most relaxing hot water massage you have ever encountered. In order to maximize the pleasure of your new spa, you will need to understand how it works.

Your new Cal Spa has been engineered with a high-powered water pump that pushes water through various therapy jets, which will relax even the tightest of muscles. In addition to the water pressure, you can add air into the spa water with air venturies or the optional turbo feature, to increase the intensity of your massage.

1. Do not be afraid to push buttons or turn knobs to learn about your new Cal Spa, as it is built with quality materials and excellent craftsmanship.
2. The following operating and maintenance instructions are very important, and must be followed carefully. With the proper care and maintenance, your Cal Spa will provide you with years of satisfaction and performance with minimum effort.
3. The filtering of your spa is very important, this alone will cut down cleaning time and use of excess chemicals. We recommend that your spa filters no less than four hours twice a day.
4. Electronically controlled spas will automatically do this when you turn them on for the first time.
5. It is very important to keep the spa covered when not in use for two reasons. The first is heating efficiency; covered spas use less electricity in maintaining your set temperature. The second is to protect your spas finish from the suns ultra violet rays. Covering your spa is mandatory to maintain warranty coverage.
6. Your spas optional turbo feature should be used sparingly. When operating the turbo, water temperature drops quite rapidly and dissipates chemicals.
7. The filter needs to be cleaned on a regular basis. This is very simple and only takes a few minutes. The result is increased water clarity and equipment longevity.  
See pages 13 and 14 for filter cleaning instructions
8. The spas water level is very important to the operation of your spa. If the water level is too low or too high, your spa won't run or clean properly. (The water level should be to the middle of the Skimmer area when no one is in the water.)
9. We recommend that your spa water be changed every 4 to 6 months. You may find the need to change your spa water more often with heavy use.
10. When empty, your spa should be cleaned with a non-abrasive cleaner, like "Cal Spas All Surface Cleaner," then rinsed thoroughly.
11. When filling your spa, always fill through the top-load filter. Only use regular tap water. **DO NOT USE SOFT WATER.**
12. When draining your spa, turn off the power to the spa and attach a garden hose to the hose bib fixture located on the floor of the equipment area.
13. Spas built in the winter months may be delivered with the bleeder valves removed from the pumps and taped inside the control box. We remove the bleeder valves after water testing at the factory, to prevent possible freeze damage during shipping. Prior to filling your spa for the first time, make sure you replace the air bleeder valves and check the equipment area for any unions that might have loosened during shipment.
14. In addition to your portable spas' redwood skirt, you may have purchased a gazebo, cabana, steps or any other redwood accessory. We recommend that you protect them by applying a high quality redwood protectant, and repeat as specified on the directions. This is mandatory to maintain warranty coverage.

# Quick Reference Information:

## Set Up and Delivery:

### Electrical:

1. 110-Volt spas will require a 20 amp dedicated receptacle.
2. 220-volt spas will require a 50 amp dedicated GFCI circuit breaker.
3. See Pages 7 through 9 for more information.

### Surface and Pad Requirements for Spas and Gazebos:

1. Your new portable spa and or gazebo must be placed on a uniformly firm, flat and level concrete pad. We recommend a 3½" thick slab.
2. See Pages 4 and 6 for more information

## General Start-up Information:

### Portable Spas:

1. Once your spa is placed on an approved surface and is connected to the correct electrical service. Inspect all plumbing connections in the equipment area of your spa. These connections may have loosened in shipment.
2. If equipped, open all gate valves or slice valves in the equipment area.
3. Note: When operating the spa these valves must be in the up or open position.
4. Install filter cartridge into filter housing.
5. To fill spa, place a garden hose into the skimmer area of the spa. Fill spa up to the fill "Water Level" line or half way up the skimmer area.
6. Open the air relief valve, located in the skimmer area of most system spas. On all other spas, use the air relief valve located on the front of the pump housing.
7. After the air bubbles stop coming out of the air relief valve, tighten valve until closed (Do not over tighten).
8. Once water level is at the correct water level, turn on the spa's power at the GFCI breaker.
9. 110-Volt spas are connected to the proper electrical outlet.
10. The spa will perform a diagnostic check and power up in 30 seconds.
11. All electronically controlled spas will default to 100°F and filter for four (4) hours twice a day.
12. Pneumatic spas in Freeze Protection Mode will operate and heat to the manual setting (where the thermostat is set). See Pneumatic Operating instructions on page 17 for more information.
13. The spa is now ready for use.

## Filter Cycle Set-up Information:

### Start-up

1. All electronically controlled spas will default to filter cycle mode "F4". This represents four (4) hours of filtration time every twelve (12) hours.
2. Filter cycles are started when the spa is powered up for the first time or any time the power is reset. I.e. the GFCI is tripped and reset, or there is a temporary power outage.
3. Filtration Settings and Recommendations:
  - a. F2 = Two (2) hours of filtration every twelve hours. This setting is for occasional spa usage. No more than two hours of usage in seven (7) days.
  - b. F4 = Four (4) hours of filtration every twelve hours. This setting is for light spa usage. No more than four hours of usage in seven (7) days.
  - c. F6 = Six (6) hours of filtration every twelve hours. This setting is for normal spa usage. No more than four hours of usage in seven (7) days.
  - d. F8 = Eight (8) hours of filtration every twelve hours. This setting is for heavy usage. No more than four hours of usage in seven (7) days.  
Note: This setting is only to be used with the "Spa Cal Filtration System"
  - e. FC = Filter Continuous (24) hours of filtration. This setting is for maximum spa usage.  
Note: This setting is only to be used with the "Spa Cal Filtration System"



## Quick Reference Information: (Continued)

4. To set the filtration cycles use the following information:
  - a. 2100 Depress the TEMP pad followed by the JETS. Each additional press of the TEMP pad will increase the filtration time.
  - b. 2200 Depress either Up or Down followed by either the JETS 1 or Jets 2. Each additional press of the Up or Down pad will increase or decrease the filtration time.
  - c. 2300 Depress either Up or Down followed by either the JETS 1 or Jets 2. Each additional press of the Up or Down pad will increase or decrease the filtration time.

## General Chemical Maintenance Information: (500-Gallon Spa)

### Start-up

- a. Add 16.oz of "Metal Protector"
- b. Add 2 oz of "Sodium Bromide"
- c. Add 2 oz of "Oxidizer Shock"
- d. Add 3 to 4 Bromine tablets to a mostly closed floater.

### Weekly

1. Test spa water with test strips for the following items twice a week:
  - a. Bromine: Acceptable Range without a Cal Zone Ozonator is between Three (3) to Five (5).
  - b. Bromine: Acceptable Range with a Cal Zone Ozonator is between One (1) to Three (3).
  - c. Chlorine: Acceptable Range without a Cal Zone Ozonator is between Three (3) to Five (5).
  - d. Chlorine: Acceptable Range with a Cal Zone Ozonator is between One (1) to Three (3).
  - e. pH: Expectable Range is between 7.2 to 7.8
  - f. Alkalinity: Acceptable Range is between 80 to 120
2. Add one to two bromine tablets. Usage varies with water temperature.
3. Add 2 oz. of "Oxidizing Shock". Always follow directions on the container.  
(Do not use chlorinating shock.)
4. Add 2 oz. "Stain & Scale Defense". Always follow directions on the container.
5. Add "pH Up" if needed. Always follow directions on the container.
6. Add "Alkalinity Up" if needed. Always follow directions on the container.
7. Add "pH Down" if needed. Always follow directions on the container.

### BI-Weekly

1. Follow weekly instructions, and the following.
2. Clean the filter cartridge. (See the "Filter Maintenance" section on pages 13 and 14)
3. Visually inspect the equipment area for the following:
  - a. Equipment area is clean. (Cabinet vents are unobstructed)
  - b. Ozonator operation. (Ozonator only operates during filtration cycles)
  - c. Pumps, Plumbing, Air Blowers, Unions, Gate valves, and Ozone check valves for leakage.

Note: Component failure as a result of leaks not promptly reported, will void the warranty.

### Important Chemical Notice:

Before the use of any chemicals, C.A.I. recommends all spa users consult with their physician for possible allergic reaction to chemicals. C.A.I. also recommends consulting with your local Cal Spa Dealer for a chemical program that is best suited your local water condition, climate, and usage habits.

# Set-Up and Delivery Instructions

## Getting Ready for Delivery and Set-up of Your New Cal Spa

### Planning For Delivery of Your Portable Spa:

- a. Your 110-Volt spa will require a 20 amp dedicated receptacle.
- b. Your 220-volt spa will require a 50 amp dedicated GFCI circuit breaker.
- c. If you have any doubts, have your electrical system checked by a qualified, licensed electrician.

### Surface and Pad Requirements for Spas and Gazebos:

- a. Your new portable spa and or gazebo must be placed on a uniformly firm, flat and level concrete pad. We recommend a 3½" thick slab. Gazebos assembled on surfaces either not flat or level will result in windows and doors closing improperly.
- b. If the location of your spa is going to be near a sprinkler system, make sure you adjust the sprinkler heads away from the spa. Water continually sprayed on spa cabinet or in equipment area may cause wood or electrical component damage.

### Requirements for Decking, Gates and Balconies:

- a. All decking must be able to support 150 pounds per square foot.
- b. Surrounding area gates must be self-closing and self-latching (California Requirements).
- c. Balconies must be constructed to current state and local code. (Spa load requirements are 150 pounds per square foot)

### Planning for Delivery of Your In-ground Spa:

- a. Selecting the right site for the installation of your in-ground spa and equipment is very important. These sites should be city and state approved, also considering the ease of access, landscaping, and architectural styling.

### The delivery crew will need following list of information prior to delivery of your spa:

- a. Clearance through gates, around gas meters, fireplace, air conditioners or other obstacles.
- b. Measure the height between ground and lowest point of roof eaves.

#### *External Equipment:*

- c. Measure the distance between the spa and equipment. (Including turns and obstacles)

#### *Inground Spas:*

- d. Finished height of spa lip. (From ground to bottom of lip)

## IMPORTANT

- ❖ ALWAYS HAVE A LICENSED CONTRACTOR /ELECTRICIAN INSTALL ALL EQUIPMENT.
- ❖ ALWAYS WATER TEST YOUR NEW IN-GROUND SPA FOR FIVE DAYS BEFORE COMPLETING ANY DECKING OR FINISH WORK.
  - ❖ DO NOT PLACE EQUIPMENT MORE THAN 20 FEET FROM SPA.
- ❖ DO NOT INSTALL EQUIPMENT HIGHER THAN SIX INCHES ABOVE WATER LEVEL, OR LOWER THAN THE BOTTOM OF THE SPA.
- ❖ LEAVE ALL TRENCHES OPEN FOR FINAL INSPECTION BY YOUR LOCAL INSPECTOR.

# 110 Volt Installation Information

Always Follow Applicable Local, State, and Federal Codes and Guidelines.

1. Use only a dedicated electrical line with a 20-amp breaker.
2. Do not use an extension cord.
3. Always use a weatherproof/covered receptacle.
4. Never have your spa closer than 10 feet to the receptacle.
5. Do not bury the power cord.
6. A damaged cord must be replaced before next usage.
7. All 110-volt spas include a GFCI plug. This GFCI plug should be tested prior to every use.

To test the GFCI, please follow these easy instructions:  
Note: Spa should be already plugged in and operational.

1. Press the button marked "Test" on the GFCI. The GFCI will trip and the spa will stop operating
2. Press the button marked "Reset" on the GFCI. The GFCI will reset and the spa will turn back on in about 5 seconds.
3. The spa is now safe to use.

If the GFCI should turn off (trip) while the spa is in use, press the reset button. If the GFCI will not reset, unplug the GFCI and call your local Showroom/Dealership for service. DO NOT USE SPA.

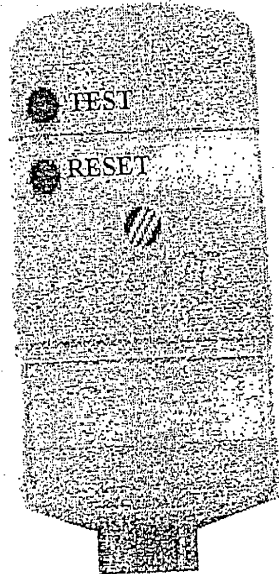

# 220 Volt Installation Information

All 220-volt spas are required to have a GFCI breaker and should only be wired by a licensed electrician. To ensure proper wiring of your GFCI, please follow the wire diagrams on pages 8 and 9.

1. Always Follow Applicable Local, State, and Federal Codes and Guidelines:
2. Your new 220 volt CAL SPA requires a DEDICATED 50 AMP GFCI SERVICE WITH FOUR # 6 AWG COPPER WIRES. This will include a black and red wire for your incoming power, a white wire used for your neutral and a green wire for your ground.
3. Please note that this is the only acceptable electrical wiring procedure. Spas wired other than what's stated in this manual will void your warranty.

Before each use of your spa you should check the GFCI. During this test the spa should be operational.

1. Press the test button on the GFCI. The GFCI will trip and the spa will shut off.
2. Wait 30 seconds and reset the GFCI breaker, this is done by turning the breaker off and then back on. Your spa will be operational in about 5 seconds.
3. Your spa is now safe to use.



## G.F.C. HOOK-UP

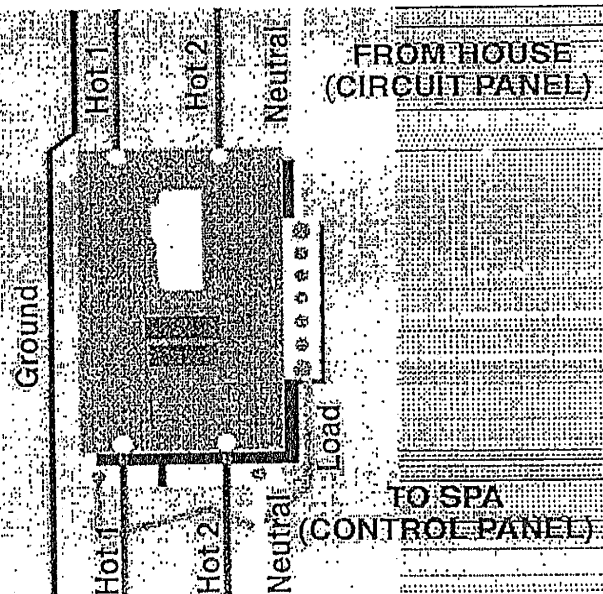

**CIRCUIT BREAKER PANEL**  
120/240V SOURCE

(HOUSE)

INPUTS FROM TRANSFORMER

NEUTRAL/GROUND BUS

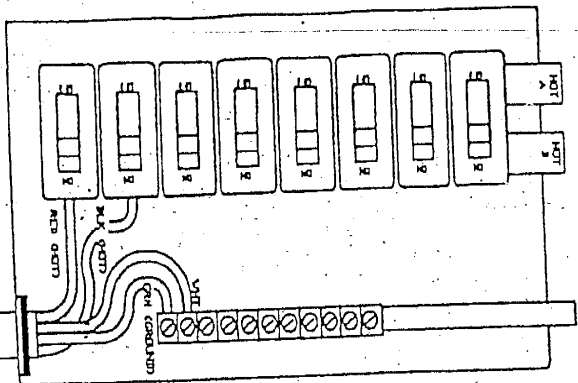

**G.F.I. HOOK-UP**

SPA  
120/240V LOAD

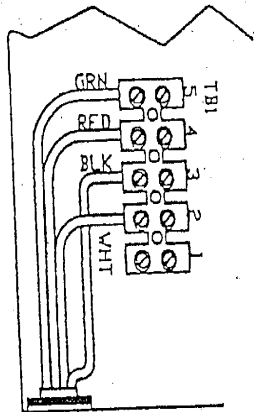

G.F.I.

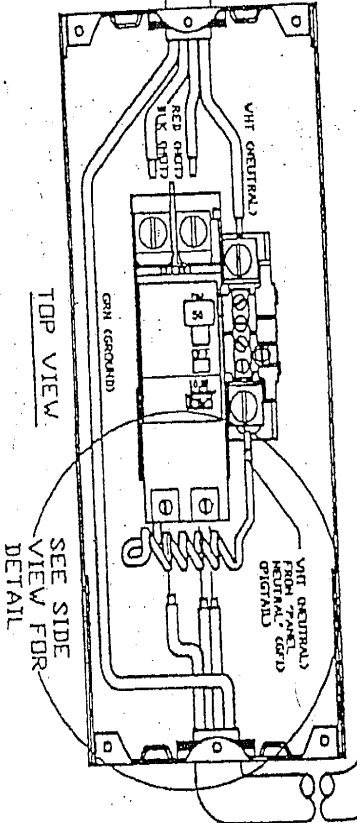

TOP VIEW

SEE SIDE VIEW FOR DETAIL

**SCHEMATIC DIAGRAM**

120/240V AS SOURCE

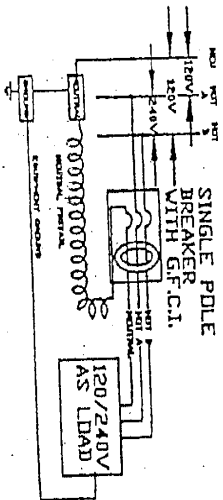

WHT (NEUTRAL) FROM TRANSFER NEUTRAL (OPTIONAL)

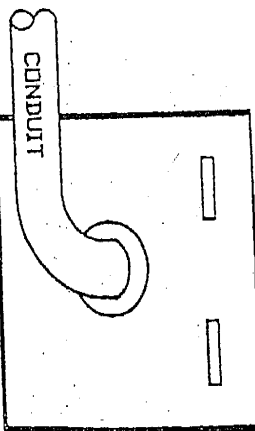

SIDE VIEW

# Starting Up Your Portable Spa:

## Filling and Powering-up Your Cal Spa:

1. Once spa is placed on an approved surface and is connected to the correct electrical service, inspect all plumbing connections in the equipment area of your spa. These connections may have loosened in shipment.
2. If equipped, open all gate valves or slice valves in the equipment area.  
Note: When operating the spa these valves must be in the up or open position.
3. Place a garden hose into the skimmer basket. Continue filling spa with **Regular Tap Water** until water level reaches the "Water Level" line or half way up the skimmer area.
4. Open the air relief valve, located in the skimmer area of most system spas. On all other spas, use the air relief valve located on the front of the pump housing.
5. After the air bubbles stop coming out of the air relief valve, tighten valve until closed (Do not over tighten).
6. Once water level is at the correct level, turn on the spa's power at the GFCI breaker.  
Note: 110-Volt spas are connected to the proper electrical outlet.
7. The spa will perform a diagnostic check for 30 seconds. Once complete, the spa will automatically operate at filter speed and continue heating until the spa water reaches 100°F. This is every electronically controlled spas default temperature.  
  
Note: Pneumatic spas will operate and heat to the manual setting (where the thermostat is set). See pneumatic operating instructions on page 17 for more information.
8. The spa is now ready for use.  
For operation instruction see the "Controls Operation" sections of this manual.

## Important Notes:

- Be careful not to over tighten plumbing fittings.
- Never run spa with gate valves closed or run pumps without water circulating for long periods of time.
- Never fill your spa with Soft Water. Soft water is very difficult to maintain correct chemical levels, foams, and can ultimately harm your spas finish and void your warranty.

# Starting Up Your Inground and Ported Spa:

## Filling and Powering-up Your Cal Spa:

1. Once spa is installed inground or placed on an approved surface and connected to the correct electrical service, you can proceed with these instructions
2. If equipped, open all gate vales or slice valves.
3. Note: When operating the spa these valves must be in the up or open position.
4. Place a garden hose into the skimmer basket. Continue filling spa with **Regular Tap Water** until water level reaches the "Water Level" line or half way up the skimmer area.
5. Remove lid(s) from pump basket(s) and filter canister.
6. Fill pump basket(s) and external filter canister with a garden hose until full and replace lids snug.
7. Once water level is at the correct level, pump baskets, and external filter canister are full of water, turn on the spa's power at the GFCI breaker.
8. The spa will perform a diagnostic check for 30 seconds. Once complete, the spa will automatically operate at filter speed and continue heating until the spa water reaches 100°F. This is every electronically controlled spas default temperature.
9. For information on adjusting temperature setting, see the "Controls Operation" sections of this manual.
10. Note: Pneumatic spas will operate and heat to the manual setting (where the thermostat is set). See Pneumatic operating instructions on page 17 for more information.
11. The spa is now ready for use.  
For operation instruction see the "Controls Operation" sections of this manual.

## Important Notes:

- Be careful not to over tighten plumbing fittings, filters, and pump basket lids.
- Never run spa with gate valves closed or run pumps without water circulating for long periods of time.
- Never fill your spa with Soft Water. Soft water is very difficult to maintain correct chemical levels, foams, and can ultimately harm your spas finish and void your warranty.

## Chemical Maintenance:

Proper chemical maintenance is essential to healthy clean water and overall spa life. The following information is designed to assist with both, as well as ensure your warranty coverage.

Neglecting or abusing the chemical levels in your spa will void your warranty. So please read and follow these instructions carefully.

### Chemicals not allowed in your spa:

Never use the following chemical in your spa.

1. Acid's of any kind
2. Chlorine tablets
3. Liquid Chlorine
4. Tri-Chlor
5. Chlorinating Shock

### Cal Spas Recommended Chemical Program: (500-Gallon Spa)

#### Start-up:

- a. Add 16.oz of "Metal Protector"
- b. Add 2 oz of "Sodium Bromide"
- c. Add 2 oz of "Oxidizer Shock"
- d. Add 3 to 4 Bromine tablets to a "mostly" closed floater.

#### Weekly:

1. Test spa water with test strips for the following items twice a week:
  - a. Bromine: Acceptable Range without a Cal Zone Ozonator is between Three (3) to Five (5).
  - b. Bromine: Acceptable Range with a Cal Zone Ozonator is between One (1) to Three (3).
  - c. Chlorine: Acceptable Range without a Cal Zone Ozonator is between Three (3) to Five (5).
  - d. Chlorine: Acceptable Range with a Cal Zone Ozonator is between One (1) to Three (3).
  - e. pH: Expectable Range is between 7.2 to 7.8
  - f. Alkalinity: Acceptable Range is between 80 to 120
2. Add one to two bromine tablets. Usage varies with water temperature and bather loads.
3. Add 2 oz. of "Oxidizing Shock". Always follow directions on the container.  
(Do not use chlorinating shock.)
4. Add 2 oz. "Stain & Scale Defense". Always follow directions on the container.
5. Add "pH Up" if needed. Always follow directions on the container.
6. Add "Alkalinity Up" if needed. Always follow directions on the container.
7. Add "pH Down" if needed. Always follow directions on the container.

#### BI-Weekly:

1. Follow weekly instructions, and the following.
2. Clean the filter(s) cartridges. (See the "Filter Maintenance" section on pages 13 and 14)
3. Visually inspect the equipment area for the following:
  - a. Equipment area is clean. (Cabinet vents are unobstructed)
  - b. Ozonator operation. (Ozonator only operates during filtration cycles)
  - c. Pumps, Plumbing, Air Blowers, Unions, Gate valves, and Ozone check valves for leakage.

Note: Component failure as a result of leaks not promptly reported, will void the warranty.

#### Important Chemical Notice:

Before the use of any chemicals, C.A.I. recommends all spa users consult with their physician for possible allergic reaction to chemicals. C.A.I. also recommends consulting with your local Cal Spa Dealer for a chemical program that is best suited your local water condition, climate, and usage habits.



## Chemical Maintenance: (Continued)

### Monthly:

1. Deep clean your filter cartridge with a Cal Spa approved filter clean chemical.

### Every Four to Six Months: (Or as needed)

1. Drain, clean, and polish spa with Cal Spa approved chemicals.
2. When refilling, follow "Start-up procedures listed above.

Cal Spas recommends the use of "Cal Spa Chemicals". These chemicals are specifically manufacture for Cal Spas. When used properly, they will protect your spa investment and maintain warranty coverage. Ask your spa dealer for official Cal Spa Chemicals.

## Filter Maintenance:

### Portable Spas

Filtration starts on electronically controlled spas as soon as the pumps are primed and water flow is steady. As the flow of water goes through the filter, dirt and debris is removed and accumulated in the filter cartridge. As the filter cartridge accumulates minerals, dirt and debris, water flow is lessened and jet performance is reduced. This can cause your spa not to run or heat properly.

### Clean Your Filter Regularly, and Replace as Needed

#### Filter Cleaning:

Your new Cal Spa has been designed for quick and easy filter maintenance. The filter cartridge should be cleaned once a week.

1. Turn power off at the breaker.
2. Remove filter cover. (If equipped)
3. Remove filter basket. (Align flat areas on filter basket and canister)
4. Remove filter, (Pull up and Out) and clean with a garden hose.
  - a. Hold filter vertically.
  - b. Spray filter cartridges with a pressure nozzle, starting from the top and spraying down each pleat.
  - c. Turn filter cartridge over and repeat step (4b).
  - d. Reinstall filter cartridge in reverse order of removal.
5. Deep clean filter cartridge every month. Use a Cal Spa approved filter-cleaning chemical.

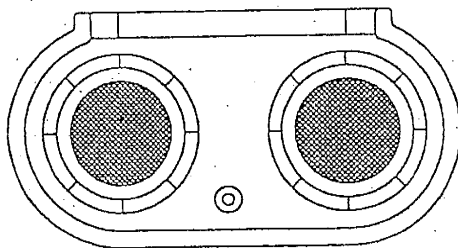

*Spa Cal Filtration System*

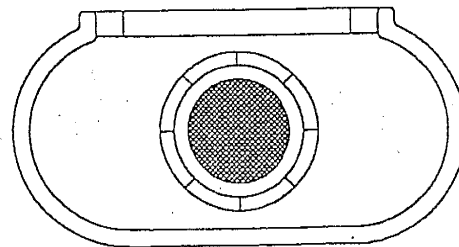

*Standard Filtration System*

## Filter Maintenance:

### Inground Spas (Out Door Equipment)

1. Turn off power at breaker.
2. If your spa is equipped with a spa side filter canister in addition to the external equipment mounted canister, please follow the portable filter maintenance steps on page 14 in addition to the steps listed below.
3. Close all gate valves (if equipped: down = closed).
4. Unscrew lid on the pump baskets.
5. Remove the lint traps inside and spray clean with a pressure nozzle attached to a garden hose.
6. Remove lock nut from top of filter external canister.
7. Remove filter cartridge. (pull-up and Out)
  - a. Hold filter vertically.
  - b. Spray filter cartridges with a pressure nozzle, starting from the top and spraying down each pleat.
  - c. Turn filter cartridge over and repeat step (4b).
  - d. Reinstall filter cartridge in reverse order of removal.
6. Deep clean filter cartridge every month. Use a Cal Spa approved filter-cleaning chemical.

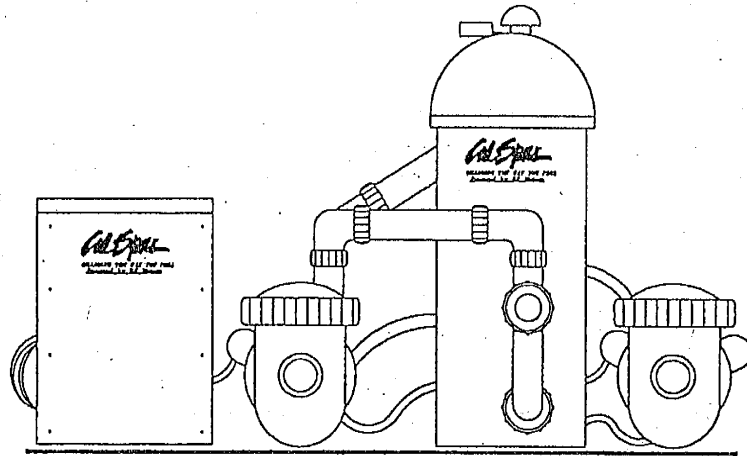

# General Operating Instructions

Your new Cal Spa is very versatile; you can direct the flow of water and air through various locations in your spa. The following lists of features are available on most spas:

## Air Venturies

Air Venturies are the smaller knobs located around the top of your spa. Each one will let you add a mixture of air in with the jet pressure. This is accomplished by simply rotating the air venturi handle to the left (Counter clockwise), decreasing the amount of airflow through the jets. To increase the amount of airflow through the jets, simply rotate the handle to the right (Clockwise).

Multiple air venturies allow you to add or turn off the air in different sections of the spa.

Note: The Air Venturi system may not be controlled on spas with the optional Turbo System.

## Air Venturies

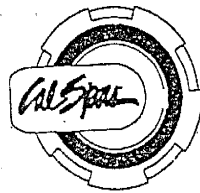

## Adjustable Jets

Almost all of the Jets in your spa are adjustable. Rotating the face of an adjustable jet to the left (Counter clockwise) will increase the amount of water flow through the jet. Rotating the face of an adjustable jet to the right (Clockwise) will decrease the amount of water flow through the jet.

## Adjustable Jets

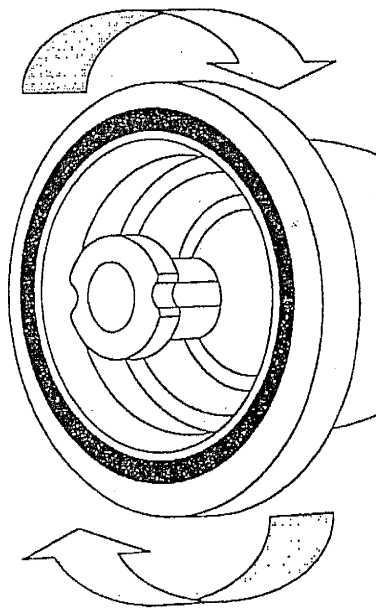

## General Operating Instructions: (Continued)

### Diverter Knobs:

Diverter knobs are the larger knobs located around the top of your spa. They allow you to divert water through jets from one side of the spa to the other. Or in most cases from "Floor Jets" to Wall Jets". This is accomplished by simply rotating the diverter handle to the left (Counter clockwise), decreasing the amount of water flow through a section of jets. To increase the amount of water flow through the other section of jets, simply rotate the handle to the right (Clockwise).

### Diverter Knob

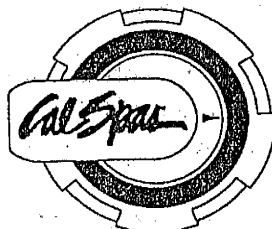

### Cal Zone Ozonator:

Your new Cal Zone Ozonator is a state of the art bacteria-killing machine. This unit will assist you with maintaining clean and clear spa water, while saving you time and expense with spa chemicals.

#### Operation:

Your Cal Zone ozonator will automatically operate during filter cycles. When the spa is in one of its filtration cycles the Ozone Indicator light on the topside control panel will light up, letting you know that the control box is sending power to the Cal Zone Quest 2000 Ozonator unit.

The Cal Zone ozonator unit also has two forms of operating signals. On the topside control panel there is a green light labeled OZONE INDICATOR. This light signals that the Cal zone unit is receiving power from the control box. The second operating signal is the most important. Located on the front side towards the bottom, is the ozone-mixing chamber. When operating the lens will display a purple / black light. This light and energy is creating ozone in front of your eyes.

Note: Due to the nature of the ozone light, it is difficult to see in the daylight. This lens should be checked at night or in a shaded condition.

Ozone Servicing: Your new Cal Zone ozonator has been engineered to be service friendly. In the event that you need to replace the ozone cartridge, simply follow the instructions listed on the front of the ozone unit.

### Cal Zone Quest 2000 Ozonator

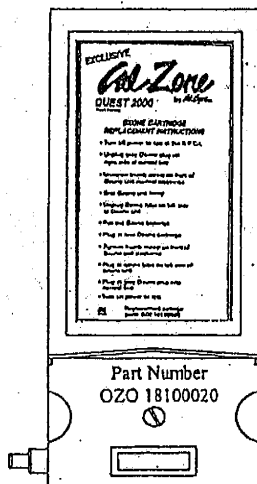

# Pneumatic Operation

## Pneumatic Topside Control Panel



### Control Box Features

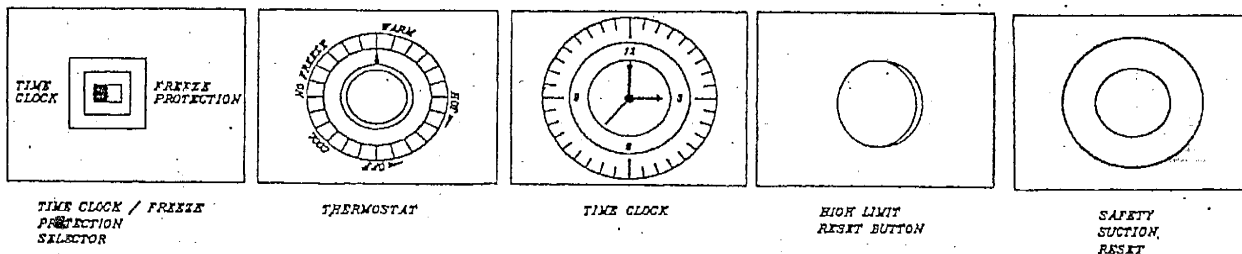

#### Start up

When first powered up, flip the selector switch to the Freeze Protection Mode and the spa will run and heat to the temperature the thermostat is positioned to.

#### Time Clock / Freeze Protection:

##### Freeze Protection Mode:

When in this mode, the thermostat will automatically maintain the water temperature that the thermostat is set to. The filter speed of the pump and heater will operate whenever the spa water drops by more than 2° F. This will ensure that your desired water temperature is always maintained.

##### Time Clock Mode:

When in this mode, the temperature will only be maintained during the time that you have set on the time clock. See the Time Clock Operation section below for setting instructions.

#### Temperature Adjustment:

Rotate the thermostat knob from OFF to HOT to find desired water temperature. Range of water temperature will be from OFF to 104°F in the HOT position.

#### Time Clock Operation:

Filtration of the spa water is accomplished any time the pump is running. To set personal filtration time, simply press the white tabs towards the center of the time clock. Each white tab equals (15) fifteen minutes of filtration and heating time. Cal Spas recommends that filter setting of two (2) to four (4) hours twice a day.

## **Pneumatic Operation: (Continued)**

### **Hi Limit:**

Your spa is equipped with a high limit safety switch that will automatically shut down the spa in the unlikely event of an overheat situation. To reset the Hi Limit, simply push the Hi-limit button in until it stops, and the spa will restart itself.

### **Safety Suction System:**

Your spa is equipped with a Safety Suction System that will automatically shut down the spa in the event of a blockage of a suction fitting or filter obstruction. To reset the Safety Suction System, simply push the button located on the right side of the control box, and the spa will restart itself.

### **Jet Controls:**

Depress the Jet button(s) to activate the high-speed pump(s). Depress the Jet button again to turn off the high-speed pump(s).

### **Light:**

Depress the Light button to turn on the spa light. Depress the Light button again to turn off the spa light.

### **Turbo: (Optional)**

Depress the Turbo button to turn on the spa Turbo System. Depress the Turbo button again to turn off the turbo system.

### **120 / 240 Volt Toggle Switch: (Optional)**

Convertible control boxes include a 120 /240 Volt toggle switch located on the left side of the control box. This switch is used to control the heating element at different voltages.

### **Toggle Switch Position:**

UP = 120-Volt Position

Down = 240-Volt Position

Note: Toggle switch in the wrong position could trip the GFCI.

# 2100 Electronic Operation

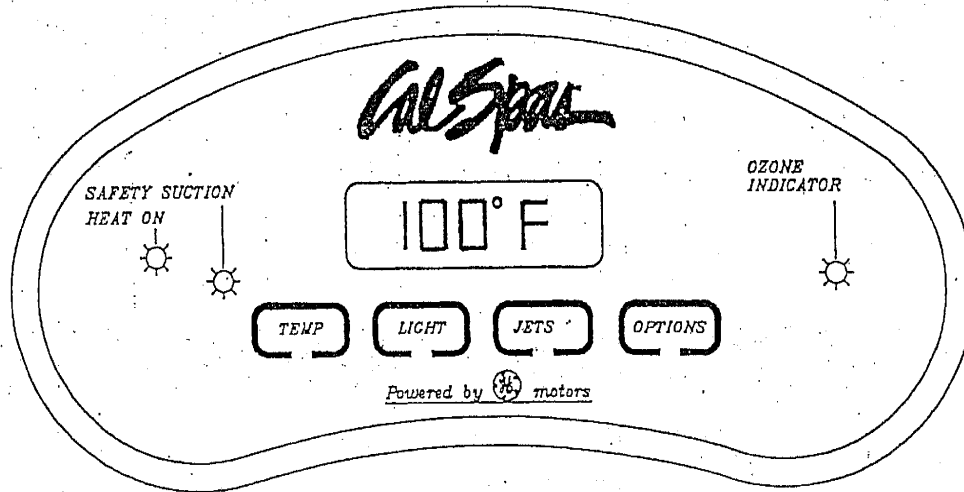

## Initial Start up

When first powered up, the system will perform a self-diagnostic check, then will automatically heat and maintain 100°F until you change the set temperature as listed in the Temperature Adjustment section.

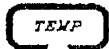

### Temperature Adjustment (Range 80°F to 104°F)

The display screen will always display the actual water temperature.

To display the temperature that the spa is set to, simply depress the Temp pad. The set temperature will be flashing on the display panel. When the display is flashing, each time you depress the Temp pad will change the set temperature either up or down by one degree. Letting the display revert back to the actual water temperature, then depressing the Temp pad again will allow you to change the direction of temperature adjustment.



### Standard and Economy Modes

Your new spa is equipped with a Standard and Economy heating feature that gives you complete control of the heating system.

When the spa is powered up, it will automatically start in "Standard Heating Mode". In this mode, the heating system will automatically activate whenever the water temperature drops more than one degree below the set temperature. In the "Economy Heating Mode" the heating system will only activate during filtration times. (Filtration times are set by using the "Setting Filtration Cycles" section on page 21.)

To switch from the "Standard Heating Mode" to the "Economy Heating Mode", simply depress the Temp pad followed by the Light pad. Depress the same sequence to switch back to the "Standard Heating Mode". Once in the "Economy Heating Mode", **EC** will be displayed in the center of the topside control panel and flash alternately of the water temperature. This is to inform you of what heating mode you are currently in.

Note: There is not a topside control panel message displayed when in the "Standard Heating Mode". Only the actual water temperature will be displayed.

## Electronic 2100 Operation (cont.)



### Jet Controls

One pump equipment:

Depress the Jets pad once to activate low speed. Depress the pad again to activate the high-speed. Depress the pad a third time to turn off the high-speed.

One pump equipment with circulation pump:

Depress the Jets pad once to activate the circulation pump. Depress the pad again to activate the circulation pump and the high-speed pump. Depress the pad a third time to turn off both the circulation pump and the high-speed pump.

Two pump equipment without circulation pump:

Depress the Jets pad once to activate low speed pump. Depress the pad again to activate high-speed on pump 1. Depress the pad a third time to activate the high-speed on pump 1 and high-speed on pump 2. Depress the pad a fourth time and only the high-speed on pump 2 will be on. Depress the pad a final time to turn pump 2 high-speed off.

Two pump equipment with circulation pump:

Depress the Jets pad once to activate the circulation pump. Depress the pad again to activate the circulation pump and the high-speed pump 1. Depress the pad a third time and the circulating pump, high-speed pump 1 and high-speed pump 2 will be on. Depress the Jets pad a fourth time and only the high-speed pump 2 will be activated. Depress the pad a final time to turn off pump 2 high-speed.

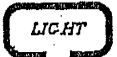

### Lights

Depress the Light pad to turn on the spa light and again to turn the light off.

*Optional Lighting:*

All optional lighting such as the "Control Panel Light" and "Cabinet Perimeter Lighting" is controlled by the Light pad and will turn on and off with the spa light.

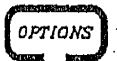

Turbo (Optional)

Depress the Option pad once to activate the Turbo system. Depress the Option pad again to turn off the Turbo system.



Setting the Temperature lock:

This feature allows you to lock-in a temperature into the system. When engaged the set temperature will blink on and off when the Temp pad is depress. However, the user will not be able to change the set temperature. Using the steps listed below you can lock or unlock the set temperature.

Depress the Temp pad, and then depress the Option pad to lock the set temperature in. Depress the same sequence to unlock.

Automatic Time outs

The low-speed or (optional) circulation pump will automatically turn itself off after 15 minutes if not turned off manually.

Either high-speed pump will automatically turn itself off after 15 minutes if not turned off manually.

The optional turbo will automatically turn itself off after 15 minutes if not turned off manually.

The light will automatically turn itself off after 15 minutes if not turned off manually.



## Electronic 2100 Operation (cont.)



### Setting Filtration Cycles:

Your spa will automatically filter itself twice a day. To set filtration time, turn off the power to the spa at the time of day you would like to start filtration. The first cycle will start after the spa is powered up. The second filter cycle will begin twelve hours later. Filter cycle duration is preset for 4 hours (F4). To change duration of filtration time, depress the Temp pad, then press the Jets pad. Depress the Temp button again to choose from 2,4,6,8, and 12 hours twice a day. (FC = Filtration Continuous) After selecting the desired filtering duration, depress the Jets pad to exit the filter program. The circulating pump and ozone generator (optional) will run during filter cycles.

Note: The filter cycles settings of F8 and FC are only intended for use with the optional "Spa Cal Filtration System".



### Safety Suction System

Your new Cal Spa is equipped with a state of the art "Safety Suction System." This will automatically shut the spa down in the event of filtration or suction restriction and display SF on the topside control panel. If this happens, check all suction fittings and filter cartridge(s) for obstructions. Then reset the system by depressing any topside pad.

## Self-Diagnostics Display Messages for Electronic 2100 Spas

Message	Meaning	Action Required
<p><b>Ec</b> (Flashing)</p>	<p>"Economy Heating Mode" When flashes alternately of the water temperature, your spa is in the Economy Heating Mode.</p>	<p>This message does not indicate the need for service. For more information see the Standard and Economy Mode Section on page 19.</p>
<p><b>OH</b></p>	<p>"Overheat" The spa has shut down. Either the spa has reached 112°F or the High-limit sensor has detected 118°F in the heater manifold.</p>	<p>DO NOT ENTER THE SPA WATER. Remove the spa cover and let the water cool. At 110°F, the spa should automatically reset. If the spa does not automatically reset, press any pad on the topside panel. If the spa still won't reset, turn off the power and call your local service center.</p>
<p><b>FLO</b></p>	<p>"Flow" A pressure switch has detected a loss of water flow.</p>	<p>Check the filter for debris. If dirty clean. (See pages 13 and 14 for cleaning instructions.) If problem persist, call your local service center.</p>
<p><b>SF</b></p>	<p>"Safety" Spa is shut down. The safety suction system has activated.</p>	<p>Check the drains and filter for debris or obstructions. To reset the system press any pad on the topside.</p>
<p><b>Sn</b></p>	<p>"Sensor" Spa is shut down. High-limit / Temperature sensor has malfunctioned.</p>	<p>Call your local service center.</p>

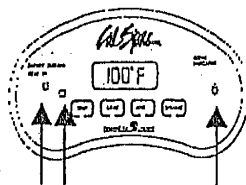

"LED's" These LED lights are used to inform you of feature operation.

These are not service indicators.

# 2200 Electronic Operation

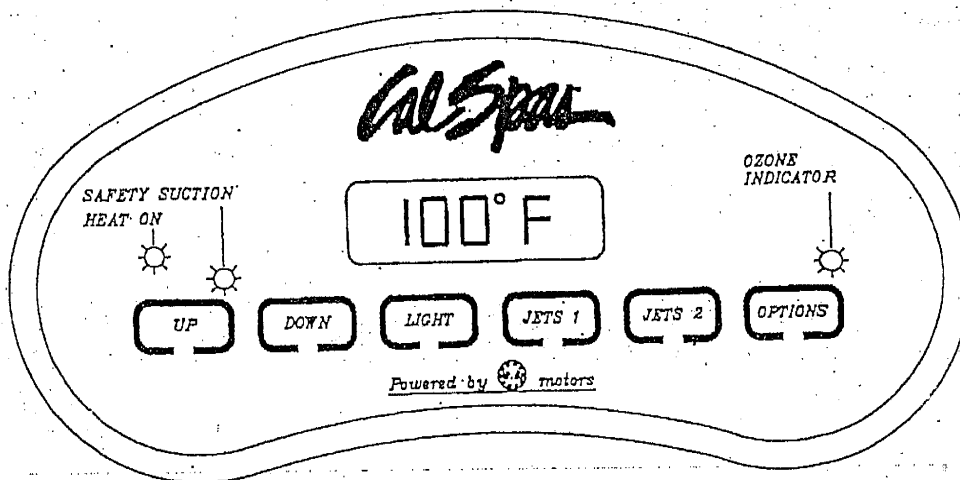

## Initial Start up

When first powered up, the system will perform a self-diagnostic check, then will automatically heat and maintain 100°F until you change the set temperature as listed in the Temperature Adjustment section.



## Temperature Adjustment (Range 80°F to 104°F)

The display screen will always display the actual water temperature.

To display the temperature that the spa is set to, simply depress either the Up or Down pad. The set temperature will be flashing on the display panel. When the display is flashing, each time you depress either the Up or Down pad, the set temperature will change up or down one degree.



## Standard and Economy Modes

Your new spa is equipped with a Standard and Economy heating feature that gives you complete control of the heating system.

When the spa is powered up, it will automatically start in "Standard Heating Mode". In this mode, the heating system will automatically activate whenever the water temperature drops more than one degree below the set temperature. In the "Economy Heating Mode" the heating system will only activate during filtration times. (Filtration times are set by using the "Setting Filtration Cycles" section on page 25.)

To switch from the "Standard Heating Mode" to the "Economy Heating Mode", simply depress either the Up or Down pad followed by the Light pad. Depress the same sequence to switch back to the "Standard Heating Mode".

Once in the "Economy Heating Mode", **EC** will be displayed in the center of the topside control panel and flash alternately of the water temperature. This is to inform you of what heating mode you are currently in.

Note: There is not a topside control panel message displayed when in the "Standard Heating Mode". Only the actual water temperature will be displayed.

## Electronic 2200 Operation (cont.)

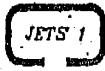

### Jets 1 Controls

#### *Without Circulation Pump Option:*

Depress the Jets 1 pad once to activate low speed. Depress the pad again to activate the high-speed. Depress the Jets 1 pad a third time to turn off the high-speed.

#### *With Circulation Pump Option:*

Depress the Jets 1 pad once to activate the high-speed pump. Depress the Jets 1 pad again to turn off the high-speed pump.

#### *Circulation Pump and Two Speed Pump Option:*

Depress the Jets 1 pad once to activate low speed. Depress the pad again to activate the high-speed. Depress the Jets 1 pad a third time to turn off the high-speed.

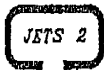

### Jets 2 Controls

#### *One Speed Pump:*

Depress the Jets 2 pad once to activate the high-speed pump. Depress the Jets 2 pad again to turn off the high-speed pump.

#### *Two Speed Pump Option:*

Depress the Jets 2 pad once to activate low speed. Depress the pad again to activate the high-speed. Depress the Jets 2 pad a third time to turn off the high-speed.

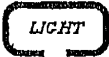

### Light

Depress the Light pad to turn on the light and again to turn the light off.

#### *Optional Lighting:*

All optional lighting such as the "Control Panel Light" and "Cabinet Perimeter Lighting" is controlled by the Light pad and will turn on and off with the spa light.

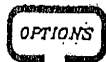

### Turbo (Optional)

Depress the Option pad once to activate the Turbo system. Depress the Option pad again to turn off the Turbo system.

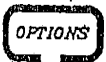

### Turbo and Mister (Multi Option)

Depress the Option pad once to activate the Turbo system. Depress the Option pad again to operate the Turbo and Mister system together. Depress the option pad a third time to turn off both the Turbo and mister system.



### Mister (Optional)

Depress the Option pad once to activate the Mister system. Depress the Option pad again to turn off the Mister system.

## Electronic 2200 Operation (cont.)



### Setting the Temperature lock:

This feature allows you to lock-in a temperature into the system. When engaged the set temperature will blink on and off when either the Up or Down pad is depress. However, the user will not be able to change the set temperature. Using the steps listed below you can lock or unlock the set temperature.

Depress the either the Up or Down pad, and then depress the Option pad to lock the set temperature in.

Depress the same sequence to unlock.

### Automatic Time outs

The low-speed or (optional) circulation pump will automatically turn itself off after 15 minutes if not turned off manually.

Either high-speed pump will automatically turn itself off after 15 minutes if not turned off manually.

The optional turbo will automatically turn itself off after 15 minutes if not turned off manually.

The light will automatically turn itself off after 15 minutes if not turned off manually.



### Setting Filtration Cycles:

Your spa will automatically filter itself twice a day. To set filtration time, turn off the power to the spa at the time of day you would like to start filtration. The first cycle will start after the spa is powered up. The second filter cycle will begin twelve hours later. Filter cycle duration is preset for 4 hours (F4). To change duration of filtration time, depress either the Up or Down pad, then press either the Jets 1 or Jets 2 pad.

Depress the Temp button again to choose from 2,4,6,8, and 12 hours twice a day. (**FC**= Filtration Continuos) After selecting the desired filtering duration, depress the Jets pad to exit the filter program. The circulating pump and ozone generator (optional) will run during filter cycles.

Note: The filter cycles settings of F8 and **FC** are only intended for use with the optional "Spa Cal Filtration System".



### Safety Suction System

Your new Cal Spa is equipped with a state of the art "Safety Suction System." This will automatically shut the spa down in the event of filtration or suction restriction and display **SF** on the topside control panel. If this happens, check all suction fittings and filter cartridge(s) for obstructions. Then reset the system by depressing any topside pad.

## Self-Diagnostics Display Messages for Electronic 2200 Spas

### Message

### Meaning

### Action Required

**Ec**

(Flashing)

"Economy Heating Mode"  
When flashes alternately of  
the water temperature, your  
spa is in the Economy  
Heating Mode.

This message does not  
indicate the need for  
service. For more  
information see the  
Standard and Economy  
Mode Section on page 23.

**OH**

"Overheat" The spa has shut  
down. Either the spa has  
reached 112°F or the High-  
limit sensor has detected  
118°F in the heater  
manifold.

**DO NOT ENTER THE  
SPA WATER.** Remove  
the spa cover and let the  
water cool. At 110°F, the  
spa should automatically  
reset. If the spa does not  
automatically reset, press  
any pad on the topside  
panel. If the spa still won't  
reset, turn off the power  
and call your local service  
center.

**FLO**

"Flow" A pressure switch  
has detected a loss of water  
flow.

Check the filter for debris.  
If dirty clean. (See pages  
13 and 14 for cleaning  
instructions.) If problem  
persist, call your local  
service center.

**SF**

"Safety" Spa is shut down.  
The safety suction system  
has activated.

Check the drains and filter  
for debris or obstructions.  
To reset the system press  
any pad on the topside.

**Sn**

"Sensor" Spa is shut down.  
High-limit / Temperature  
sensor has malfunctioned.

Call your local service  
center.

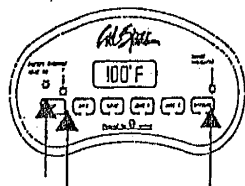

"LED's" These LED lights  
are used to inform you of  
feature operation.

These are not service  
indicators.

# 2300 Electronic Operation

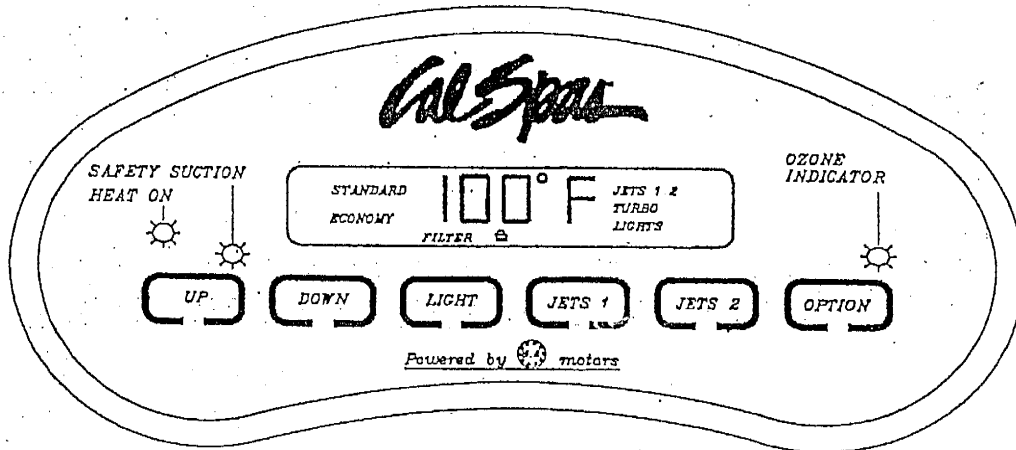

## Initial Start up

When first powered up, the system will perform a self-diagnostic check, then will automatically heat and maintain 100°F until you change the set temperature as listed in the Temperature Adjustment section.



## Temperature Adjustment (Range 80°F to 104°F)

The display screen will always display the actual water temperature.

To display the temperature that the spa is set to, simply depress either the Up or Down pad. The set temperature will be flashing on the display panel. When the display is flashing, each time you depress either the Up or Down pad, the set temperature will change up or down one degree.



## Standard and Economy Modes

Your new spa is equipped with a Standard and Economy heating feature that gives you complete control of the heating system.

When the spa is powered up, it will automatically start in "Standard Heating Mode". This is displayed by STANDARD on the left side of the topside control panel. In this mode, the heating system will automatically activate whenever the water temperature drops more than one degree below the set temperature. In the "Economy Heating Mode" the heating system will only activate during filtration times. (Filtration times are set by using the "Setting Filtration Cycles" section on page 14.)

To switch from the "Standard Heating Mode" to the "Economy Heating Mode", simply depress either the Up or the Down pad followed by the Light pad. Depress the same sequence to switch back to the "Standard Heating Mode".

Once in the "Economy Heating Mode", ECONOMY will be displayed on the left side of the topside control panel. This is to inform you of what heating mode you are currently in.

## Electronic 2300 Operation (cont.)

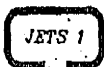

### Jet 1 Controls

#### *One Speed Pumps:*

Depress the Jets 1 pad once to activate the high-speed pump. Depress the Jets 1 pad again to turn off the high-speed pump.

#### *Two Speed Pump Option:*

Depress the Jets 1 pad once to activate low speed. Depress the pad again to activate the high-speed. Depress the Jets 1 pad a third time to turn off the high-speed.

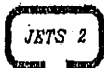

### Jet 2 Controls

#### *One Speed Pumps:*

Depress the Jets 2 pad once to activate the high-speed pump. Depress the Jets 2 pad again to turn off the high-speed pump.

#### *Two Speed Pump Option:*

Depress the Jets 2 pad once to activate low speed. Depress the pad again to activate the high-speed. Depress the Jets 2 pad a third time to turn off the high-speed.

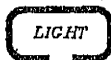

### Light

Depress the Light pad to turn on the light and again to turn the light off.

#### *Optional Lighting:*

All optional lighting such as the "Control Panel Light" and "Cabinet Perimeter Lighting" is controlled by the Light pad and will turn on and off with the spa light.

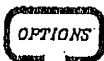

### Turbo (Optional)

Depress the Option pad once to activate the Turbo system. Depress the Option pad again to turn off the Turbo system.

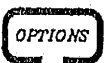

### Turbo and Mister (Multi Option)

Depress the Option pad once to activate the Turbo system. Depress the Option pad again to operate the Turbo and Mister system together. Depress the option pad a third time to turn off both the Turbo and mister system.

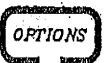

### Mister (Optional)

Depress the Option pad once to activate the Mister system. Depress the Option pad again to turn off the Mister system.



## Electronic 2300 Operation (cont.)



### Setting the Temperature lock:

This feature allows you to lock in a temperature into the system. When engaged the set temperature will blink on and off when either the Up or Down pads are depress. However, the user will not be able to change the set temperature. Using the steps listed below you can lock or unlock the set temperature. Depress the either the Up or Down pad, and then depress the Option pad to lock the set temperature in. Depress the same sequence to unlock.

### Automatic Time outs

The low-speed or (optional) circulation pump will automatically turn itself off after 15 minutes if not turned off manually.

Either high-speed pump will automatically turn itself off after 15 minutes if not turned off manually.

The optional turbo will automatically turn itself off after 15 minutes if not turned off manually.

The light will automatically turn itself off after 15 minutes if not turned off manually.



### Setting Filtration Cycles:

Your spa will automatically filter itself twice a day. To set filtration time, turn off the power to the spa at the time of day you would like to start filtration. The first cycle will start after the spa is powered up. The second filter cycle will begin twelve hours later. Filter cycle duration is preset for 4 hours (F4). To change duration of filtration time, depress either the Up or Down pad, then press either Jets 1 or Jets 2 pad.

Depress either the Up or Down pad again to choose from 2,4,6,8, and 12 hours twice a day. (**FC** = Filtration Continuos) After selecting the desired filtering duration, depress the Jets pad to exit the filter program. The circulating pump and ozone generator (optional) will run during filter cycles.

When the spa is operating in filtration mode, **FILTER** will be displayed at the bottom of the topside control panel and the Ozone Indicator Light will be on.

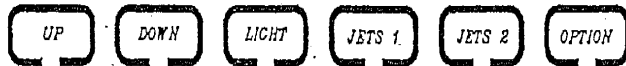

### Safety Suction System

Your new Cal Spa is equipped with a state of the art "Safety Suction System." This will automatically shut the spa down in the event of filtration or suction restriction and display **SF** on the topside control panel. If this happens, check all suction fittings and filter cartridge(s) for obstructions. Then reset the system by depressing any topside pad.

# Self-Diagnostics Display Messages for Electronic 2300 Spas

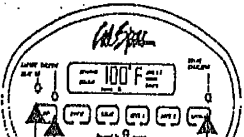
Message	Meaning	Action Required
STANDARD	The spa is in the "Standard Heating Mode"	This message does not indicate the need for service.
ECONOMY	The spa is in the "Economy Heating Mode"	This message does not indicate the need for service.
JETS 1	Pump 1 is operating	This message does not indicate the need for service.
JETS 2	Pump 2 is operating	This message does not indicate the need for service.
TURBO	Turbo System is operating	This message does not indicate the need for service.
LIGHTS	The spa lights are on.	This message does not indicate the need for service.
FILTER	The spa is in the "Filtration Mode"	The spa is operating in the set filtration mode.
	The Temperature Lock is activated	This message does not indicate the need for service.
OH	"Overheat" The spa has shut down. Either the spa has reached 112°F or the High-limit sensor has detected 118°F in the heater manifold.	DO NOT ENTER THE SPA WATER. Remove the spa cover and let the water cool. At 110°F, the spa should automatically reset. If the spa does not automatically reset, press any pad on the topside panel. If the spa still won't reset, turn off the power and call your local service center.
FLO	"Flow" A pressure switch has detected a loss of water flow.	Check the filter for debris. If dirty clean. (See pages 13 and 14 for cleaning instructions.) If problem persists, call your local service center.
SF	"Safety" Spa is shut down. The safety suction system has activated.	Check the drains and filter for debris or obstructions. To reset the system press any pad on the topside.
Sn	"Sensor" Spa is shut down. High-limit / Temperature sensor has malfunctioned.	Call your local service center.
	"LED's" These LED lights are used to inform you of feature operation.	These are not service indicators.

## Winterizing

In many areas of the country the temperature drops below 32° F. If you live in these areas, we recommend you always have your spa full of water and running at normal spa temperatures (80° F to 100°F). This will help reduce the risk of freezing in your spa and your spa's equipment.

### IMPORTANT WARNING

If you find the need to drain your spa, please be aware of the potential of freezing in your spa's equipment and plumbing. Even if the directions below are followed perfectly, there is no guarantee that your spa will not suffer freeze damage.

#### Cold Climate Draining:

1. Open all filters and filter baskets.
2. Remove filter(s)
3. Drain your spa completely.
4. Remove drain plugs from the front of pump(s).
5. Disconnect the unions from both sides of the pump.
6. Use a wet/dry vacuum to blow any remaining water out of the jets and plumbing lines.
7. Use a soft towel to remove any remaining water in the spa, filter canister, and equipment area.
8. Cover your spa with a good spa cover and all-weather tarp, to ensure rain or snow can not enter the spa.
9. If you have a Gas Heater, you will need to follow the winterizing instructions for your particular heater in the owner's manual. This manual will be delivered inside your gas heater.

#### Draining Your Spa:

Your spa should be drained every 4 to 6 months, and refilled with fresh tap water. Here are two recommended methods of draining your spa.

##### Method one (Portable Spas)

1. Turn off power.
2. Open all filters and filter baskets.
3. Remove filter(s).
4. Hook up the female end of a garden hose to the spas drain fitting and the other end in a convenient place for draining. \*(Locate white hose in the bottom of the equipment area, remove cap and connect garden hose.)
5. Let spa drain completely, then remove garden hose and replace the drain cap.

